



# HER1001G THRU HER1008G

10.0 AMPS. Glass Passivated High Efficient Rectifiers



Voltage Range  
50 to 1000 Volts  
Current  
10.0 Amperes

## Features

- ✧ Low forward voltage drop
- ✧ High current capability
- ✧ High reliability
- ✧ High surge current capability

## Mechanical Data

- ✧ Case: TO-220 molded plastic
- ✧ Epoxy: UL 94V-O rate flame retardant
- ✧ Terminals: Leads solderable per MIL-STD-202, Method 208 guaranteed
- ✧ Polarity: As marked
- ✧ High temperature soldering guaranteed: 260°C/10 seconds .16", (4.06mm) from case.
- ✧ Weight: 2.24 grams

## TO-220

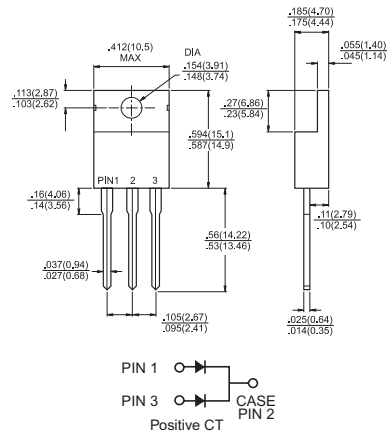

Dimensions in inches and (millimeters)

## Maximum Ratings and Electrical Characteristics

Rating at 25°C ambient temperature unless otherwise specified.

Single phase, half wave, 60 Hz, resistive or inductive load.

For capacitive load, derate current by 20%

Type Number	Symbol	HER 1001G	HER 1002G	HER 1003G	HER 1004G	HER 1005G	HER 1006G	HER 1007G	HER 1008G	Units
Maximum Recurrent Peak Reverse Voltage	$V_{RRM}$	50	100	200	300	400	600	800	1000	V
Maximum RMS Voltage	$V_{RMS}$	35	70	140	210	280	420	560	700	V
Maximum DC Blocking Voltage	$V_{DC}$	50	100	200	300	400	600	800	1000	V
Maximum Average Forward Rectified Current @ $T_C = 100^\circ\text{C}$	$I_{(AV)}$	10.0								A
Peak Forward Surge Current, 8.3 ms Single Half Sine-wave Superimposed on Rated Load (JEDEC method)	$I_{FSM}$	125								A
Maximum Instantaneous Forward Voltage @ 5.0A	$V_F$	1.0		1.3		1.7				V
Maximum DC Reverse Current @ $T_A=25^\circ\text{C}$ at Rated DC Blocking Voltage @ $T_A=125^\circ\text{C}$	$I_R$	10.0 400								 uA uA
Maximum Reverse Recovery Time (Note 1)	$T_{rr}$	50				80				nS
Typical Junction Capacitance (Note 2)	$C_j$	60				40				pF
Typical Thermal Resistance (Note 3)	$R_{\theta_{JC}}$	1.5								$^\circ\text{C}/\text{W}$
Operating Temperature Range	$T_J$	-65 to +150								$^\circ\text{C}$
Storage Temperature Range	$T_{STG}$	-65 to +150								$^\circ\text{C}$

Notes: 1. Reverse Recovery Test Conditions:  $I_F=0.5\text{A}$ ,  $I_R=1.0\text{A}$ ,  $I_{RR}=0.25\text{A}$

2. Measured at 1 MHz and Applied Reverse Voltage of 4.0 V D.C.

3. Mounted on Heatsink Size of 2 in x 3 in x 0.25 in Al-Plate.

## RATINGS AND CHARACTERISTIC CURVES (HER1001G THRU HER1008G)

FIG. 1- REVERSE RECOVERY TIME CHARACTERISTIC AND TEST CIRCUIT DIAGRAM

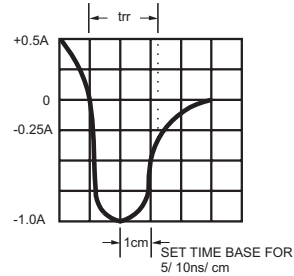
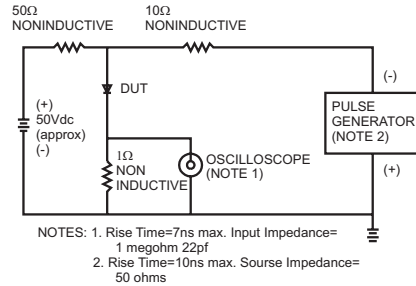

FIG. 2- MAXIMUM FORWARD CURRENT DERATING CURVE

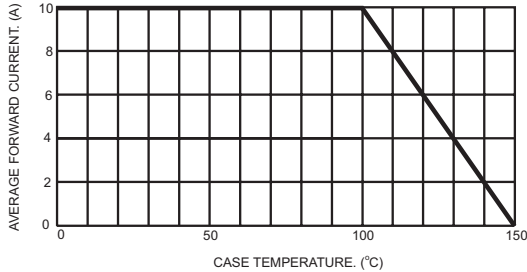

FIG. 3- TYPICAL REVERSE CHARACTERISTICS

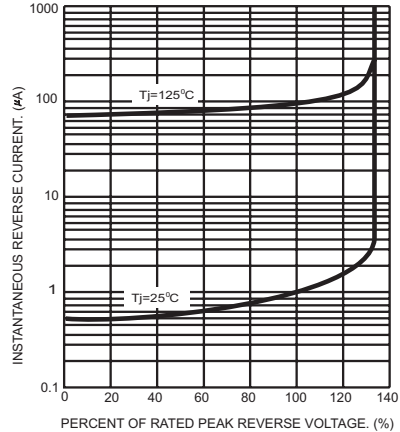

FIG. 4- MAXIMUM NON-REPETITIVE FORWARD SURGE CURRENT

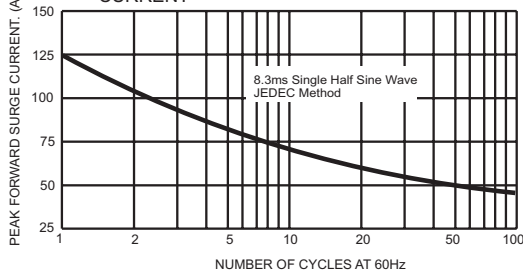

FIG. 6- TYPICAL FORWARD CHARACTERISTICS

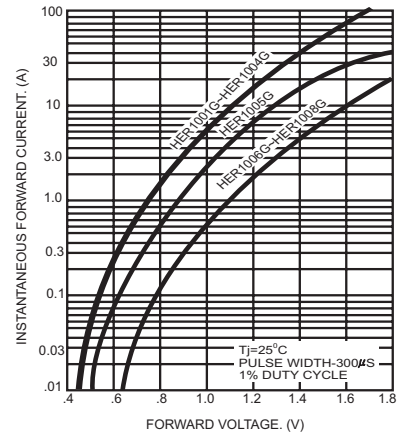

FIG. 5- TYPICAL JUNCTION CAPACITANCE

