

HA118104

T-77-07-05

3-circuit Video Switch

HA118104 is a 3-circuit, 2-contact video switch that features a clamp circuit and 6dB amplifier.

- Clamp circuit and 6dB amplifier on chip
- Outstanding frequency characteristics (cutoff frequency = 10MHz minimum)

Functions

- 5V single supply operation
- Applicable as a 75Ω driver
- Wide output dynamic range (2Vpp/150Ω)
- High-speed switching (50ns typ)
- Low power dissipation (95mW typ)



Ordering Information

Type No.	Package
HA118104	300mil 16-pin plastic DIP
HA118104FP	16-pin plastic SOP

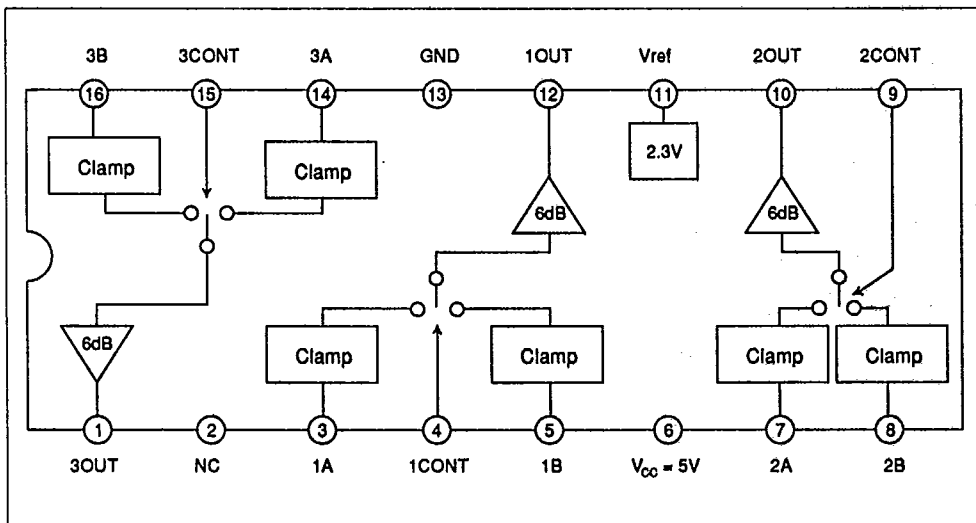
Block Diagram

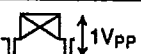
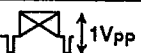
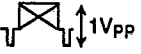
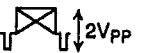
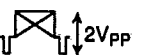
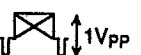

Pin Functions

Pin No.	Function	Ref. DC Voltage (V)	Signal Type	Signal Level	I/O Impedance
1	OUT3		Audio, video signal		Push-pull output
2	NC				
3	A1		Audio, video signal		Peak clamp
4	CONT1	5.0/0	Input switch signal		20kΩ
5	B1		Audio, video signal		Peak clamp
6	V _{CC}	5.0			
7	A2		Audio, video signal		Peak clamp
8	B2		Audio, video signal		Peak clamp
9	CONT2	5.0/0	Input switch signal		20kΩ
10	OUT2		Audio, video signal		Push-pull output
11	V _{rel}	2.3	DC		
12	OUT1		Audio, video signal		Push-pull output
13	GND	0			
14	A3		Audio, video signal		Peak clamp

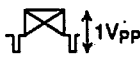

HA118104

Pin No.	Function	Ref. DC Voltage (V)	Signal Type	Signal Level	I/O Impedance
15	CONT3	5.0/0	Input switch signal		20kΩ
16	B3		Audio, video signal		Peak clamp

Note:
Values in this table are for reference only; they are not guaranteed values.



Absolute Maximum Ratings (Ta = 25°C)

Item	Symbol	HA118104	HA118104FP	Unit
Supply Voltage*1	V _{CC}	7.0	7.0	V
Input Terminal Voltage	V _{IN}	0 to V _{CC}	0 to V _{CC}	V
Power Dissipation*2	P _T	555	400	mW
Operating Temperature	Topr	-10 to +75	-10 to +75	°C
Storage Temperature	Tstg	-40 to +125	-40 to +125	°C

*1 Recommended supply voltage range: 4.9 to 5.5V

*2 Rated value at Ta = 75°C

Electrical Characteristics (V_{CC} = 5V, Ta = 25°C)

Item	Symbol	Min	Typ	Max	Unit	Test Condition	Remarks	Applicable Terminal
Supply Current	I _{CC}	11	19	26	mA	Quiescent Pins 4, 9, 15 OPEN		Pin 6
Reference Voltage	V _{ref}	2.07	2.27	2.47	V	OPEN terminal voltage		Pin 11
CONT1 Input Voltage L Level	V _{1L}	—	—	2.0	V		Pin 5 output	Pin 12
CONT1 Input Voltage H Level	V _{1H}	3.0	—	—	V		Pin 3 output	Pin 12
SW1A Input Voltage Gain 1	G _V 1A1	5.0	6.0	7.0	dB	V3 = 3.58MHz, 1Vpp R _L = ∞		Pin 12
SW1A Input Voltage Gain 2	G _V 1A2	4.8	5.8	6.8	dB	V3 = 3.58MHz, 1Vpp R _L = 150Ω		Pin 12
SW1B Input Voltage Gain 1	G _V 1B1	5.0	6.0	7.0	dB	V5 = 3.58MHz, 1Vpp R _L = ∞		Pin 12
SW1B Input Voltage Gain 2	G _V 1B2	4.8	5.8	6.8	dB	V5 = 3.58MHz, 1Vpp R _L = 150Ω		Pin 12
SW1 1A → 1B Crosstalk	CR 1A→1B	40	57	—	dB	V3 = 3.58MHz, 1Vpp V4 = L, R _L = ∞		Pin 12
SW1 1B → 1A Crosstalk	CR 1B→1A	40	57	—	dB	V5 = 3.58MHz, 1Vpp V4 = H, R _L = ∞		Pin 12
Input 1A Total Harmonic Distortion Factor	THD 1A	—	0.1	0.5	%	V3 = 1kHz, 1Vpp V4 = H, R _L = ∞		Pin 12
Input 1B Total Harmonic Distortion Factor	THD 1B	—	0.1	0.5	%	V5 = 1kHz, 1Vpp V4 = L, R _L = ∞		Pin 12



Item	Symbol	Min	Typ	Max	Unit	Test Condition	Remarks	Applicable Terminal
CONT1 Switching Speed 1A → 1B	SS 1A→1B	—	50	150	ns			Pin 12
CONT1 Switching Speed 1B → 1A	SS 1B→1A	—	50	150	ns			Pin 12
CONT2 Input Voltage L Level	V _{2L}	—	—	2.0	V		Pin 8 output	Pin 10
CONT2 Input Voltage H Level	V _{2H}	3.0	—	—	V		Pin 7 output	Pin 10
SW2A Input Voltage Gain 1	G _V 2A1	5.0	6.0	7.0	dB	V7 = 3.58MHz, 1Vpp V9 = H, R _L = ∞		Pin 10
SW2A Input Voltage Gain 2	G _V 2A2	4.8	5.8	6.8	dB	V7 = 3.58MHz, 1Vpp V9 = H, R _L = 150Ω		Pin 10
SW2B Input Voltage Gain 1	G _V 2B1	5.0	6.0	7.0	dB	V8 = 3.58MHz, 1Vpp V9 = L, R _L = ∞		Pin 10
SW2B Input Voltage Gain 2	G _V 2B2	4.8	5.8	6.8	dB	V8 = 3.58MHz, 1Vpp V9 = L, R _L = 150Ω		Pin 10
SW2 2A → 2B Crosstalk	CR 2A→2B	40	57	—	dB	V7 = 3.58MHz, 1Vpp V9 = L, R _L = ∞		Pin 10
SW2 2B → 2A Crosstalk	CR 2B→2A	40	57	—	dB	V8 = 3.58MHz, 1Vpp V9 = H, R _L = ∞		Pin 10
Input 2A Total Harmonic Distortion Factor	THD 2A	—	0.1	0.5	%	V7 = 1kHz, 1Vpp V9 = H, R _L = ∞		Pin 10
Input 2B Total Harmonic Distortion Factor	THD 2B	—	0.1	0.5	%	V8 = 1kHz, 1Vpp V9 = L, R _L = ∞		Pin 10
CONT2 Switching Speed 2A → 2B	SS 2A→2B	—	50	150	ns			Pin 10
CONT2 Switching Speed 2B → 2A	SS 2B→2A	—	50	150	ns			Pin 10
CONT3 Input Voltage L Level	V _{3L}	—	—	2.0	V		Pin 16 Output	Pin 1
CONT3 Input Voltage H Level	V _{3H}	3.0	—	—	V		Pin 14 Output	Pin 1
SW3A Input Voltage Gain 1	G _V 3A1	5.0	6.0	7.0	dB	V14 = 3.58MHz, 1Vpp V15 = H, R _L = ∞		Pin 1
SW3A Input Voltage Gain 2	G _V 3A2	4.8	5.8	6.8	dB	V14 = 3.58MHz, 1Vpp V15 = H, R _L = 150Ω		Pin 1
SW3B Input Voltage Gain 1	G _V 3B1	5.0	6.0	7.0	dB	V16 = 3.58MHz, 1Vpp V15 = L, R _L = ∞		Pin 1
SW3B Input Voltage Gain 2	G _V 3B2	4.8	5.8	6.8	dB	V16 = 3.58MHz, 1Vpp V15 = L, R _L = 150Ω		Pin 1



Item	Symbol	Min	Typ	Max	Unit	Test Condition	Remarks	Applicable Terminal
SW3 3A → 3B Crosstalk	CR 3A→3B	40	57	—	dB	V14 = 3.58MHz, 1Vpp V15 = L, R _L = ∞		Pin 1
SW3 3B → 3A Crosstalk	CR 3B→3A	40	57	—	dB	V16 = 3.58MHz, 1Vpp V15 = H, R _L = ∞		Pin 1
Input 3A Total Harmonic Distortion Factor	THD 3A	—	0.1	0.5	%	V14 = 1kHz, 1Vpp V15 = H, R _L = ∞		Pin 1
Input 3B Total Harmonic Distortion Factor	THD 3B	—	0.1	0.5	%	V14 = 1kHz, 1Vpp V15 = L, R _L = ∞		Pin 1
CONT3 Switching Speed 3A → 3B	SS 3A→3B	—	50	150	ns			Pin 1
CONT3 Switching Speed 3B → 3A	SS 3B→3A	—	50	150	ns			Pin 1



Voltage Gain vs. Frequency

T-77-07-05

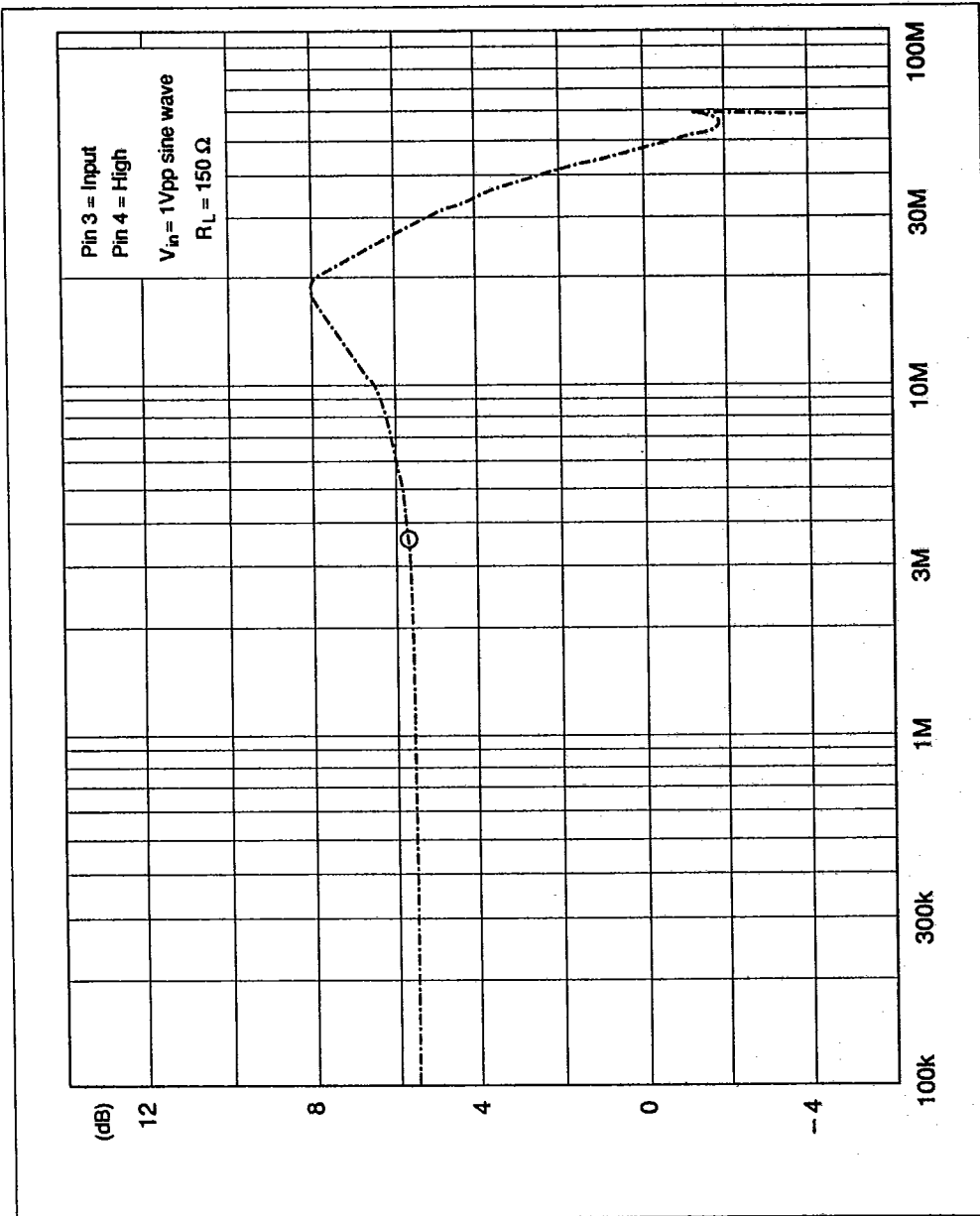

Distortion vs. Frequency

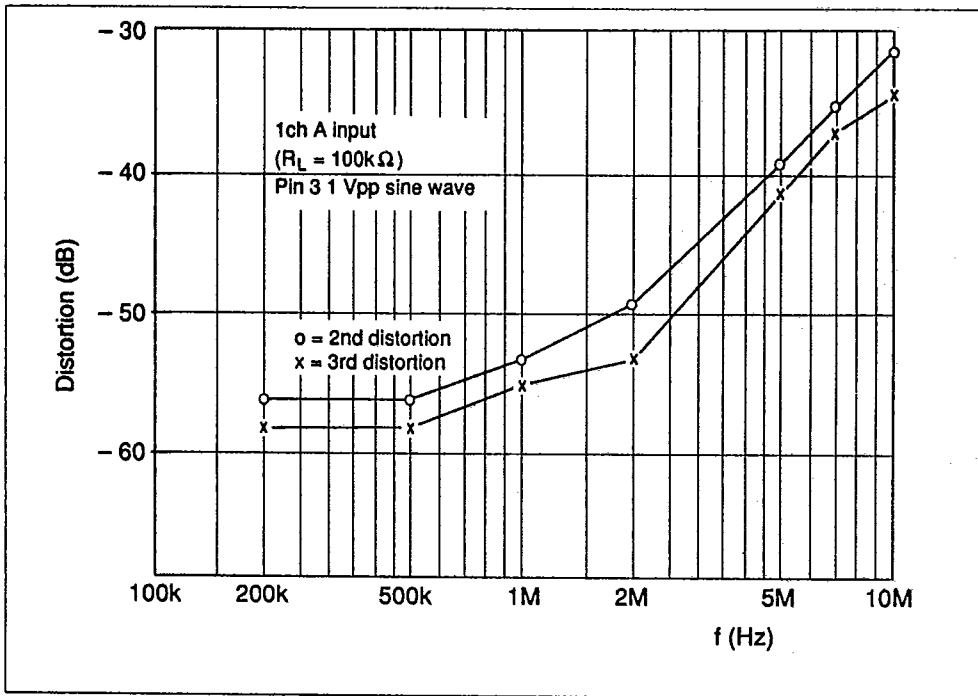

Crosstalk vs. Frequency

