

DATA SHEET

SA2400A

Single chip transceiver for
2.45 GHz ISM band

Product data

2002 Nov 04

Single chip transceiver for 2.45 GHz ISM band

SA2400A

1. DESCRIPTION

The SA2400A is a fully integrated single IC RF transceiver designed for 2.45 GHz wireless LAN (WLAN) applications. It is a direct conversion radio architecture that is fabricated on an advanced 30 GHz f_T BiCMOS process. The SA2400A combines a receiver, transmitter, and LO generation into a single IC. The receiver consists of a low-noise amplifier, down-conversion mixers, fully integrated channel filters, and an Automatic Gain Control (AGC) with an on-chip closed loop. The transmitter contains power ramping, filters, up-conversion, and pre-drivers. The LO generation is formed by an entirely on-chip VCO and a fractional-N synthesizer.

Typical system performance parameters for the receiver are 93 dB gain, 7.5 dB noise figure, input-referred third-order intercept point (IIP3) of +1 dBm, AGC settling time of 8 μ s, and Tx-to-Rx switching time of 3 μ s. The transmitter typical system performance parameters are an output power range from -7 dBm to +8 dBm in 1 dB steps, -40 dBc carrier leakage after calibration, 22 dB sideband suppression, in-band common mode rejection of 30 dB, and Rx-to-Tx switching time of 3 μ s.

2. FUNCTIONAL BLOCKS AND FEATURES

The block diagram of the SA2400A Direct Conversion transceiver is given in Figure 1. It consists of the following functional blocks:

- A 79 dB adjustable gain range direct conversion zero IF receiver with 3 μ s (typical) Tx to Rx switching time, and comprising the following:
 - Front-end LNA with two internal gain states
 - A fast on-chip closed loop composite RF and IF AGC with zoomed analog RSSI output and 8 μ s settling time
 - Quadrature downconverters from 2.45 GHz RF directly to zero IF
 - On-chip fast baseband DC cancellation with automatically stepped bandwidths of 10 MHz, 1 MHz, 100 kHz, and 10 kHz, settling within 8–13 μ s for a DC error of 10% that decays to 1%.
 - Fully integrated channel filters, appropriate for 11 Msymbols/s QPSK modulation RF bandwidth.

- An I/Q upconverter from baseband directly to 2.45 GHz, with +8 dBm output power, -40 dBc typical carrier leakage (calibrated) and 3 μ s (typical) Rx to Tx switching time, and comprising the following:
 - Wide band IQ modulator producing better than 14% EVM for 11 Msymbols/s QPSK modulation
 - Integrated reconstruction and spectral shaping filters at I and Q modulation input that is driven by an external D/A. High common mode rejection to input ground bounce.
 - FIR-DACs for digital I/Q input feeding the analog signal path and including additional filtering for spectral shaping.
 - 2.45 GHz power amplifier driver with +8 dBm maximum output, 15 dB adjustable gain in 1 dB steps and a second switched output at -1.5 dBm power level with similar gain adjustments that are set by a separate register.
 - Completely on-chip calibration for Carrier Leakage compensation.
 - Internal power ramping with 2 μ s delay and 0.5 μ s ramp-up time.
- A fractional-N frequency synthesizer with on-chip VCO and XO
- A 3-wire bus for control of most blocks
- An additional high speed 3-wire bus for full control of Rx-Gain and DC-offset compensation parameters with 44Mbits/s.
- Fast Tx-Rx switching based on a single digital input pin.
- Reference currents and voltage for supply of Baseband Processor and PA-chip.

3. APPLICATIONS

- IEEE 802.11 and 802.11b radios
 - Supports DSSS and CCK modulation
 - Supports data rates: 1, 2, 5.5, and 11 Mbps
- 2.45 GHz ISM band wireless communication devices

Table 1. Ordering Information

TYPE NUMBER	PACKAGE		
	NAME	DESCRIPTION	VERSION
SA2400ABE	LQFP48	plastic low profile quad flat package; 48 leads; body 7 x 7 x 1.4 mm	SOT313-2

Single chip transceiver for 2.45 GHz ISM band

SA2400A

4. BLOCK DIAGRAM

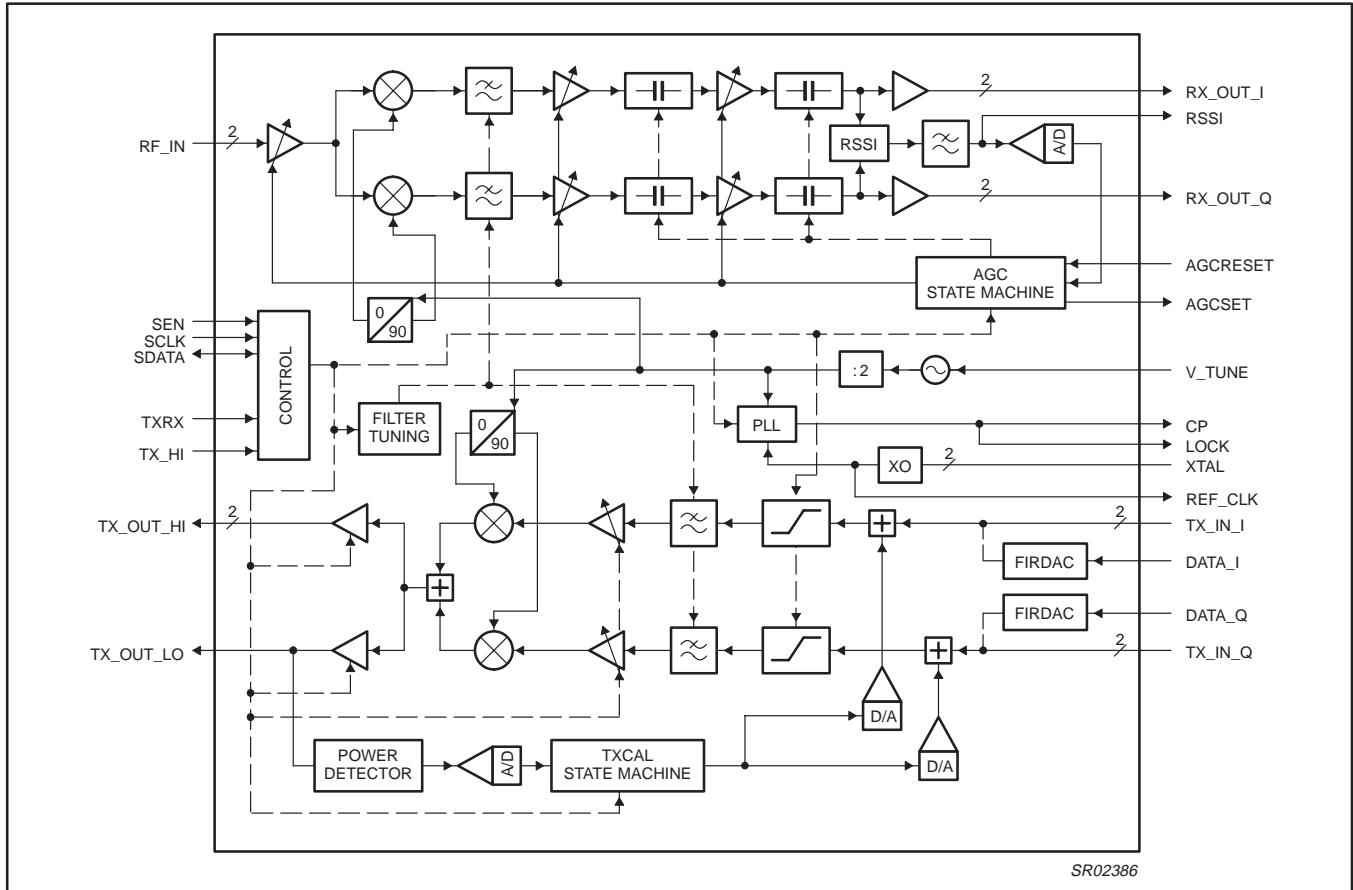

Figure 1. SA2400A functional block diagram.

Single chip transceiver for 2.45 GHz ISM band

SA2400A

5. PINNING INFORMATION

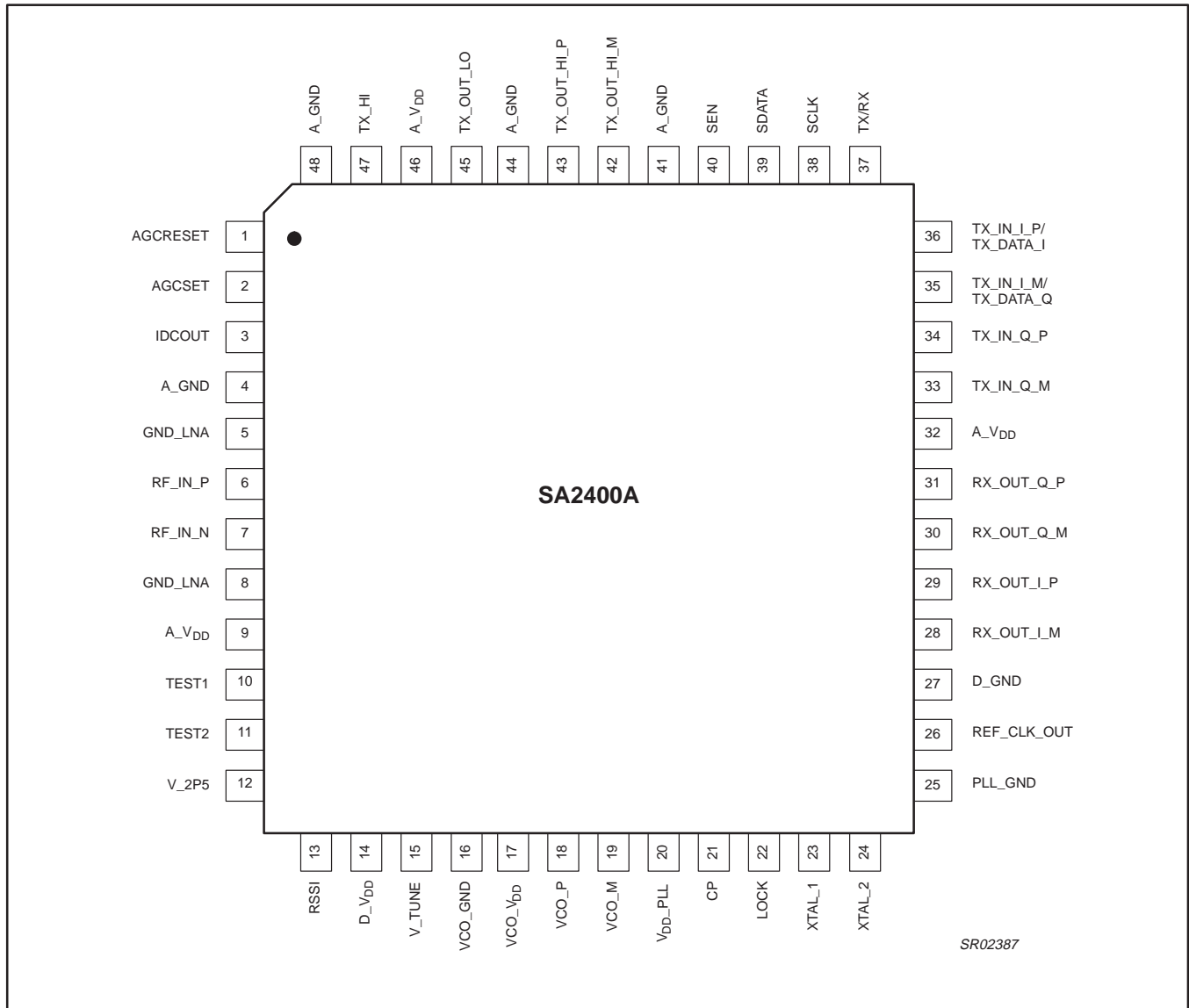

Figure 2. Pin configuration.

Single chip transceiver for 2.45 GHz ISM band

SA2400A

Table 2. Pin description

PIN type is designated by A = Analog, D = Digital, I = Input, O = Output

SYMBOL	PIN	DESCRIPTION	TYPE
AGCRESET	1	AGC start input	DI
AGCSET	2	AGC settled output	DO
IDCOUT	3	Tx-mode: DC reference current	AO
A_GND	4	Analog Ground	
GND_LNA	5	Analog Ground	
RF_IN_P	6	RF input (positive)	AI
RF_IN_N	7	RF input (negative)	AI
GND_LNA	8	Analog Ground	
A_VDD	9	Analog Supply	
TEST_1	10	Test pin	
TEST_2	11	Test pin	
V_2P5	12	DC reference voltage	AO
RSSI	13	RSSI output signal	AO
D_VDD	14	Digital Supply	
V_TUNE	15	VCO tuning voltage	AI
VCO_GND	16	VCO ground	
VCO_VDD	17	VCO Supply	
VCO_P	18	VCO output/ External VCO input	AI/O
VCO_M	19	VCO output/ External VCO input	AI/O
VDD_PLL	20	Synthesizer Supply	
CP	21	Charge pump output	AO
LOCK	22	Synthesizer lock indicator	AO
XTAL_1	23	Crystal input	AI
XTAL_2	24	Crystal input	AI

SYMBOL	PIN	DESCRIPTION	TYPE
PLL_GND	25	Synthesizer Ground	
REF_CLK_OUT	26	Reference clock output	AO
D_GND	27	Digital and Analog Ground	
RX_OUT_I_M	28	Receive output	AO
RX_OUT_I_P	29	Receive output	AO
RX_OUT_Q_M	30	Receive output	AO
RX_OUT_Q_P	31	Receive output	AO
A_VDD	32	Analog Supply	
TX_IN_Q_M	33	Transmit input	AI
TX_IN_Q_P	34	Transmit input	AI
TX_IN_I_M/ TX_DATA_Q	35	Transmit input	AI/DI
TX_IN_I_P/ TX_DATA_I	36	Transmit input	AI/DI
TX/RX	37	Tx/Rx mode select	DI
SCLK	38	Three-wire bus clock	DI
SDATA	39	Three wire bus data	DI/O
SEN	40	Three wire bus enable	DI
A_GND	41	Analog Ground	
TX_OUT_HI_M	42	Transmit output, high power	AO
TX_OUT_HI_P	43	Transmit output, high power	AO
A_GND	44	Analog Ground	
TX_OUT_LO	45	Transmit output, low power	AO
A_VDD	46	Analog Supply	
TX_HI	47	Transmit output power level select	DI
A_GND	48	Analog Ground	

Single chip transceiver for 2.45 GHz ISM band

SA2400A

6. FUNCTIONAL DESCRIPTION

The SA2400A transceiver is intended for operation in the 2.45 GHz band, specifically for IEEE 802.11b 1 and 2 Mbps/s DSSS, and 5.5 and 11 Mbps/s CCK standards. Throughout this document, the operating RF frequency refers to the ISM band between 2.4 GHz and 2.5 GHz.

6.1 RF VCO

The local oscillator is common to both the transmitter and the receiver. The RF VCO is a differential 4.8 GHz oscillator with the frequency determining components internal to the IC. The VCO is connected internally to a frequency divider and a quadrature generator circuit which produces the LO for the IQ up- and downmixer. The divider output is also internally connected to the synthesizer, which can be programmed in order to produce steps of 0.5 MHz for the desired LO frequency.

At the time of power-up, the VCO must be calibrated by invoking the VCOCALIB mode by means of the three-wire bus. This operation will select an appropriate frequency band in the VCO, thus compensating for process tolerances. The calibration takes up to 2.2 ms, after which the IC automatically enters the SLEEP mode. The synthesizer registers 0x00 through 0x03 must be re-programmed after completing the VCOCALIB.

The 2.45 GHz LO can also be injected externally.

6.2 RF Low Noise Amplifier

The RF LNA has differential inputs and an external balun is needed in the case of single-ended operation. It has two gain states which are controlled internally by the on-chip automatic gain control, or manually via the 3-wire bus.

6.3 Downconversion mixers

The RF signal is converted down directly to baseband by quadrature image-reject mixers.

6.4 Receiver low-pass filter, baseband amplifiers

The I and Q low-pass filters are fully integrated Chebychev active filters. The I and Q pass band extends from DC to a -3 dB corner at 7 MHz.

Additional adjustable gain is provided in baseband amplifiers to achieve a total adjustable gain range of 79 dB. The Rx output is provided in the form of differential I and Q signals, which must be DC coupled to the ADC inputs on a base band IC.

6.5 DC cancellation

The Rx chain also integrates a high-pass filter (DC notch) for cancellation of the DC offset inherent to zero-IF operation. The high-pass filter has a programmable lower 3 dB cutoff frequency of 10 MHz, 1 MHz, 100 kHz or 10 kHz. The DC offset cancellation occurs simultaneously with the AGC settling process. During the AGC settling phase (see below) the cutoff frequency is dynamically selected between 10 MHz and 1 MHz to quickly reduce DC offset values from +50 dBc to below -20 dBc relative to a -76 dBm antenna input signal before the RSSI (see below) is internally sampled. After the AGC settling, the high pass is configured for 100 kHz for 5 μ s before switching to a final 10 kHz cutoff frequency. The low value of 10 kHz is required for minimizing the signal distortion created by a high-pass function at zero frequency. The

high-pass will then remain set to the 10 kHz cutoff frequency until a new AGC cycle is started.

Whenever there is a frequency change in the high-pass filter lower cutoff, the DC offset can change from a very low value to about 50% (1 MHz \geq 100 kHz step) or 10% (100 kHz \geq 10 kHz step) of the signal level. This DC offset then decays according to the high-pass response of the filter.

The cutoff frequency of the high-pass filter can also be selected manually by using the RXMGC mode.

6.6 AGC

The receiver contains a fully integrated Automatic Gain Control loop. It works by adjusting the internal gain such that the Rx output amplitude, as measured by the RSSI (see below), meets a predefined target value.

By default, the AGC is always set to a default maximum gain (adjustable by register value GMAX) whenever the SA2400A enters the RECEIVE mode of operation from another operational mode. It takes 5 μ s for the receiver to settle when it enters this mode, which includes the time for DC offsets to be removed with a 1 MHz lower cut-off frequency of the high-pass filtering. This lower cut-off frequency of 1 MHz remains unchanged as long as the AGC remains in the default maximum gain state.

The AGC must be invoked by providing a 0-to-1 transition on the AGCRESET pin, and keeping the signal on that pin to 1 for at least 5 μ s.

By successively reducing the gain from its initial maximum value, the loop searches for the correct gain value to provide a nominal output amplitude of 500 mV_{peak, differential} for a QPSK signal (within ± 3 dB dynamic error) at the output pins. This is achieved after a maximum of 8 μ s. This time is defined by wait periods necessary to settle the receiver after gain switching actions. The individual wait periods can be adjusted by means of register settings.

After completing the AGC settling process, the AGCSET pin is set to 1 by the algorithm. The receiver gain then will not change again until another pulse is issued on the AGCRESET pin.

For a subsequent AGC operation, the receiver needs to enter its maximum gain state again. If another AGCRESET signal (as described above) is issued, the settling period will take an extra 3 μ s, up to a total of 11 μ s, since the first 3 μ s will be spent on entering maximum gain mode and settling the receiver thereafter. To shorten this operation, the receiver can be forced to maximum gain (e.g., at a time when no signal is present) by issuing a 0–1–0 pulse of maximum 1 μ s pulse width on the AGCRESET pin. The receiver will then enter maximum gain mode (the AGCSET signal will **not** be set to 1 after this), and a following 0-to-1 transition on the AGCRESET pin will start the settling sequence from maximum gain, which will then take a maximum of 8 μ s.

The receiver gain can also be selected manually by using the RXMGC mode.

The settling target can be adjusted by ± 7 dB from the nominal level of 500 mV_{peak, differential} by means of register settings.

Note: When doing measurements with a single-tone RF signal, the amplitude at the Rx outputs after settling the AGC will be lower, at about 300 mV_{peak, differential}.

Single chip transceiver for 2.45 GHz ISM band

SA2400A

6.7 AGC Handshake

On the digital input pin AGCRESET, a 0-to-1 transition clears AGCSET output to logic 0 and starts the AGC cycle. At the end of the AGC settling, the AGCSET output is asserted to logic 1. The AGCRESET input can then be reset to logic 0. At any time in the RECEIVE mode the AGC can be forced to the maximum gain by giving the AGCRESET signal as described, but by additionally re-setting it to logic 0 within 1 μ s. The AGCSET indication is not given in this case and the receiver settling time is 3 μ s. The channel filters will be set to have a lower cut-off of 1 MHz. For a timing diagram, please see the receiver parameters section.

6.8 RSSI

The Receive Signal Strength Indicator (RSSI) is implemented as an error signal comparing the signal level at the Rx output to the nominal value of 500 mV_{peak,differential}. It has a -10 dBc to +10 dBc operational range relative to the nominal signal level. Since the RSSI acts on the modulated RF signal envelope that is extracted from the baseband I and Q signals, it includes DC offsets, and will therefore show transient decaying errors when the AC coupling lower cut-off frequency is changed.

The RSSI signal reflects on a logarithmic scale the amplitude of the instantaneous modulated RF signal (envelope). The RSSI signal is filtered by a low-pass filter with 0.5 MHz upper cut-off frequency.

The SA2400A receiver is designed to give at least -10 dBc RSSI at maximum gain, when there is no signal present, i.e., with only thermal noise. However, due to process spreads (e.g., gain, noise figure, IQ low-pass filter bandwidth, etc.), the RSSI may show higher than -10 dBc. In case a calibration is required for setting this noise power to -10 dBc, the AGC's maximum gain (GMAX) can be changed in the range of 85 to 54 dB in steps of 1 dB via register settings. The programmed value of maximum gain is never altered by the AGC settling or by forcing the AGC to maximum gain. Only the RXMGC mode can set the AGC gain to values higher than GMAX. The RXMGC mode does not change the value of GMAX.

6.9 Receiver blocking immunity

The receiver is designed to exceed the IEEE802.11 specifications for the blocking and intermodulation. It can accept continuous or randomly pulsed interfering single- or multi-tone signals that are more than 35 dB stronger than the wanted signal, and up to -10 dBm of interference level. The spurious I and Q outputs are maintained to smaller than -20 dBc of the wanted signal level.

6.10 Transmitter and IQ upconverter

The transmitter inputs are designed to be driven from a Baseband IC in one of two modes: a) in analog mode, differential I and Q inputs expect current signals driven by DACs in the Baseband IC; or b) in digital mode, single-ended inputs expect two binary data

streams. In this case, integrated FIR-DACS provide additional filtering. The data streams are sampled with the reference clock. For timing specifications, please see the transmitter parameters section.

The wide band IQ upconverter includes spectral shaping reconstruction filters (4th order low-pass Butterworth with 9.75 MHz 3 dB upper cut-off frequency).

At +8 dBm maximum transmitter output level the out-of-band (FCC forbidden band) spurious signal power is less than -77 dBc (integrated over 1 MHz with a 100 kHz resolution bandwidth) for the 11 Msymbols/sec CCK modulation (footnote ¹). This implies that the spectral regrowth is dominated by any external PA that may be used to boost the transmission power level.

In analog mode, it is assumed that the input baseband IQ signals as delivered from the Baseband IC are pulse shaped.

By using the on-chip calibration loop, the transmitter Carrier Leakage can be reduced to levels far less than required by the standard. An RF power meter detects the LO level, converts it into a digital signal and a state machine determines the compensation values which are fed through a DAC directly to the IQ inputs. This mode is activated by setting the IC into the DCALIB mode by means of 3-wire bus programming. This calibration is designed to compensate for any DC offsets delivered by the ADCs on the Baseband IC. The DCALIB cannot be used when the IC is using the digital-input Tx mode.

The IQ gain and phase imbalance, reconstruction filter roll-off and in-channel noise produce a modulation EVM of less than 12% for 11 Msymbols/sec QPSK. The transmitter has two switched outputs, one with -1.5 dBm output power and the other one with +8 dBm output power. The input pin TX_HI is used to select between the two RF output ports.

The 8 dBm output port is differential and is designed to work seamlessly (no external filtering required) with the SA2411 power amplifier.

Upon entering the Tx mode, the ramping up of the RF Tx signal is delayed by an internal power ramping circuit. The ramping up time is fixed, while the delay prior to ramping up can be programmed by register settings.

Note: When switching out of the Transmit mode (either into Receive mode by transition on TXRX pin, or into another mode by 3-wire programming), the reference clock input (pins XTAL_1 and XTAL_2) needs to be active since a digital timer is being used.

6.11 Reference current and voltage outputs

The IC provides a temperature-constant reference current of 1 mA or 300 μ A (selectable), active in Tx mode, as well as a 2.5 V reference voltage.

1. For a CCK signal, the peak signal power is 21.7 dB lower than the total power integrated over the 22 MHz band. The SA2400A guarantees better than 56 dBc suppression of the second sidelobe (greater than 22 MHz frequency offset). Consequently, the power level in the forbidden bands is at least 77 dBc below the transmitted integrated power.

Single chip transceiver for 2.45 GHz ISM band

SA2400A

7. OPERATING CONDITIONS

Table 3. Absolute Maximum Ratings

Symbol	Parameter	Min	Max	Unit
T _{stg}	Storage temperature	-55	+150	°C
V _{DD}	Supply voltage	-0.5	+3.85	V
	Voltage applied to inputs	-0.5	V _{DD} +0.5	V
	Short circuit duration, to GND or V _{DD}	-	1	second

Table 4. Recommended Operating Conditions

Symbol	Parameter	Min	Nom	Max	Units
T _{amb}	Ambient operating temperature (Note 1)	-30	-	+85	°C
V _{DD}	Supply voltage	2.85	3.3	3.6	V

NOTE:

- When the digital input mode is used, the lower limit of the ambient operating temperature is higher than -30 °C. Preliminary characterization results suggest a limit of -20 °C. This does not apply if the analog input mode is used.

8. OPERATIONAL MODES AND CURRENT CONSUMPTION

(See also Table 18).

Table 5. Operational modes and current consumption

T_{amb} = 25 °C; V_{CC} = 3.3 V.

Chip state	Main mode (register 0x04)	Other conditions	Description	Duration (max.)	Current (mA)		
					Min	Typ	Max
POWER-UP	SLEEP	XO on, clock output on		n/a	1.8	2.2	2.7
SLEEP	SLEEP	XO off	Note 1.	n/a	-	-	0.05
TX HI	TX/RX or FASTTXRXMGC	TXRX = HIGH; TX_HI = HIGH	Synthesizer ON. Transmitter ON with 8 dBm driver. Maximum gain.	n/a	120	143	170
TX LO	TX/RX or FASTTXRXMGC	TXRX = HIGH; TX_HI = LOW	Synthesizer ON. Transmitter ON with -1.5 dBm driver. Maximum gain.	n/a	81	95	105
RX	TX/RX or RXMGC or FASTTXRXMGC	TXRX = LOW	Synthesizer ON. Receiver ON. Receiver gain control by: <ul style="list-style-type: none"> • TX/RX ⇒ internal AGC • RXMGC ⇒ 3-wire bus programming • FASTTXRXMGC ⇒ fast 3-wire bus 	n/a	81	95	105
WAIT	WAIT		Only Synthesizer and Xtal oscillator ON	n/a	27	31	34
FCALIB	FCALIB		Calibrates cut-off frequency of Tx and Rx filters internally. Automatic transition to SLEEP mode upon completion.	3 μs	-	n/a	-
DCALIB	DCALIB	Maintain TX mode for 5 μs before calibration. Quiescent IQ input. Analog mode used.	Calibration to reduce transmitter carrier leakage. Automatic transition to SLEEP mode upon completion.	20 μs	-	n/a	-
VCOALIB	VCOALIB		Calibrates internal VCO.	2200 μs	-	n/a	-
RESET	RESET		Resets IC into power-up state (SLEEP mode and all registers at default values)	n/a	-	n/a	-

NOTE:

- All digital inputs connected to GND or V_{DD}.

Single chip transceiver for 2.45 GHz ISM band

SA2400A

8.1 RESET

Shuts down all blocks except the 3-wire digital section, and programs internal registers to known default values that are described in section 13. This ensures that the SA2400A transmitter, receiver, synthesizer and other blocks enter a known state when made active. The SA2400A enters the SLEEP state automatically after the RESET state. Before entering either the TXRX or RXMGC active states, the internal registers can be reprogrammed to change their values from the default values. A power-up of the digital supply also forces the SA2400A to the RESET mode.

8.2 SLEEP

All blocks (except the xtal osc) are OFF. The xtal osc can be separately shut down. Note that the 3-wire bus will remain operational in all modes as long as the digital supply is ON. The SA2400A retains programmed values of all active modes when it comes out of the sleep mode. This includes the synthesizer operation. Programmed via 3-wire bus.

8.3 WAIT

The PLL is on. Receiver and the transmitter are both OFF. This mode is useful for a quick turn-around to either TXRX or RXMGC modes. Transition to or from this mode is done via the 3-wire bus.

8.4 RXMGC

Only the PLL and Receiver are operating. The AGC gain is manually set by the value of a register field.

8.5 TXRX

In this mode the logic level on the TX/RX input pin determines the operational mode: 1 = TRANSMIT, 0 = RECEIVE. This way, no 3-wire bus programming is necessary to switch between Tx and Rx, resulting in faster switching. When entering the RECEIVE mode (either via 3-wire programming to TXRX mode with TX/RX pin at logic zero, or by a 1-to-0 transition of TX/RX pin when already in the TXRX mode), the Receiver is set to maximum gain. An AGC cycle is

initiated by a 0-to-1 change on the AGC_RESET digital input pin. At any time in the RECEIVE mode, the AGC can be forced to the maximum gain setting by giving a 1 μ s pulse on the AGC_RESET input while the TX/RX input is held at logic 0.

8.6 FASTTXRXMGC

It is similar to the RXMGC mode, except that the manual AGC gain programming can be done faster, as described in Section 14.5.

8.7 FCALIB

This mode needs to be programmed after power ON in order to internally calibrate the cut-off frequency of the on-chip transmit and receive active filters. Upon completion of the calibration, the IC will automatically switch to Main Mode = SLEEP. This calibration takes a maximum of 3 μ s measured from the end of the programming sequence. The result of this calibration can be read out from register word 0x04.

8.8 DCALIB

If the analog Tx inputs are used, this mode needs to be programmed at least once after power ON in order to reduce the transmitter carrier leakage. This mode should be programmed after being in TX mode for at least 5 μ s. Upon completion of the calibration, the IC will automatically switch to Main Mode = SLEEP. This calibration takes a maximum of 20 μ s measured from the end of the programming sequence. The result of this calibration can be read out from register 0x07.

8.9 VCOCALIB

This mode needs to be programmed at least once after power ON in order to calibrate the internal VCO. Upon completion of the calibration, the IC will automatically switch to Main Mode = SLEEP. This calibration takes a maximum of 2.2 ms from the end of the programming sequence. After this calibration, the synthesizer must be re-programmed by writing the register words 0x00 through 0x03. The result of this calibration can be read out from register 0x08.

Single chip transceiver for 2.45 GHz ISM band

SA2400A

9. SA2400A RECEIVER

The baseband output signal extends from DC to 8 MHz, and the out-of-band frequency begins from 11 MHz. The modulated test signal used is 11 Msymbols/sec QPSK with raised cosine filtering (50% excess bandwidth for 11 Msymbols/sec). The LO frequency is the same as the Receiver channel center frequency, as the IF output is at 0 Hz.

Table 6. SA2400A Receiver properties

$T_{amb} = 25\text{ }^{\circ}\text{C}$; $V_{CC} = 3.3\text{ V}$; $f_{LO} = 2.45\text{ GHz}$.

Specification	Conditions	Min	Typ	Max	Units
RF input frequency range	Typical	2.4		2.5	GHz
S11 (RF input)	Incl balun+matching. 50 Ω unbalanced. Note 3. LNA in high gain (see reg. description 0x06) LNA in low gain		-10 -7	- -	dB dB
Maximum Rx voltage gain	RF input to I or Q outputs	90	93	-	dB
Max RF input level	Including application, AGCTARGET = +5. Note 1.	-10	-	-	dBm
	To maintain nominal IQ output levels as defined below ("nominal I and Q output voltage")	-20	-	-	dBm
IQ Output DC error (relative to signal, 5 μ s after AGC set)	-80 dBm < P_{input} < -20 dBm, 1 MHz sinewave output. Note 3.	-	-	-20	dBc
AGC settling time (indicated by AGC_SET digital output)	Initiated by AGC_RESET input. Constant RF input within this settling time. Begins after TX to RX switching time. Measured from AGC_RESET 0-1 transition. AGC delay registers (0x05) at default or smaller values. Note 2. a) First instance b) 2 nd or subsequent instances	-	-	8	μ s
		-	-	11	μ s
AGC Max Gain settling time	AGC forced to GMAX by: a) TX to RX mode transition. (measured after 5 μ s TX-RX settling time). b) Pulse on AGC_RESET pin (measured from end of programming) Note 2.	-	-	0	μ s
		-	-	3	μ s
AGC Max Gain adjustment range	Note 2.	54 to 85, in steps of 1			dB
AGC error (I, Q signal levels)	RF input between -75 to -20 dBm. AGC_RESET used. AGC delay registers (0x05) at default values. a) Random (varies each AGC cycle)	-3	-	3	dB
	b) Slow (varies with V_{CC} , Temperature).	-1	-	1	dB
	c) Static (fixed, part to part)	-1	-	1	dB
DC cancellation time (after AGCRESET)	With constant RF input during this time. Note 3. a) DC offset < 50% of output signal level b) DC offset < 10% of output signal level	-	-	8	μ s
		-	-	13	μ s
TX to RX switching time	Output signal within 1 dB of final value, frequency error within 25 ppm of final value. Note 3.	-	3	3.5	μ s
Noise Figure (Incl balun+matching)	Less than the piece-wise linear interpolation. Note 3. $P_{input} = -85\text{ dBm}$ (LNA in high gain mode)	-	7.5	9	dB
	-75 dBm	-	7.5	9	dB
	-60 dBm (LNA in low gain mode)	-	24	25	dB
	-45 dBm	-	24	25	dB
Input IP3 (50 Ω source resistance)	2 interfering tones of power $P_{interferer}$ each, at 13 and 23 MHz offsets from LO. IP3 to be more than the piece-wise linear interpolation: $P_{interferer} = -39\text{ dBm}$	-5	1	-	dBm
1 dB compression of wanted signal	Including matching, receiver at minimum gain.	-10	0	-	dBm
Desens by jammer	-45 dBm wanted signal at 1 MHz offset, +40 dBc jammer at 25 MHz offset. Note 3.	-	-	1	dB

Single chip transceiver for 2.45 GHz ISM band

SA2400A

Specification	Conditions	Min	Typ	Max	Units
LO leakage to antenna	All gain modes. Incl balun	–	–75	–57	dBm
Residual sideband Rejection	Measured with single tone at 2 MHz offset from carrier. Includes both IQ gain and phase error. Notes 3, 7.	22	29	–	dB
Ripple band width of filter	Note 4.	5.6	6.3	7.0	MHz
3 dB band width of filter	Indicative, not tested. Note 4.	–	7	–	MHz
In-band amplitude ripple	DC to ripple band width edge. Note 3.	–	–	0.6	dB peak
Out-of-band attenuation	Relative to minimum in-band gain > 11 MHz > 22 MHz	25 55	– –	– –	dB dB
Lower 3 dB cut-off frequency of AC coupling	Cascade of two 1st order high-pass filters. a) NARROW BAND b) INTERMEDIATE BAND c) WIDE BAND	– – –	10 100 1000	– – –	kHz kHz kHz
Output load resistance	Pin to GND, differential. Note 5.	15	–	–	k Ω
Output load capacitance	Pin to GND	–	–	6	pF
Nominal I & Q output voltage	Differential at the load specified. Note 6.	–	0.5	–	V peak
Maximum I & Q output voltage	Saturated, differential	–	–	1.5	V peak
Common mode IQ voltage	Programmable (see 0x04) Mode 1 Mode 2	$V_{CC}/2-0.25$ 1.0	$V_{CC}/2$ 1.25	$V_{CC}/2+0.25$ 1.5	V V
1 dB compression level at output	1 MHz tone, differential. Maximum gain.	1	–	–	V peak
Total Harmonic Distortion (measured at max and min gains)	Input 1 – 5 MHz signal, 1 V peak differential sinusoidal at output, output spurs measured differential up to 100 MHz. Ratio of rms total spurious distortion to rms fundamental. Receiver in minimum gain. Note 3.	–	2	4	%
	Receiver in maximum gain. Note 3.	–	5	10	%
Phase Imbalance	Signal tone input at 2 MHz offset from carrier. Indicative, not tested.	–	4	–	deg
I, /I to Q, /Q amplitude imbalance	ratio of signal at I pin to /I pin; Same for Q and /Q pins.	–	0.1	–	dB
RSSI voltage in settled state (internal AGC)	Corresponds to I, Q output signal levels when AGC_RESET is used, with RF input between –10 and –80 dBm. 1 MHz tone, 0.5 V peak differential. AGCTARGET = 0	1.25	1.55	1.95	V
RSSI voltage difference	1 dB change in input power compared to settled state	–	64.5	–	mV
RSSI minimum voltage	Signal power = –10 dBc	–	0.9	–	V
RSSI maximum output voltage	Signal power = +10 dBc	–	2.2	–	V
RSSI error	–10 dBc < signal power < +10 dBc	–	± 1	–	dB

NOTES:

- Corresponds to –15 dBm input level at IC input, assuming typical 5 dB loss from the antenna to the IC input. The AGCTARGET register should be set to “+5” which causes the AGC to settle to an output amplitude greater than the specified nominal value. A resistive divider network at the output can be used to adjust the actual IQ output levels to the BB ADC range.
- Guaranteed by design.
- Verified by bench characterization and found to have sufficient margin for production.
- At power-up time, the filter bandwidth is undefined. It needs to be calibrated with the internal tuner (FCALIB mode).
- For unsymmetrical loading, attach the same load impedance to the unused pin; condition: for 80% of nominal output voltage swing.
- Nominal I/Q output levels are understood as the levels the SA2400A will settle to after an AGCRESET action is performed with an RF input signal modulated by a Barker sequence, and with AGCTARGET = 0.
- $RSB = 20 \cdot \log(\sqrt{(1+K^2 + 2K\cos\phi)/(1+K^2 - 2K\cos\phi)})$, where K = linear gain imbalance, and ϕ = phase imbalance.

Single chip transceiver for 2.45 GHz ISM band

SA2400A

9.1 AGC handshake and timing

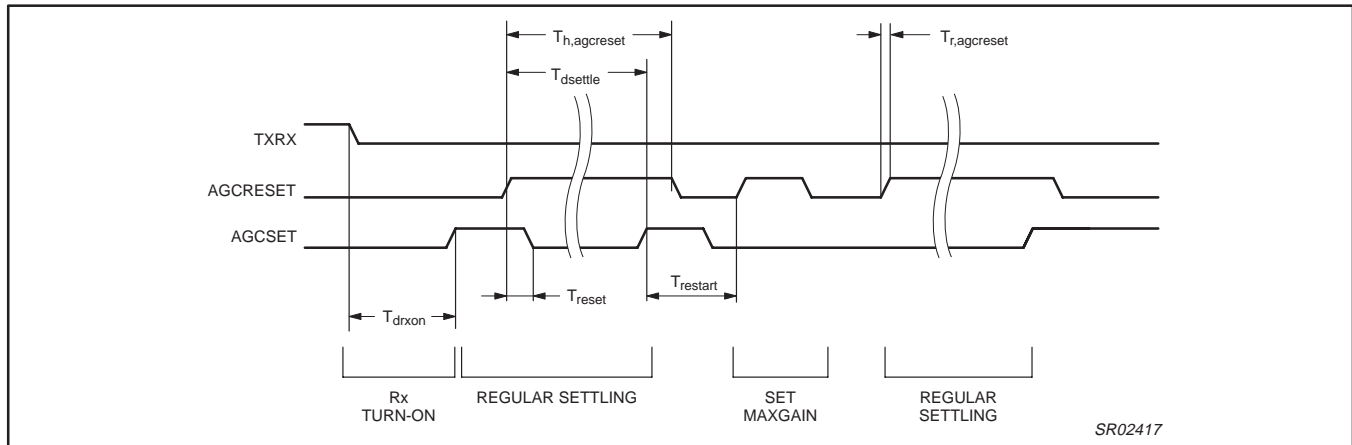

Figure 3. AGC handshake and timing.

Table 7. AGC timing

Symbol	Parameter	Condition	Min	Typ	Max	Units
AGC logic level requirements						
V _{IH}	HIGH-level logic input voltage		0.5×V _{DD}	–	V _{DD} +0.3	V
V _{IL}	LOW-level logic input voltage		–0.3	–	0.2×V _{DD}	V
AGCRESET timing						
T _{r,agcreset}	Input rise time		–	10	40	ns
T _{h,agcreset}	Input hold time	To execute AGC settling	5	8	–	μs
		To set AGC to max. Gain	–	0.5	1	μs
T _{restart}	Time between AGC cycles (Note 1)		1	–	–	μs
AGCSET timing						
T _{drxon}	Settling time after switching to Rx		–	–	5	μs
T _{reset}	Clearing time after AGCRESET		–	–	180	ns
T _{dsettle}	AGC settling time		–	–	11	μs

NOTES:

1. In certain time interval further AGCRESET rising edges will not be detected. This applies for 4.3 μs < T_{restart} < 4.8 μs.

Single chip transceiver for 2.45 GHz ISM band

SA2400A

10. SA2400A TRANSMITTER

The IQ baseband input signal used is 11 Msymbols/sec QPSK with pulse shaping and 44 MHz D/A sampling rate. The source EVM is less than 3%. The LO frequency is the same as the Transmitter channel center frequency, as the transmit IF input is at 0 Hz.

Table 8. SA2400A Transmitter properties

$T_{amb} = 25\text{ }^{\circ}\text{C}$; $V_{CC} = 3.3\text{ V}$.

Specification	Conditions	Min	Typ	Max	Units	
RF output frequency	Typical	2.4	–	2.5	GHz	
RF output power incl balun, for a CCK modulated signal	Output1, maximum	4.5	8.0	–	dBm	
	Output2, maximum	–5	–1.5	–	dBm	
Gain step size	Output1 and Output2	–	1	–	dB	
# gain steps	Output1 and Output2	–	15	–		
Spectral Mask (Output1) Note 1.	–11 to + 11 MHz, 100 kHz band	–	–	0	dBc	
	–22 to –11 and 11 to 22 MHz, 100 kHz band	–	–40	–36	dBc	
	< –22, > 22 MHz, 100 kHz band	–	–60	–56	dBc	
Spectral Mask (Output2) Note 1.	–11 to + 11 MHz, 100 kHz band	–	–	0	dBc	
	–22 to –11 and 11 to 22 MHz, 100 kHz band	–	–	–30	dBc	
	< –22, > 22 MHz, 100 kHz band	–	–	–50	dBc	
Power ramping up time	10% to 90% ramp up. Note 2.	–	0.5	–	μs	
Power ramping up delay (Note 3)	From programming to TRANSMIT mode (TXRX mode, or 0-to-1 change of TX/RX pin). Note 2.	–	2	–	μs	
Power ramping down	Note 2.					
	a) 90% to 10% ramp down b) 10% to carrier leakage level	– –	0.5 0.5	– –	μs μs	
Carrier Leakage	Analog input mode selected. No signal input, only quiescent current.					
	a) Uncalibrated	–	–	–25	dBc	
	b) Calibrated	–	–40	–30	dBc	
	Digital input mode selected.	–	–40	–28	dBc	
Carrier Leakage Adjustment	Adjustment range of input current offset	–10	–	+10	μA	
Residual Sideband Rejection	Includes both IQ phase and gain imbalance	22	–	–	dB	
Error Vector Magnitude	11 Msymbols/s QPSK. Both RF outputs. Measured with maximum gain. Note 2.	–	12	14	%	
RX to TX switching time	Note 2.					
	a) Output power within 1 dB of final value. Includes 2.5 μs for power-up delay and ramping. b) Frequency step settles to within 25 ppm of final value	– –	3 3	3.5 3.5	μs μs	
IQ filter bandwidth	Upper 3 dB cut off frequency, after calibration. Note 2.	9.25	9.75	10.25	MHz	
In-band IQ Common Mode Rejection Ratio	1–6 MHz common mode signal at –30 dBc relative to IQ differential signal. Measured at upconverted transmitter output. Note 2.	30	–	–	dB	
Out-of-band IQ Common Mode Rejection Ratio	22–100 MHz common mode signal at –10 dBc relative to IQ differential signal. Measured at upconverted transmitter output relative to in-band 1 MHz tone. Note 2.	40	–	–	dB	
IQ input signal current range	Into each arm of differential inputs that sink current to ground. Analog input selected. Note 4.	50	–	550	μA	
IQ input quiescent current	Into each arm of differential inputs that sink current to ground. Analog input selected.	–	300	–	μA	
Resulting I/Q bias voltage	With 300 μA quiescent current into each arm of differential inputs. Analog input selected.	0.6	0.7	0.8	V	
IQ AC input impedance	Analog input selected.	–	320	–	Ω	
IQ input voltage	Digital input selected	Logic LOW	–	–	$0.2V_{DD}$	V
		Logic HIGH	$0.8V_{DD}$	–	–	V

Single chip transceiver for 2.45 GHz ISM band

SA2400A

Specification	Conditions	Min	Typ	Max	Units	
IQ input timing	Digital input selected, sampling on falling edge, relative to REF_CLK_OUT	Set-up time	–	4	–	ns
		Hold time	–	4	–	ns

NOTES:

1. The 44 MHz common mode digital ground bounce on the I and Q inputs is assumed to be less than –30 dBc relative to signal level.
2. Verified by bench characterization and found to have sufficient margin for production.
3. The power ramping-up delay can be programmed to 2, 3, 4, 5 μ s. See the 3-wire bus control register map. The default is 2 μ s.
4. The differential input signal current is the difference between the I and /I (Q and /Q) instantaneous currents. The peak differential current is therefore $(I_{max}-I_{min})/2 = 500 \mu$ A.

11. VCO AND SYNTHESIZER

Table 9 lists the synthesizer specifications. The synthesizer has the same specification as the SA8027 fractional PLL main loop without the PHI speed-up mode. The phase comparator frequency used is typically 4 MHz (in fractional mode). The charge pump current is internally programmed using the 3-wire bus (Synthesizer Register C). The recommended charge pump current is 480 μ A. An external reference input of 44 MHz or 22 MHz is supported.

Table 9. Synthesizer and VCO Specifications

$T_{amb} = 25 \text{ }^\circ\text{C}$; $V_{CC} = +3 \text{ V}$

PARAMETER	TEST CONDITIONS	LIMITS			UNITS
		Min	Typ	Max	
VCO					
VCO output frequency range		2.4	–	2.5	GHz
VCO gain (K_{VCO})	$V_{tune} = 1.2 \text{ V}$	70	85	100	MHz/V
Open Loop VCO Phase Noise	Note 1. $1/f^2$ roll off region; 0.5 MHz offset	–	–113	–107	dBc/Hz
External VCO input levels	Differential; when device configured for external VCO	–10	–	0	dBm
Main divider					
N divider range		512	–	65535	
Reference divider					
Fixed reference input (XTAL_1 and XTAL_2) frequency		–	22	–	MHz
		–	44	–	MHz
R divider range (non-fractional)	SM = '000'	4	–	1023	
Reference input level	XTAL_1 input	350	–	1300	mV _{pp}
Input parallel resistance (XTAL_1, XTAL_2)	$f = 44 \text{ MHz}$; indicative, not tested	10	–	–	k Ω
Input parallel capacitance (XTAL_1, XTAL_2)	$f = 44 \text{ MHz}$; indicative, not tested	–	–	1.5	pF
Phase detector					
Phase detector frequency		–	–	4.0	MHz
Charge pump					
Charge pump current accuracy	$V_{cp} = 0.5 V_{CC}$	–20	–	+20	%
Charge pump compliance voltage		0.6	–	$V_{DD} - 0.7$	V
Output current variation vs. V_{cp} (Note 2)	V_{cp} in compliance range	–5	–	+5	%
Charge pump sink to source current Matching	$V_{cp} = 0.5 V_{CC}$	–10	–	+10	%
Charge pump "off" current leakage	$V_{cp} = 0.5 V_{CC}$	–5	± 1	5	nA

NOTES:

1. This is measured at the Output1 RF port with the SA2400A in transmit mode, with static DC offset signals to the transmitter I and Q inputs. The phase detector and divide-by-N phase noise is such that when configured as a phase locked loop with a 30 kHz loop band width, the phase noise at frequencies between 1 kHz and 30 kHz will be no worse than –80 dBc/Hz. The total closed loop spur power within a 22 MHz band around the carrier is less than –30 dBc.
2. The relative output current variation is defined as:
$$\frac{\Delta I_{ZOUT}}{I_{OUT}} = 2 \times \frac{(I_2 - I_1)}{|I_2 + I_1|}$$
 with I_1 @ $V_1 = 0.6 \text{ V}$, I_2 @ $V_2 = V_{CC} - 0.7 \text{ V}$ (see Figure 4).

Single chip transceiver for 2.45 GHz ISM band

SA2400A

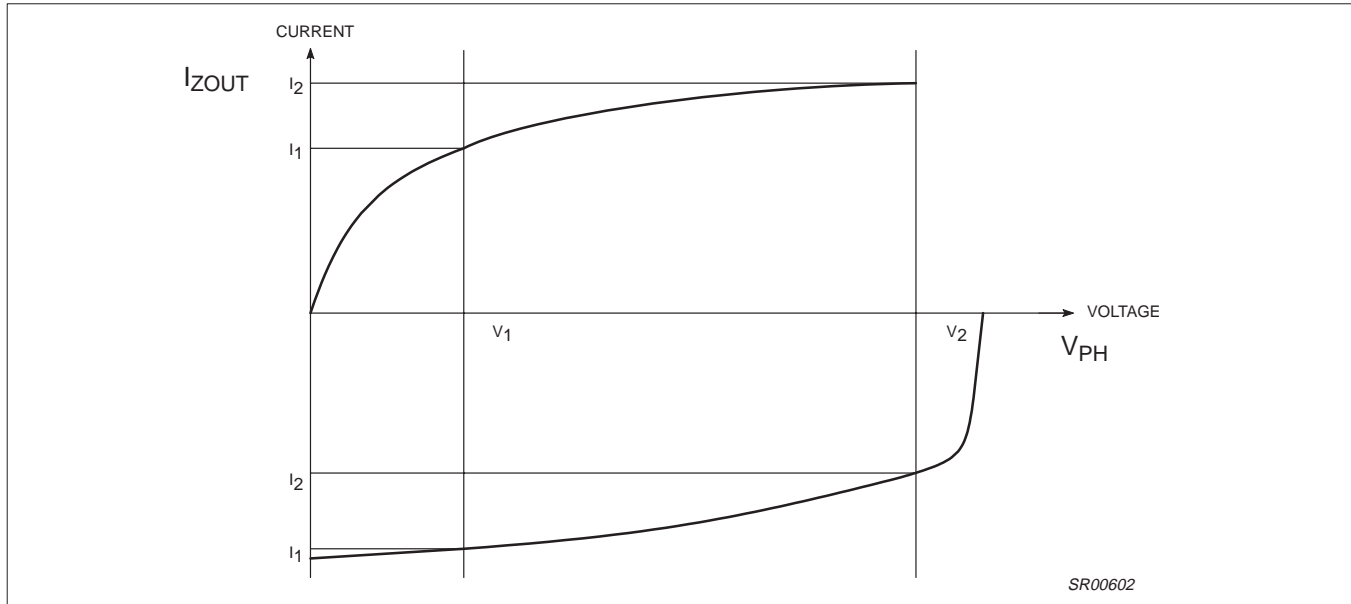

Figure 4.

12. FUNCTIONAL DESCRIPTION

12.1 Main Fractional-N divider

The divider consists of a fully programmable bipolar prescaler followed by a CMOS counter. Total divide ratios range from 512 to 65535.

At the completion of a main divider cycle, a main divider output pulse is generated which will drive the main phase comparator. Also, the fractional accumulator is incremented by the value of NF. The accumulator works with modulo Q set by FM (Synthesizer Register A). When the accumulator overflows, the overall division ratio N will be increased by 1 to N + 1, the average division ratio over Q main divider cycles (either 5 or 8) will be

$$N_{frac} = N + \frac{NF}{Q}$$

The output of the main divider will be modulated with a fractional phase ripple. The phase ripple is proportional to the contents of the fractional accumulator and is nulled by the fractional compensation charge pump.

The reloading of a new main divider ratio is synchronized to the state of the main divider to avoid introducing a phase disturbance.

12.2 Reference divider

The reference divider consists of a divider with programmable values between 4 and 1023 followed by a 3-bit binary counter. The 3-bit SM register (see Figure 5) determines which of the five output pulses are selected as the main phase detector input.

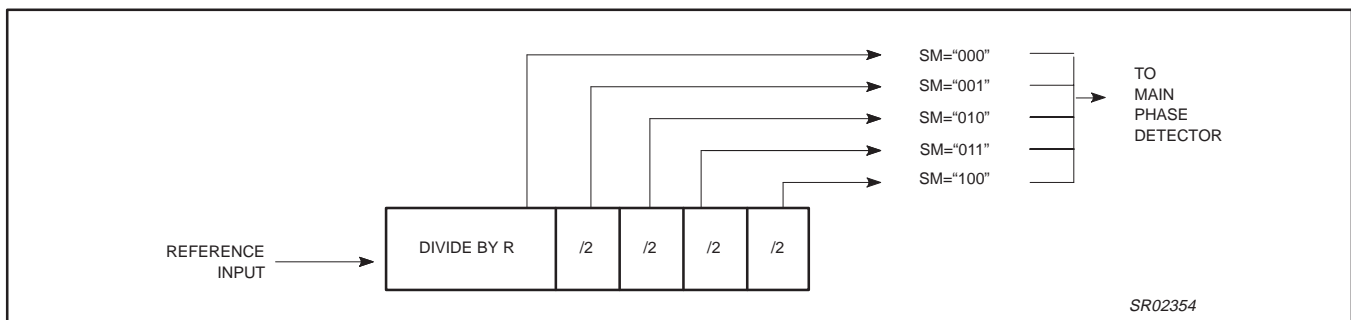

Figure 5. Reference Divider

Single chip transceiver for 2.45 GHz ISM band

SA2400A

12.3 Phase detector (see Figure 6)

The reference and main divider outputs are connected to a phase/frequency detector that controls the charge pump. The pump current is set by the control bit CP (Synthesizer Register C). The

dead zone (caused by finite time taken to switch the current sources on or off) is cancelled by forcing the pumps ON for a minimum time (τ) at every cycle (backlash time) providing improved linearity.

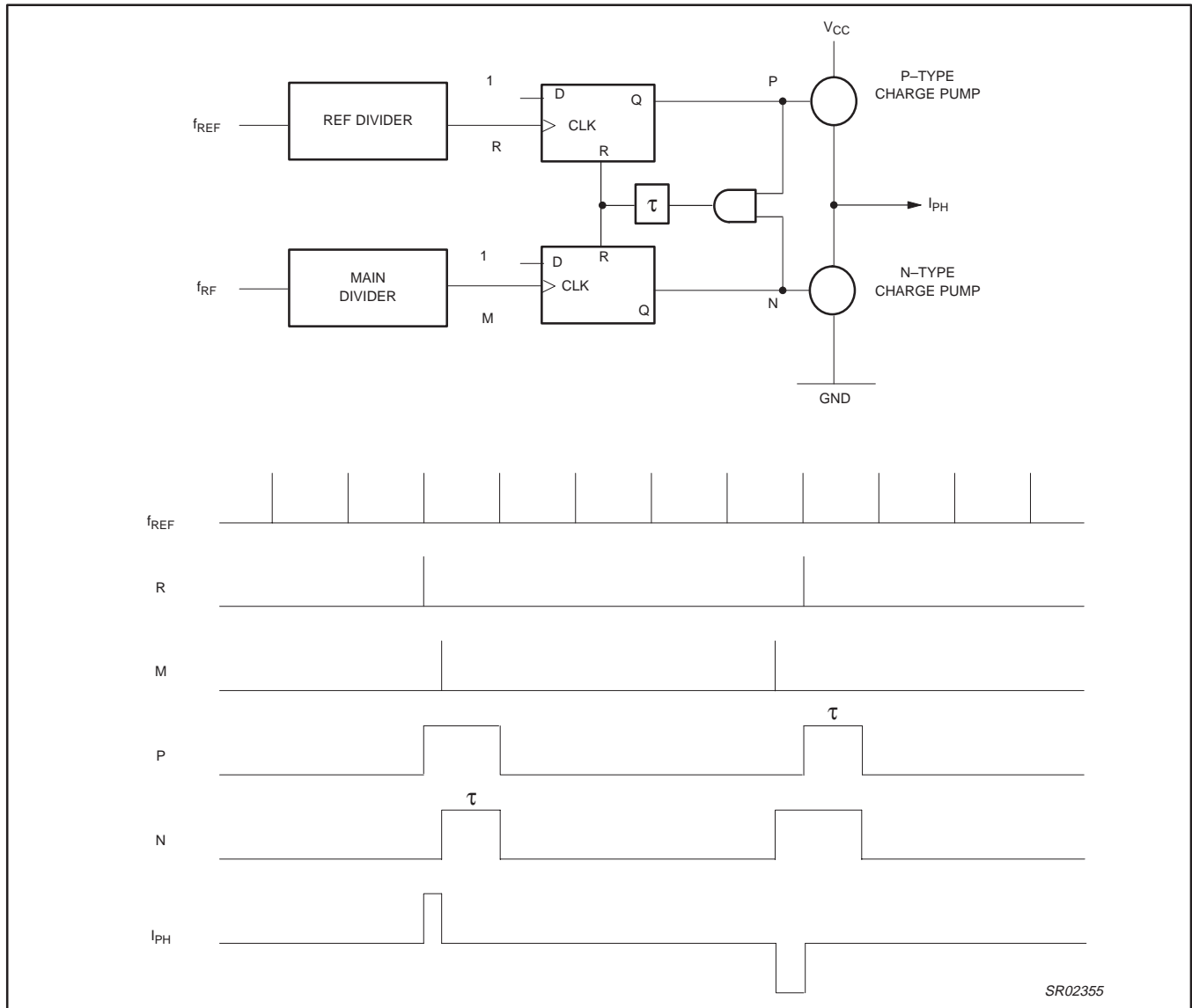

Figure 6. Phase Detector Structure with Timing

Single chip transceiver for 2.45 GHz ISM band

SA2400A

12.4 Main output charge pumps and fractional compensation currents (see Figure 7)

The main charge pumps on pin CP are driven by the main phase detector and the charge pump current value is determined by bit CP (Synthesizer Register C). The fractional compensation is derived from the contents of the fractional accumulator FRD and by the program value of the FDAC. The timing for the fractional compensation is derived from the main divider. The charge pumps will enter speed-up mode after sending a Synthesizer Register A word and stays active until a different word is sent.

12.5 Principle of fractional compensation

The fractional compensation is designed into the circuit as a means of reducing or eliminating fractional spurs that are caused by the fractional phase ripple of the main divider. If I_{COMP} is the compensation current and I_{PUMP} is the pump current:

$$I_{PUMP_TOTAL} = I_{PUMP} + I_{COMP}$$

The compensation is done by sourcing a small current, I_{COMP} , see Figure 8, that is proportional to the fractional error phase. For proper fractional compensation, the area of the fractional compensation current pulse must be equal to the area of the fractional charge pump ripple. The width of the fractional compensation pulse is fixed to 128 VCO cycles, the amplitude is proportional to the fractional

accumulator value and is adjusted by FDAC values (bits FC7–0 in Synthesizer B). The fractional compensation current is derived from the main charge pump in that it follows all the current scaling through programming or speed-up operation. For a given charge pump,

$$I_{COMP} = (I_{PUMP} / 128) * (FDAC / 5 * 128) * FRD$$

FRD is the fractional accumulator value.

The target values for FDAC are: 128 for FM = 1 (modulo 5) and 80 for FM = 0 (modulo 8).

12.6 Lock Detect

The output LOCK maintains a logic '1' when main phase detector indicates a lock condition. The lock condition is defined as a phase difference of less than 1 period of the frequency at the input XTAL_1, XTAL_2. Out of lock (logic '0') is indicated when the synthesizer is powered down.

12.7 Power-down mode

The power-on signal is defined by the bit ON in Synthesizer Register B. If ON = '1', the synthesizer section is powered on/off as defined by the chip mode (register 0x04). If ON = '0', it is defined as inverted to the chip mode. When the synthesizer is reactivated after power-down, the main and reference dividers are synchronized to avoid possibility of random phase errors on power-up.

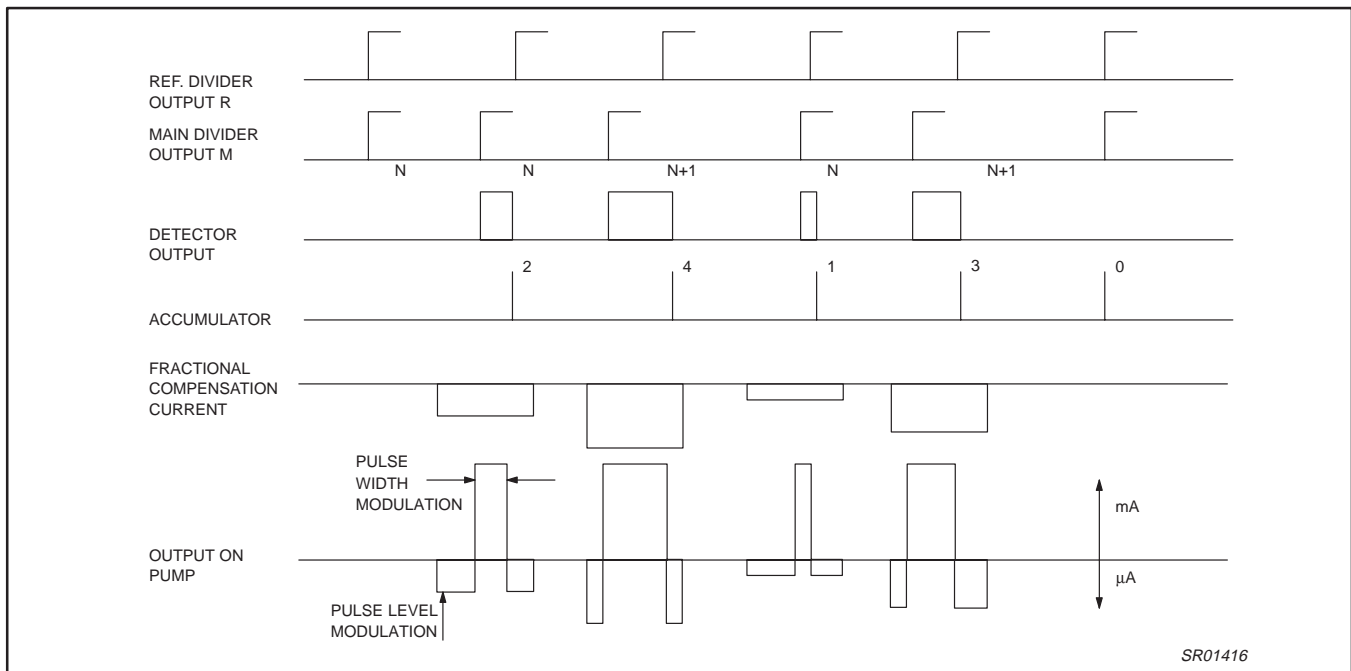

NOTE: For a proper fractional compensation, the area of the fractional compensation current pulse must be equal to the area of the charge pump ripple output.

Figure 7. Waveforms for NF = 2 Modulo 5 → fraction = 2/5

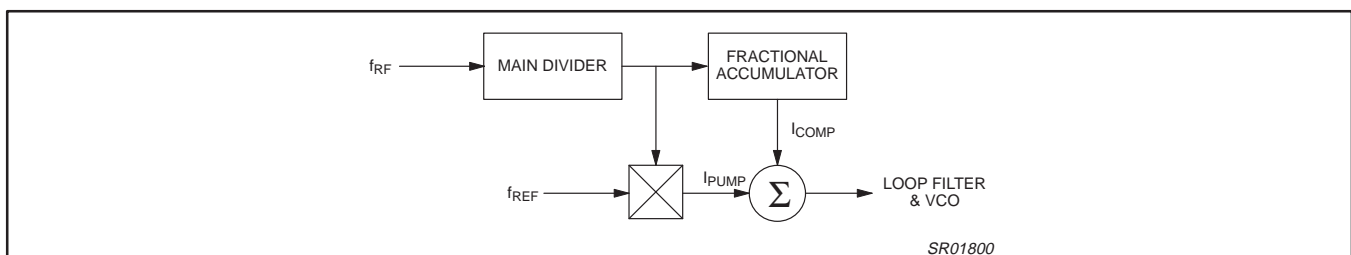

Figure 8. Current Injection Concept

Single chip transceiver for 2.45 GHz ISM band

SA2400A

13. SA2400A OTHER FUNCTIONALITY

Table 10 specifies functionality not described elsewhere in this document.

Table 10. SA2400A Other Functionality

T_{amb} = 25 °C; V_{CC} = 3.3 V

PARAMETER	TEST CONDITIONS	LIMITS			UNITS
		Min	Typ	Max	
Reference voltage output, pin V_2P5	I _{LOAD} < 2 mA, C _{LOAD} < 10 pF; switched on via register 0x04 bit 14 = '1'	2.25	2.5	2.75	V
Reference current output, pin IDCOUT	Register 0x04 bit 12 = '1'; "sink current" measured from supply to IC pin	0.25	0.3	0.35	mA
	Register 0x04 bit 13 = '1'; "source current" measured from IC pin to ground	0.85	1.0	1.15	mA

14. 3-WIRE BUS/LOGIC CONTROL

A simple 3-line bi-directional serial bus is used to program the circuit. The 3 lines are SDATA, SCLK and SEN. The SDATA line is bi-directional while the SCLK and SEN signals are always supplied externally:

- The pin SEN is an "enable" signal. It is level sensitive: If SEN is of LOW value, the 3-wire bus interface on the SA2400A is enabled. This means that each rising edge on the SCLK pin (see below) will be taken as a shift cycle, and address/data bits are expected on SDATA (see below). If SEN is HIGH, the 3-wire bus interface is disabled. No register settings will change regardless of activity on SCLK and SDATA.
- The pin SCLK is the "shift clock" input. If the 3-wire bus is enabled, address or data bits will be clocked in from the SDATA pin with rising edges of SCLK. In output mode, SDATA bits are set on the falling edge of SCLK in order to be sampled on the rising edge by the controller.
- The pin SDATA is the bi-directional "data" pin. It is internally configured as "input" or "output" depending on the operation (WRITE or READ).

Each operation consists of 32 bits. Out of these, the first 7 bits form an address word, followed by a READ/WRITE indicator bit. The following 24 bits are the data word corresponding to the chosen address.

The 3-wire bus interface contains an internal counter (state machine) which determines beginning and end of address and data word, the "write" pulse to the internal registers, and the direction of the bi-directional SDATA pin. Consequently, with the 32nd rising SCLK edge of a WRITE cycle, the current data word is stored in the internal register of the programmed address. Following SCLK edges will be taken as the beginning of the following cycle. No programming on SEN is needed to separate cycles.

If the SEN signal is switched to HIGH (i.e., DISABLE) at any time, the current cycle will be disregarded. Any bits that have been shifted in so far via SDATA will be disregarded. The internal counter is reset to zero.

14.1 Description of WRITE cycle

1. (start) SEN is LOW or is changed to LOW, i.e., 3-wire interface is enabled.
2. (SCLK edge 1 through 7) 7 address bits are clocked in, LSB first. The bit values on SDATA are taken over with rising edges on SCLK.
3. (SCLK edge 8) The READ/WRITE bit is clocked in with the rising edge of SCLK. '1' = WRITE, '0' = READ.
4. (SCLK edges 9 through 32) 24 data bits are clocked in, LSB first, with rising edges of SCLK. With the 32nd rising edge of SCLK, the whole data word is stored in the internal register according to the selected address.

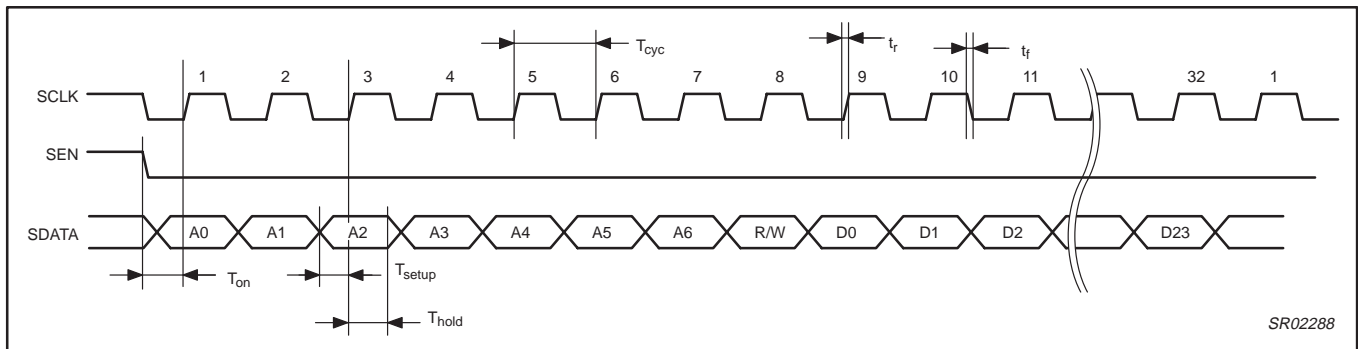

Figure 9. WRITE cycle timing diagram of the 3-wire bus

Single chip transceiver for 2.45 GHz ISM band

SA2400A

14.2 Description of READ cycle

1. (start) SEN is LOW or is changed to LOW, i.e., 3-wire interface is enabled.
2. (SCLK edge 1 through 7) 7 address bits are clocked in, LSB first. The bit values on SDATA are taken over with rising edges on SCLK.
3. (SCLK edge 8) The READ/WRITE bit is clocked in with the rising edge of SCLK. '1' = WRITE, '0' = READ.
4. (SCLK edges 9 through 32) 24 data bits are clocked out, LSB first. The bits will be available on the SDATA pin with the *falling* edges of SCLK (so bits can be accepted by the baseband IC with the following rising edge).

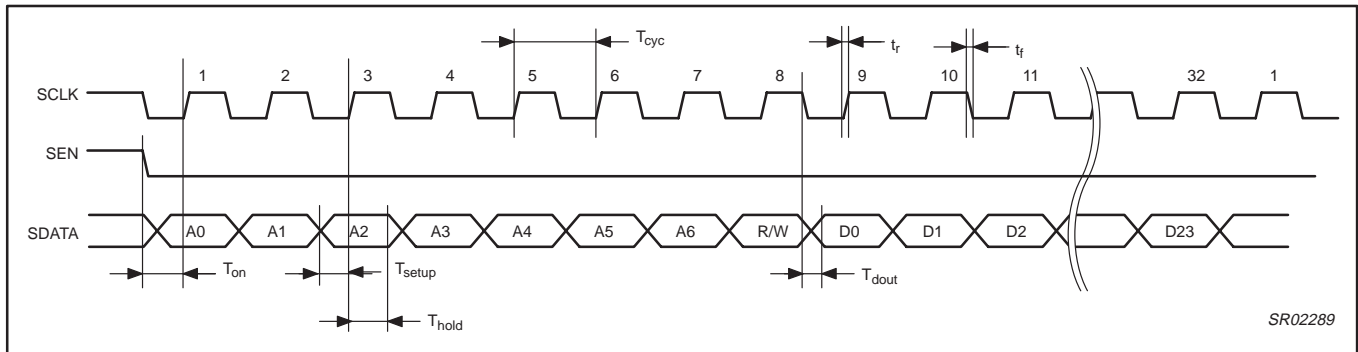

Figure 10. READ cycle timing diagram of the 3-wire bus

The fully static CMOS design uses virtually no current when the bus is inactive. It can always capture new data even during power-down. The data remains latched during power-down (sleep mode).

14.3 3-wire bus/logic control AC characteristics

Table 11. 3-wire bus/logic control AC characteristics

SYMBOL	PARAMETER	TEST CONDITIONS	LIMITS			UNITS
			Min	Typ	Max	
Serial Bus Logic Level Requirements						
V _{IH}	HIGH logic input voltage		0.5×V _{DD}	–	V _{DD} + 0.3	V
V _{IL}	LOW logic input voltage		–0.3	–	0.2×V _{DD}	V
Serial Programming Clock, SCLK						
t _r	Input rise time		–	10	40	ns
t _f	Input fall time		–	10	40	ns
T _{cyc}	Clock period		22	100	–	ns
Enable Programming, SEN						
T _{on}	Delay to rising clock edge		10	–	–	ns
Data Programming, SDATA						
T _{setup}	Input data to clock set-up time	–	10	–	–	ns
T _{hold}	Input data to clock hold time	–	10	–	–	ns
T _{dout}	Output data to clock delay time (falling edge)	–	–	–	10	ns

Single chip transceiver for 2.45 GHz ISM band

SA2400A

14.4 3-wire bus control register map

14.4.1 Data Format

Table 12. Format of programmed data

LAST IN (MSB)												FIRST IN (LSB)											
23	22	21	20	19	18	17	16	15	14	13	12	11	10	9	8	7	6	5	4	3	2	1	0

Table 13. Overview

Address	Description
00	Synthesizer: Main divider settings WRITE ONLY
01	Synthesizer: Reference divider and fractional compensation WRITE ONLY
02	Synthesizer: charge pump current and additional division WRITE ONLY
03	Synthesizer: test modes WRITE ONLY
04	Main operation modes, filter tuner, other controls
05	Rx AGC adjustment settings
06	Manual receiver control settings
07	Transmitter settings
08	VCO settings (only bits 0 through 9)

NOTES:

1. The synthesizer registers (addresses 00 to 03) cannot be read.
2. After programming register 0x01 it is necessary to also program register 0x00 to load the content of FC[7:0] into the internal working register.
3. After programming register 0x00 it is necessary to program some other register (e.g., 0x04) to avoid keeping the charge pump current setting in php-speedup mode.
4. After running the VCOCALIB mode, it is necessary to re-program registers 0x00 through 0x03.

Table 14. Address 00: Synthesizer Register A

Note: Bits 22, 23 not used.

Main divider register

Bit	21	20	19	18	17	16	15	14	13	12	11	10	9	8	7	6	5	4	3	2	1	0	
Name	FM	NF[2:0]			N[15:0]																		unused
Default	0	1	0	0	0	0	0	0	0	0	1	0	0	1	1	0	0	1	1	1	1	0	0

Bit	Description
FM	Fractional modulus select. 0->/8; 1->/5; default: 0
NF[2:0]	Fractional increment value (0 to 7); default: 4
N[15:0]	Main divider division ration (512 to 65535); default: 615

Table 15. Address 01: Synthesizer Register B

Note: Bits 22, 23 not used.

Bit	21	20	19	18	17	16	15	14	13	12	11	10	9	8	7	6	5	4	3	2	1	0
Name	R[9:0]										L	ON	FC[7:0]									
Default	0	0	0	0	0	0	1	0	1	1	1	0	1	1	0	1	0	1	0	0	0	0

Bit	Description
R[9:0]	Reference divider ratio (4 to 1023); default: 11
L[1:0]	lock detect mode 00-> inactive 01-> inactive 10->lock detect normal mode 11->inactive
ON	Power On/Off 1: as defined by chip mode (register 0x04) 0: inverted chip mode control
FC[7:0]	Fractional compensation charge pump current DAC (0 to 255); default: 80

Single chip transceiver for 2.45 GHz ISM band

SA2400A

Table 16. Address 02: Synthesizer Register C

Note: Bits 22, 23 not used.

Bit	21	20	19	18	17	16	15	14	13	12	11	10	9	8	7	6	5	4	3	2	1	0
Name	unused														CP[1:0]		SM[2:0]			'0'	unused	
Default	0	0	0	0	0	0	0	0	0	0	0	0	0	0	1	0	0	0	0	0	0	0

Bit	Description
CP[1:0]	Charge pump current setting
SM[2:0]	Comparison divider select Adds an extra divider at the end of the reference divider: $\text{extra division ratio} = 2^{\text{SM}}$ (SM = 0 to 4)

CP[1:0]	php	php-speedup
00	480 μA	2.4 mA
01	160 μA	800 μA
10	480 μA	2.4 mA
11	160 μA	800 μA

php-speedup is activated when the speed-up bit is 1 (T_{spu} in synthesizer register D). **php-speedup** is also entered after sending a synthesizer register A word and stays active until a different word is sent. To prevent frequency deviations when leaving the speedup mode when programming new words, **it is recommended to keep the speedup mode always disabled by setting the T_{phpsu} (0x03, bit 16) to '1'**.

NOTE: The only recommended charge pump current setting mode is CP[1:0] = 10, php-speedup not activated.

Table 17. Address 03: Synthesizer Register D

Note: Bits 22, 23 not used.

Bit	21	20	19	18	17	16	15	14	13	12	11	10	9	8	7	6	5	4	3	2	1	0	
Name	'00000'					T_{phpsu}	T_{spu}	'00000000000000'														unused	
Default	0	0	0	0	0	0	0	0	0	0	0	0	0	0	0	0	0	0	0	0	0	0	0

Bit	Description
T_{phpsu}	1 → disable PHP speedup pump, overrides function of T_{spu}
T_{spu}	1 → speedup ON 0 → speedup OFF

Single chip transceiver for 2.45 GHz ISM band

SA2400A

Table 18. Address 04: Main chip operation modes, filter tuner, other controls

Bit	23	22	21	20	19	18	17	16	15	14	13	12	11	10	9	8	7	6	5	4	3	2	1	0
Name	'0000'				adc	fterr	Filttune		v2p5	l1m	l0p3	n.u.	in22	clk	xo	digin	rxlv	veo	vei	Chip mode				
Default	0	0	0	0	0	0	0	1	1	0	0	1	0	0	1	1	0	0	0	0	0	0	0	0

Bit #	Name	Description																																																		
0–3	Chip mode	Main mode of operation. Coding according to following table:																																																		
		<table border="1"> <thead> <tr> <th>Bit3</th><th>Bit2</th><th>Bit1</th><th>Bit0</th><th>Mode</th></tr> </thead> <tbody> <tr><td>0</td><td>0</td><td>0</td><td>0</td><td>SLEEP</td></tr> <tr><td>0</td><td>0</td><td>0</td><td>1</td><td>TX/RX</td></tr> <tr><td>0</td><td>0</td><td>1</td><td>0</td><td>WAIT</td></tr> <tr><td>0</td><td>0</td><td>1</td><td>1</td><td>RXMGC</td></tr> <tr><td>0</td><td>1</td><td>0</td><td>0</td><td>FCALIB</td></tr> <tr><td>0</td><td>1</td><td>0</td><td>1</td><td>DCALIB</td></tr> <tr><td>0</td><td>1</td><td>1</td><td>0</td><td>FASTTXRXMGC</td></tr> <tr><td>0</td><td>1</td><td>1</td><td>1</td><td>RESET</td></tr> <tr><td>1</td><td>0</td><td>0</td><td>0</td><td>VCOCALIB</td></tr> </tbody> </table>	Bit3	Bit2	Bit1	Bit0	Mode	0	0	0	0	SLEEP	0	0	0	1	TX/RX	0	0	1	0	WAIT	0	0	1	1	RXMGC	0	1	0	0	FCALIB	0	1	0	1	DCALIB	0	1	1	0	FASTTXRXMGC	0	1	1	1	RESET	1	0	0	0	VCOCALIB
Bit3	Bit2	Bit1	Bit0	Mode																																																
0	0	0	0	SLEEP																																																
0	0	0	1	TX/RX																																																
0	0	1	0	WAIT																																																
0	0	1	1	RXMGC																																																
0	1	0	0	FCALIB																																																
0	1	0	1	DCALIB																																																
0	1	1	0	FASTTXRXMGC																																																
0	1	1	1	RESET																																																
1	0	0	0	VCOCALIB																																																
		Notes on modes:																																																		
		<ul style="list-style-type: none"> All calibration modes (*CALIB) require the crystal oscillator to be ON (bit XO = 1). DCALIB (Tx LO leakage calibration) requires being in Tx mode for 5 μs before calibration. 																																																		
4	vei	Use external vco input (vcoextin)																																																		
5	veo	Make internal vco available at vco pads (vcoextout)																																																		
6	rxlv	Rx output common mode voltage: $0-V_{DD}/2$, 1–1.25 V																																																		
7	digin	Use digital Tx inputs (FIRDAC)																																																		
8	xo	Xtal oscillator ON																																																		
9	clk	Reference clock output ON																																																		
10	in22	Xtal input frequency: 0–44 MHz, 1–22 MHz																																																		
11		Not used																																																		
12	l0p3	External reference current (pad idcout): 0.3 mA to ground																																																		
13	l1m	External reference current (pad idcout): 1.0 mA from supply																																																		
14	v2p5	External reference voltage (pad v2p5) ON																																																		
15–17	filttune	Rx and Tx filter tuning bits: Write: (with test mode only), these bits set tuning value Read: (in normal mode) tuner setting can be read out here																																																		
18	fterr	Filter tuner error (read only): result is 1 when tuner exceeded range																																																		
19	adc	'1': in Rx mode, the RSSI-ADC is always on. '0': the RSSI-ADC is only on during AGC operation.																																																		

Table 19. Address 05: AGC adjustment settings

Bit	23	22	21	20	19	18	17	16	15	14	13	12	11	10	9	8	7	6	5	4	3	2	1	0
Name	Rx AGC target				Rx AGC Gmax				AGC_bbdel/ADCval				AGC_inadel/sample2				AGC_rxondel/sample1							
Default	$\pm(0)$		val(000)		79 dB – 11001				7(1.3 μ s) – 00111				15(2.7 μ s) – 01111				27(4.9 μ s) – 11011							

Bit #	Name	Description
0–4	AGC_rxondel/s1	Write: Programmable delay for AGC algorithm: Rx turn-on to AGCSET. In units of 182 ns (5.5 MHz) Read: 1 st sample of RSSI in AGC cycle
5–9	AGC_inadel/s2	Write: Programmable delay for AGC algorithm: Settling time after LNA gain switching. In units of 182 ns (5.5 MHz) Read: 2 nd sample of RSSI in AGC cycle
10–14	AGC_bbdel/ADCval	Write: Programmable delay for AGC algorithm: Settling time after baseband gain switching. In units of 182 ns (5.5 MHz) Read: Output of RSSI/Tx-peak detector ADC in 5-bit Gray code
15–19	AGC Gmax	Rx AGC gain limit (54 dB + programmed value) (valid: 54 through 85)
20–23	AGC target	Adjustment value to AGC settling target, range –7 dB ... 7 dB (sign plus three bits)

Single chip transceiver for 2.45 GHz ISM band

SA2400A

Table 20. Address 06: Manual receiver control settings

Bit	23	22	21	20	19	18	17	16	15	14	13	12	11	10	9	8	7	6	5	4	3	2	1	0	
Name	ahsn	osQ	rxosQval			osl	rxoslval			ten	Corner f	Receiver gain													
Default	0	0	±(0)	val (000)			0	±(0)	val (000)			1	0	0	1	1	1	1	1	1	1	1	1	1	1
Bit #	Name	Description																							
0–9	receiver gain	Write: In RXMGC mode, this sets the receiver gain. Read: In other modes, the AGC controlled gain is available for readout here. Bit positions: 0–plus1dB; 1–vga2dB; 2–vga4dB; 3–vga8dB; 4–vga16dB; 5–vga10dB; 6–filter6dB2; 7–filter10dB; 8–filter6dB1; 9–lna16dB																							
10–11	corner freq.	DC offset cancellation cornerpoint select. Write: In RXMGC mode, this sets the cornerpoint. Read: In other modes, the cornerpoint as controlled by the AGC is available for readout here. Code: 00–10 kHz, 01–100 kHz, 10–1 MHz, 11–10 MHz																							
12	ten	Use 10 MHz offset cancellation cornerpoint for brief period after each gain change																							
13–22	Rx offset I,Q	Receiver output driver manual offset adjustment. Code: {rxosXon,rxosXval} = '0xxxx' → offset = 0; {rxosXon,rxosXval} = '10000' → offset = 8 mV; {rxosXon,rxosXval} = '11000' → offset = –8 mV; {rxosXon,rxosXval} = '10001' → offset = 16 mV etc.																							
13–16	rxoslval	Rx offset correction, I channel, value (sign plus three bits)																							
17	rxoslon	Rx offset correction, I channel, ON																							
18–21	rxosQval	Rx offset correction, Q channel, value (sign plus three bits)																							
22	rxosQon	Rx offset correction, Q channel, ON																							
23	ahsn	AGC with high Signal-to-Noise (switch LNA at step 52 instead of step 60). Recommended to set to '1'.																							

Table 21. Address 07: Transmitter settings

Bit	23	22	21	20	19	18	17	16	15	14	13	12	11	10	9	8	7	6	5	4	3	2	1	0	
Name	'0000'			osQ	TxosQval			osl	txoslval			txramp	Tx gain hi			Tx gain low									
Default	0	0	0	0	0	±(0)	val (000)			0	±(0)	val (000)			0	0	0 dB (0000)			15 dB (1111)					
Bit #	Name	Description																							
0–3	Tx gain low	Transmitter gain settings for TXLO output																							
4–7	Tx gain hi	Transmitter gain settings for TXHI output																							
8–9	txramp	Tx ramp-up delay programming: 00–1 μs, 01–2 μs, 10–3 μs, 11–4 μs. Ramp-up time always 1 μs.																							
10–19	Tx offset I, Q	Tx carrier leakage calibration: Write: with test mode, these bits set the offset. Read: in normal mode, automatically controlled settings can be read out here (sign plus three bits). Code: {txosXon,txosXval} = '0xxxx' → offset = 0; {txosXon,txosXval} = '10000' → offset = 2.5 μA; {txosXon,txosXval} = '11000' → offset = –2.5 μA; {txosXon,txosXval} = '10001' → offset = 5.0 μA etc.																							
10–13	txoslval	Tx offset correction, I channel, value (sign plus three bits)																							
14	txoslon	Tx offset correction, I channel ON																							
15–18	txsoQval	Tx offset correction, Q channel, value (sign plus three bits)																							
19	txosQon	Tx offset correction, Q channel ON																							

Table 22. Address 08: VCO settings

Bit	23	22	21	20	19	18	17	16	15	14	13	12	11	10	9	8	7	6	5	4	3	2	1	0	
name	these bits do not exist on IC												not used			'0'	'0'	vcerr			vcoband				
default	x	x	x	x	x	x	x	x	x	x	x	x	x	x	0	0	0	0	0	0	0	0	0	0	
Bit #	Name	Description																							
0–3	vcoband	VCO band. Write: with test mode, these bits set the VCO band. Read: in normal mode, the result of the calibration (VCOCAL) can be read out here (0000 = highest frequencies).																							
4	vcerr	VCO calibration error flag (no band with low enough frequency could be found).																							

Single chip transceiver for 2.45 GHz ISM band

SA2400A

14.4.2 Programming Example

Program synthesizer for 2.412 GHz band

- Input Xtal is 44 MHz, comparison frequency $f_{comp} = 4$ MHz \Rightarrow reference division ratio $R = 11$
- Target frequency is 2412 MHz, $f_{comp} = 4$ MHz \Rightarrow main divider ratio $N = 603$ (no fractional N)
 - write this word to register 00: 00 0 000 0000001001011011 00 (note two leading zeros – unused bits 22, 23)
 - write this word to register 01: 00 0000001011 00 1 0 xxxxxxxx (x = no significance)

Program synthesizer for 2.462 GHz band

- Input Xtal is 44 MHz, comparison frequency $f_{comp} = 4$ MHz \Rightarrow reference division ratio $R = 11$
- Target frequency is 2462 MHz, $f_{comp} = 4$ MHz \Rightarrow main divider ratio $N = 615.5$ (fractional 4/8)
 - write this word to register 00: 00 0 100 0000001001100111 00
 - write this word to register 01: 00 0000001011 00 1 0 01010000
 Fractional compensation setting should be set in the application (depends on the loop parameters) with the help of the SA8027 application note. The nominal value is $FC = 640 / FM$ ($FM = \text{modulus}$, see address 00).

14.5 Fast serial interface for Receiver–AGC programming

When the chip is in mode “FASTTXRMGC” the internal AGC block is disabled. Instead, the 10 bits controlling the receiver gain and the two bits controlling the DC offset cancellation corner frequency can be programmed directly via a dedicated second serial interface. This interface is active when in FASTTXRMGC mode and when $SEN=HIGH$. (SEN acts as a switch between the regular serial interface and the dedicated bus).

14.5.1 Description of “fast programming” cycle

1. Set the chip to FASTTXRMGC mode by programming register 4 with the correct value.
2. Set the SEN pin to HIGH.
3. With each rising edge on pin $SCLK$, a new data bit is expected at pin $AGCRESET$. No address is needed. The sequence of the bits is the same as described for register 6, bits 0–11. The programming order is LSB first.
4. With the 12th rising edge on $SCLK$, an internal counter will automatically parallel-load the shifted-in data bits into an internal register. The bits will immediately effect the receiver settings.
5. The regular 3-wire bus is still accessible and can be programmed when SEN is LOW. Clock activity on $SCLK$ will not affect receiver gain settings when SEN is LOW.

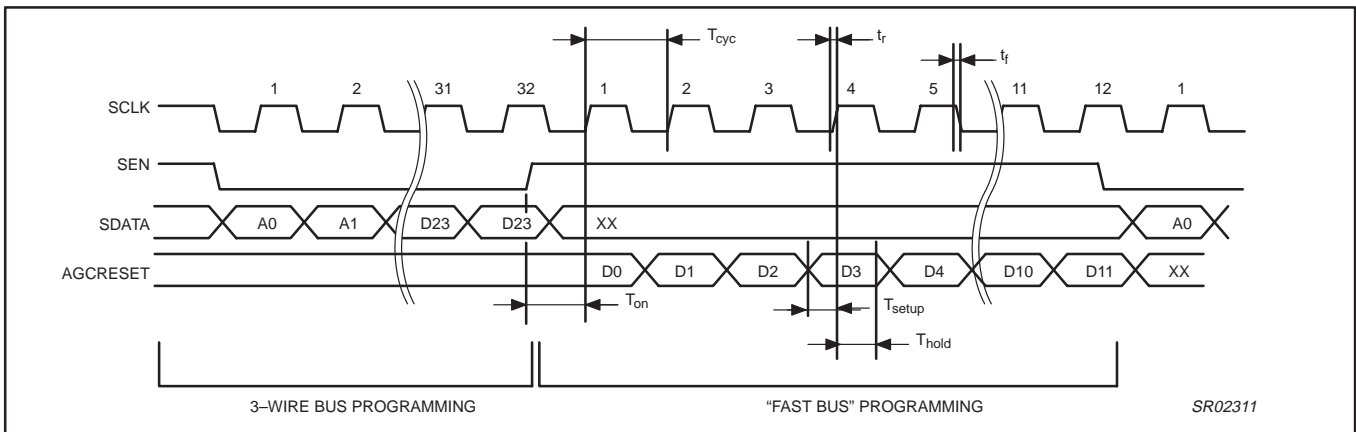

Figure 11. “Fast programming” cycle timing diagram

14.6 Fast serial interface AC characteristics

SYMBOL	PARAMETER	TEST CONDITIONS	LIMITS			UNITS
			Min	Typ	Max	
Serial Bus Logic Level Requirements						
V_{IH}	HIGH logic input voltage		$0.5 \times V_{DD}$	–	$V_{DD} + 0.3$	V
V_{IL}	LOW logic input voltage		–0.3	–	$0.2 \times V_{DD}$	V
Serial Programming Clock, SCLK						
t_r	Input rise time		–	10	40	ns
t_f	Input fall time		–	10	40	ns
T_{cyc}	Clock period		22	100	–	ns
Enable Programming, SEN						
T_{on}	Delay to rising clock edge		10	–	–	ns
Data Programming, AGCRESET						
T_{setup}	Input data to clock set-up time		10	–	–	ns
T_{hold}	Input data to clock hold time		10	–	–	ns

Single chip transceiver for 2.45 GHz ISM band

SA2400A

15. PERFORMANCE CURVES

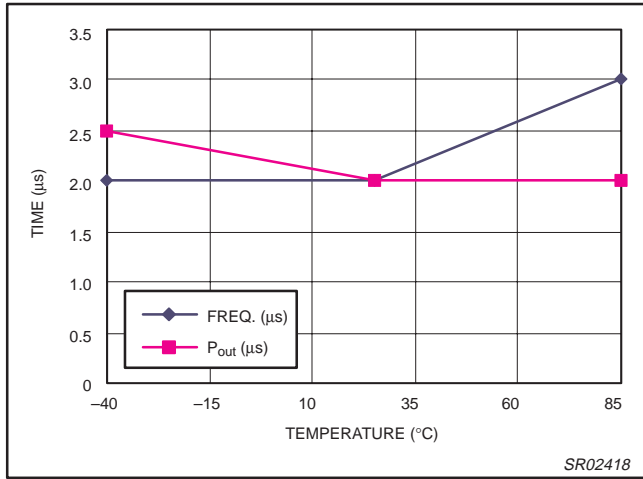

Figure 12. TX to RX switching time versus temperature (V_{DD} = 3.3 V)

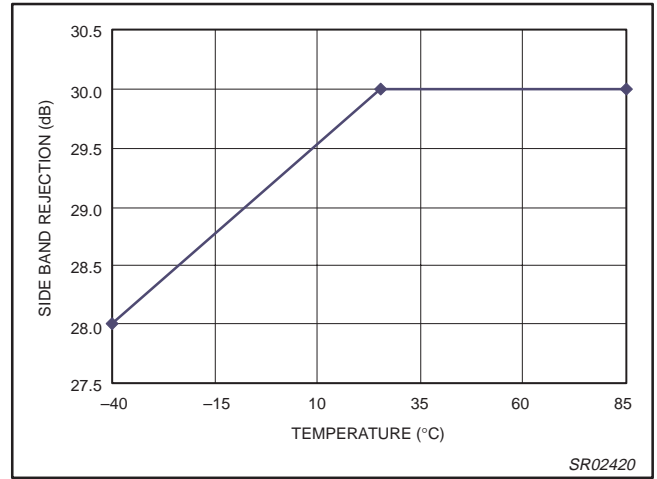

Figure 15. RX residual sideband suppression versus temperature (V_{DD} = 3.3 V)

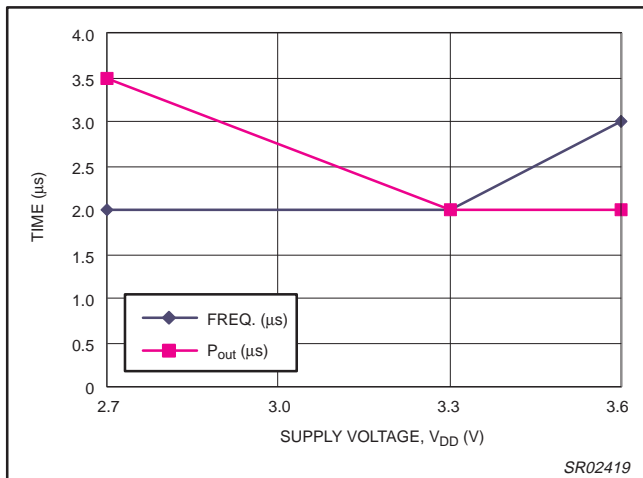

Figure 13. TX to RX switching time versus supply voltage (T_{amb} = 25 °C)

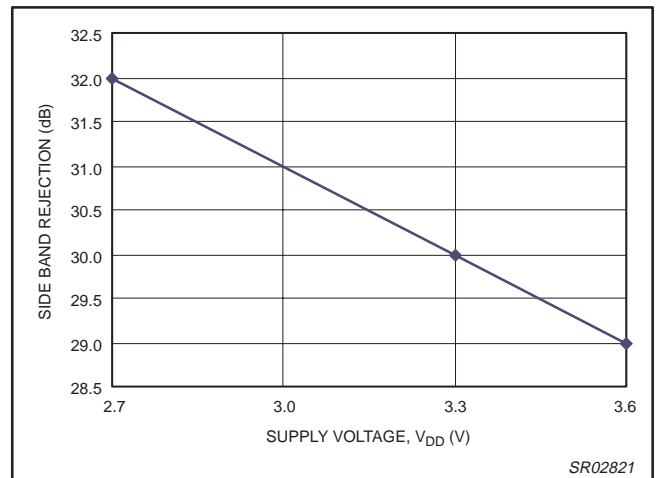

Figure 16. RX residual sideband suppression versus supply voltage (T_{amb} = 25 °C)

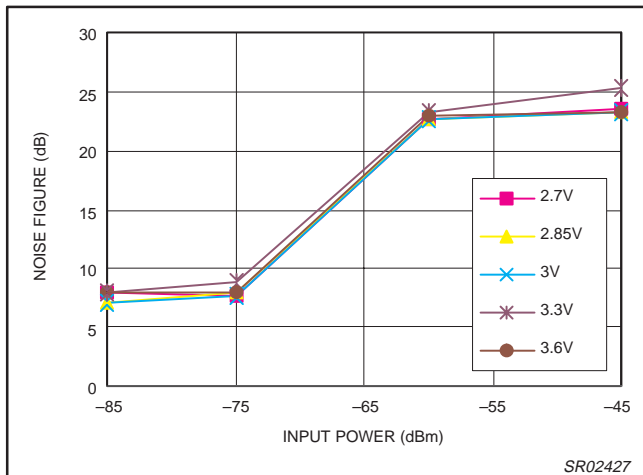

Figure 14. Noise Figure versus input power

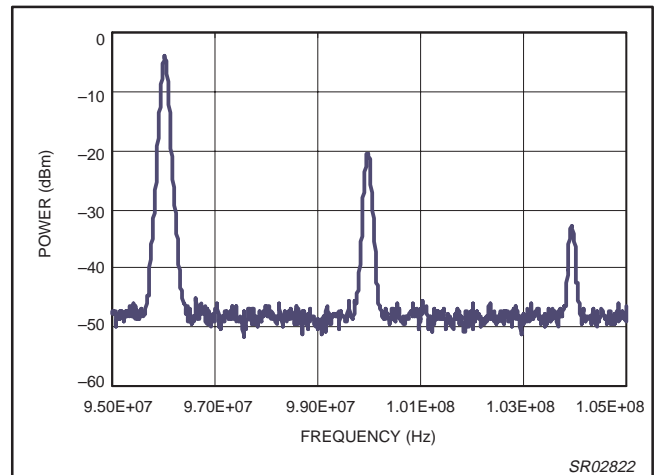

Figure 17. Spectrum of RX sideband rejection at 4 MHz offset

Single chip transceiver for 2.45 GHz ISM band

SA2400A

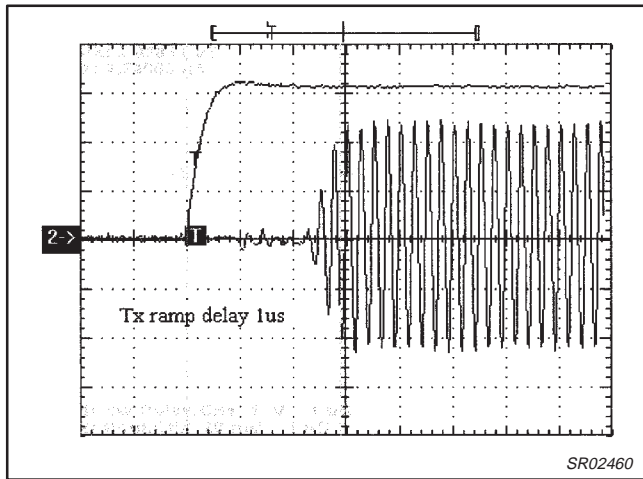

Figure 18. TX ramp-up (1 μs/div).

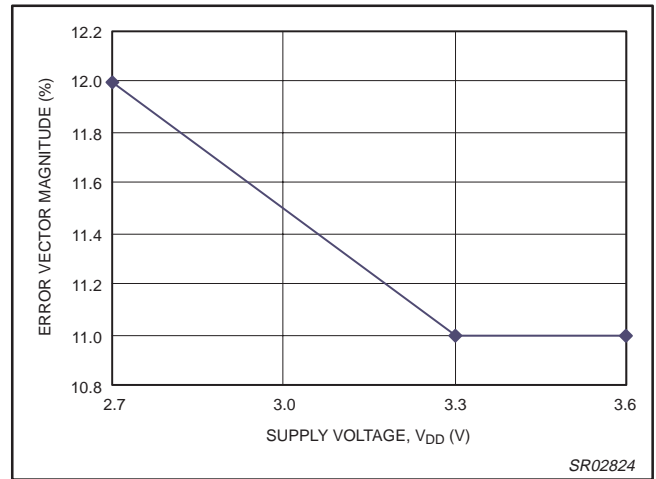

Figure 21. Transmitter error vector magnitude (EVM) versus supply voltage (T_{amb} = 25 °C).

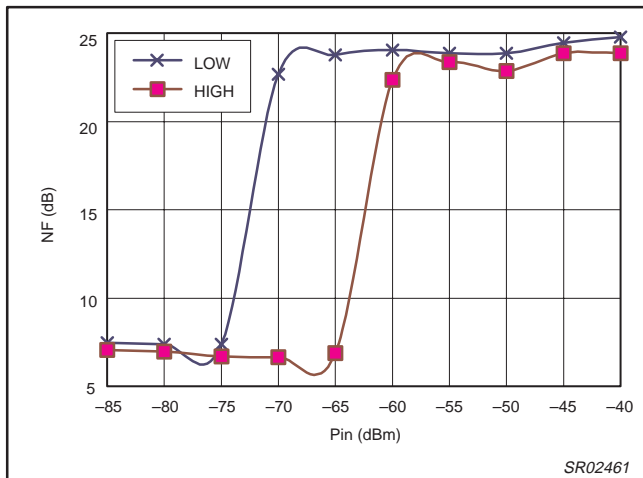

Figure 19. Noise Figure vs. input power for two LNA switching modes.

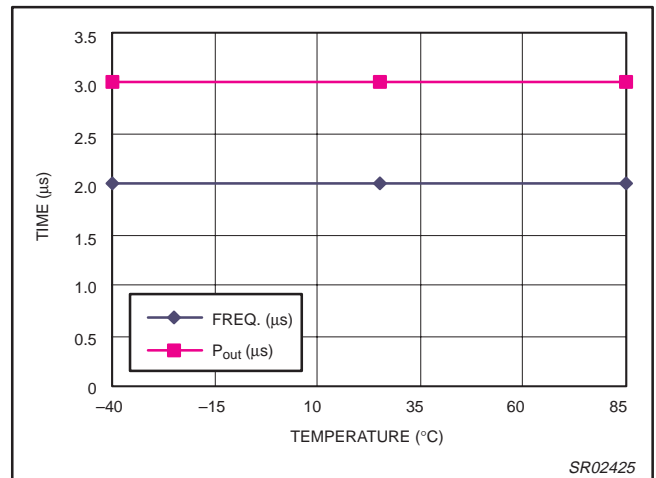

Figure 22. RX to TX switching time versus temperature (V_{DD} = 3.3 V).

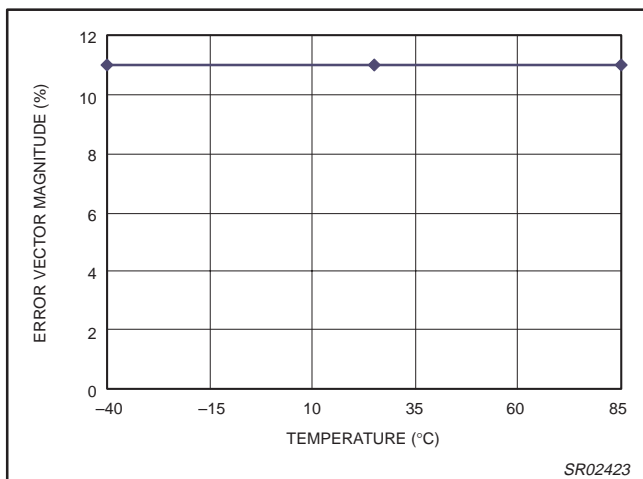

Figure 20. Transmitter error vector magnitude (EVM) versus temperature (V_{DD} = 3.3 V).

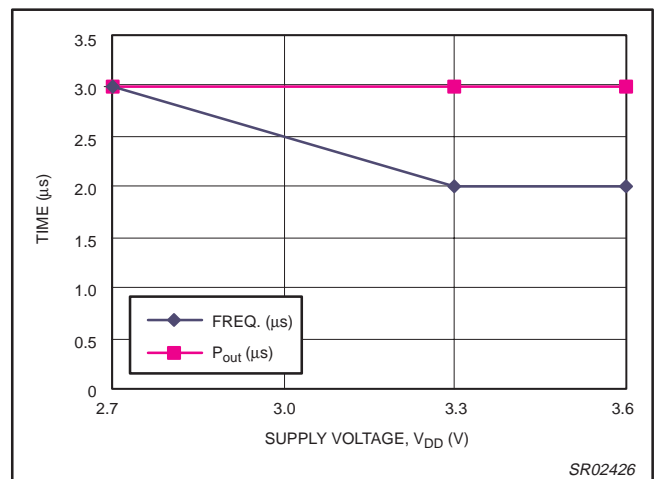

Figure 23. RX to TX switching time versus supply voltage (T_{amb} = 25 °C).

Single chip transceiver for 2.45 GHz ISM band

SA2400A

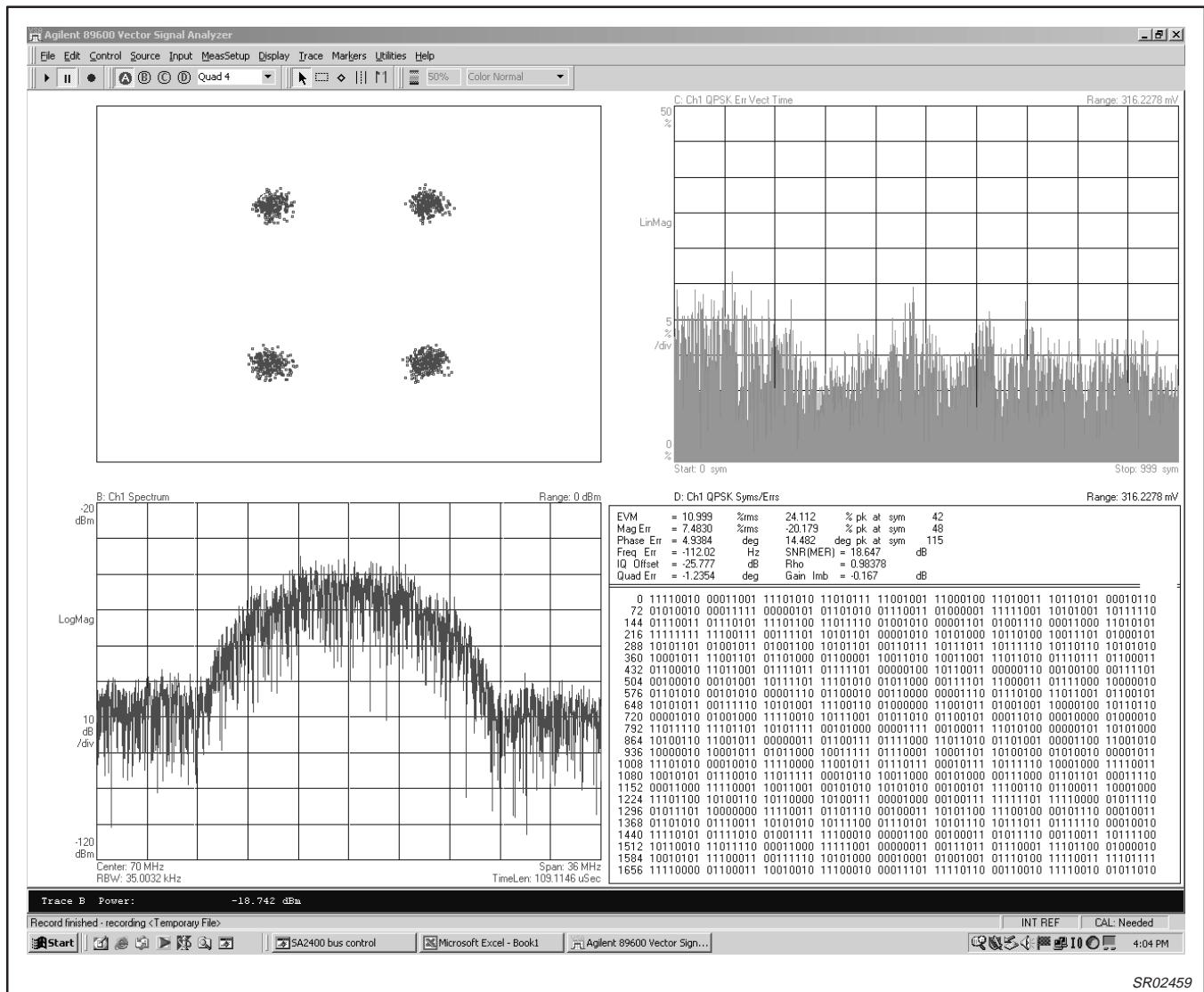

Figure 24. TX constellation and EVM.

Single chip transceiver for 2.45 GHz ISM band

SA2400A

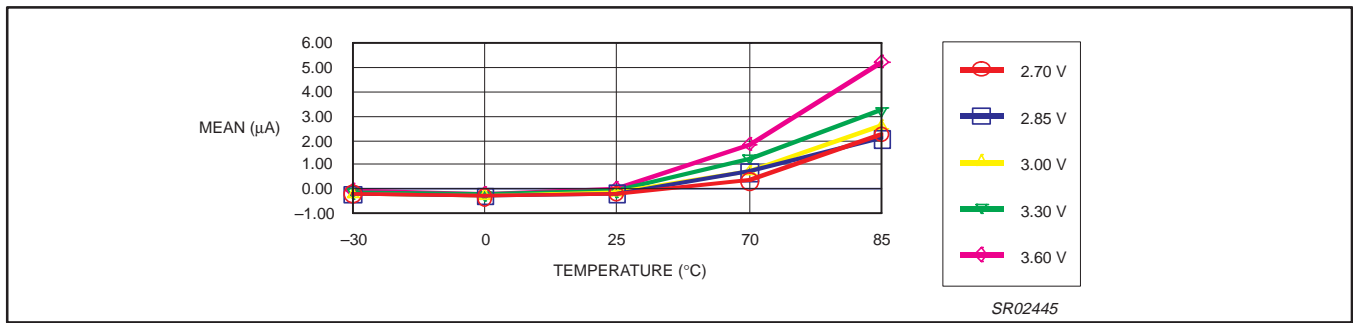

Figure 25. Total sleep I_{CC} .

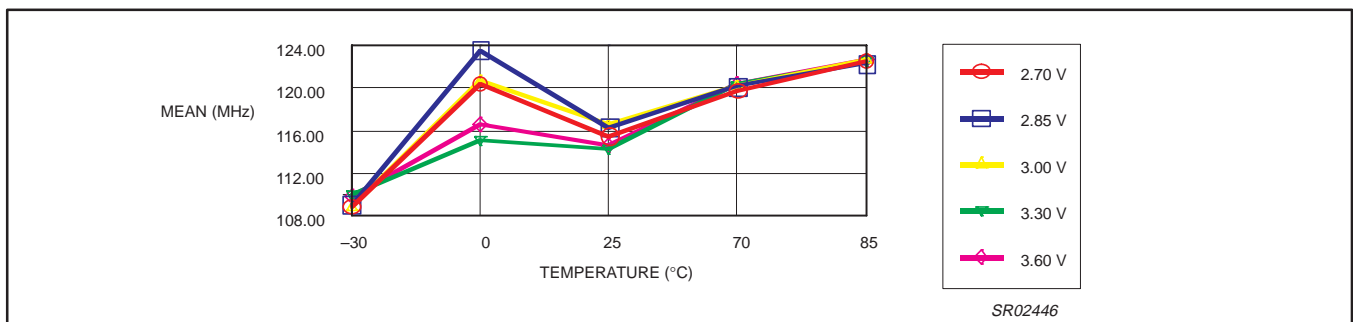

Figure 26. VCO 0011 bandwidth.

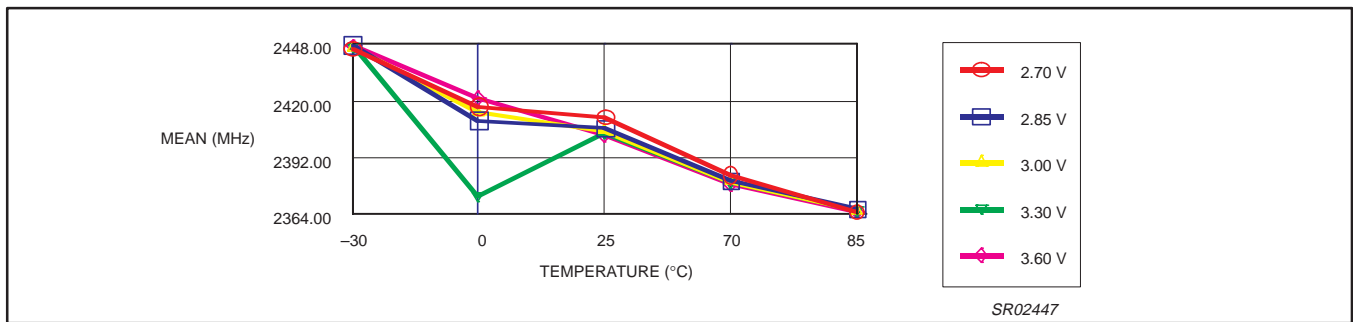

Figure 27. VCO 0111 f1.

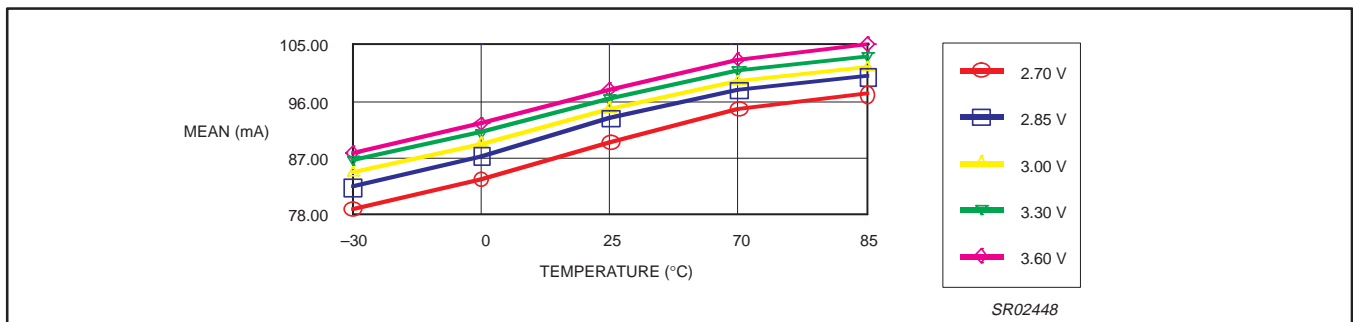

Figure 28. Total TX LOW I_{CC} .

Single chip transceiver for 2.45 GHz ISM band

SA2400A

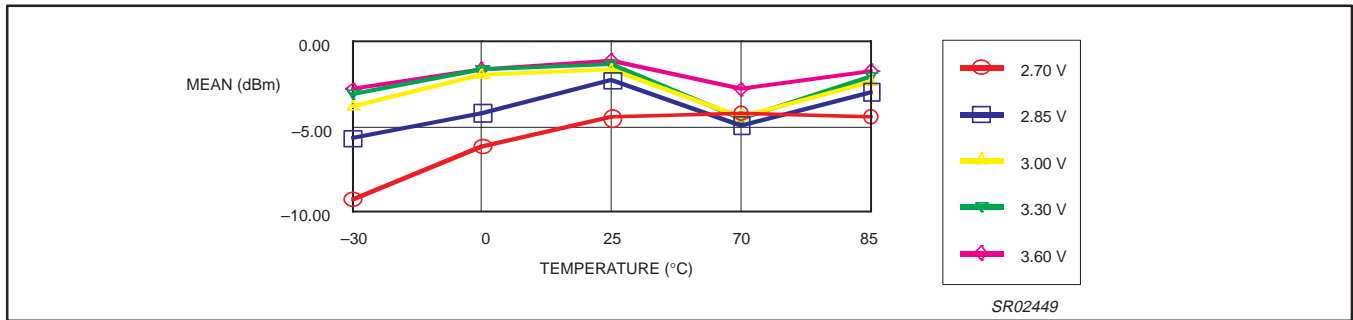

Figure 29. Output power TX LOW, g = 1111.

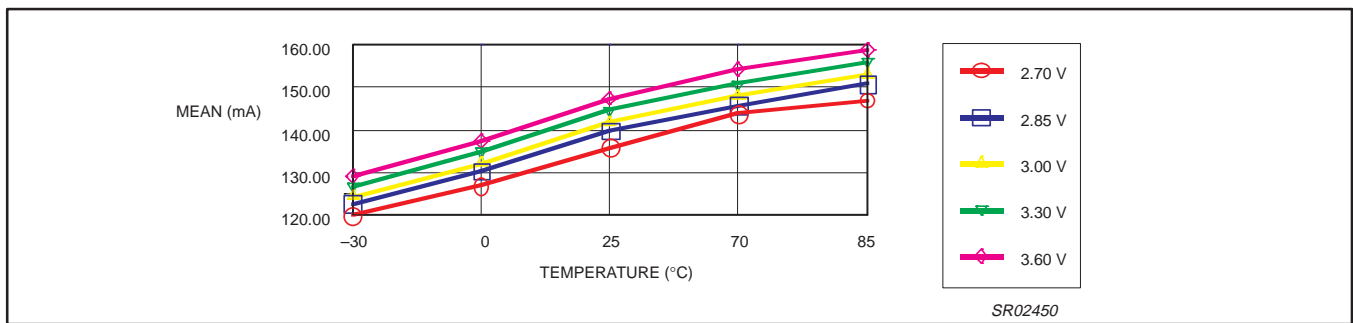

Figure 30. Total TX HIGH I_{CC}.

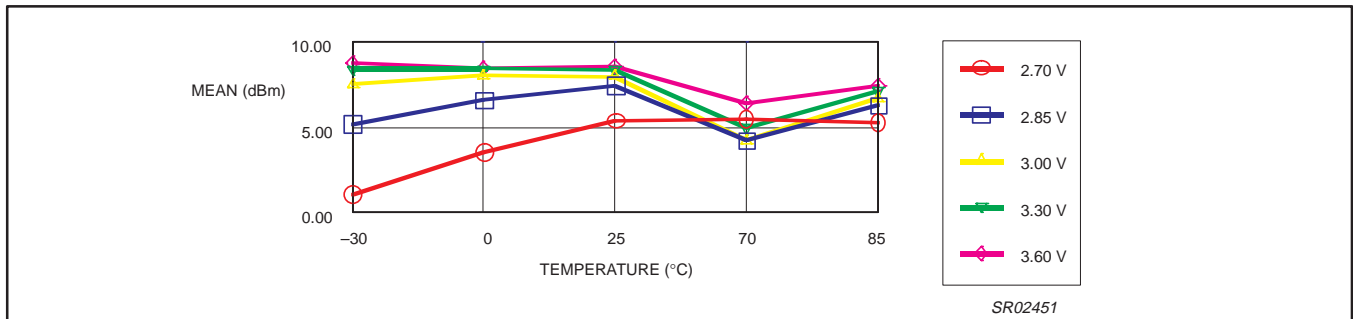

Figure 31. Output power TX HIGH, g = 1111.

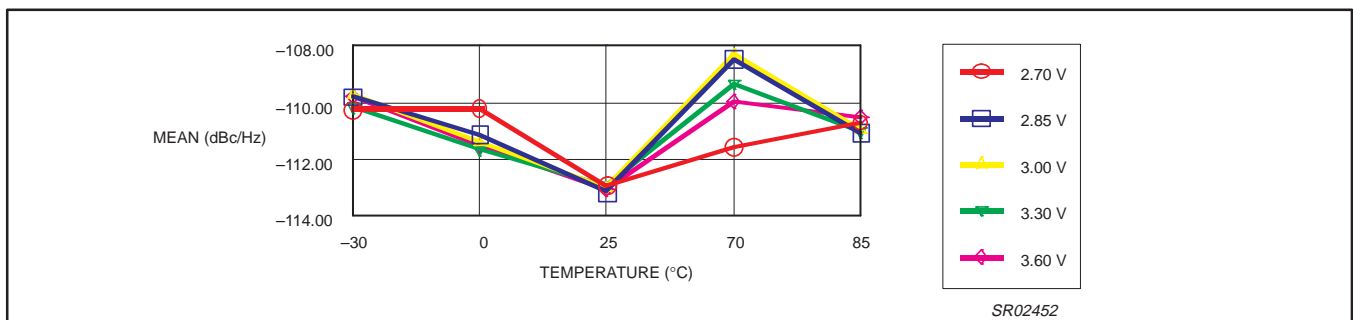

Figure 32. PLL phase noise @ 500 kHz.

Single chip transceiver for 2.45 GHz ISM band

SA2400A

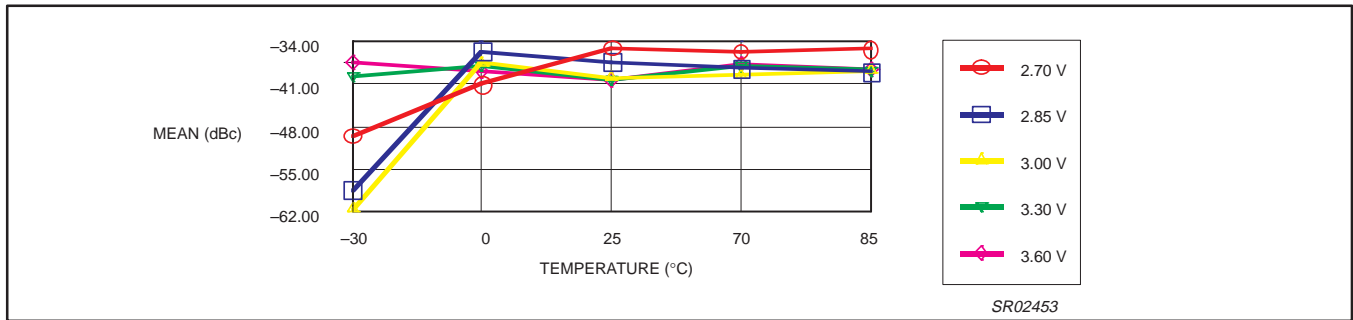

Figure 33. TX HIGH spectral mask, adjacent channel.

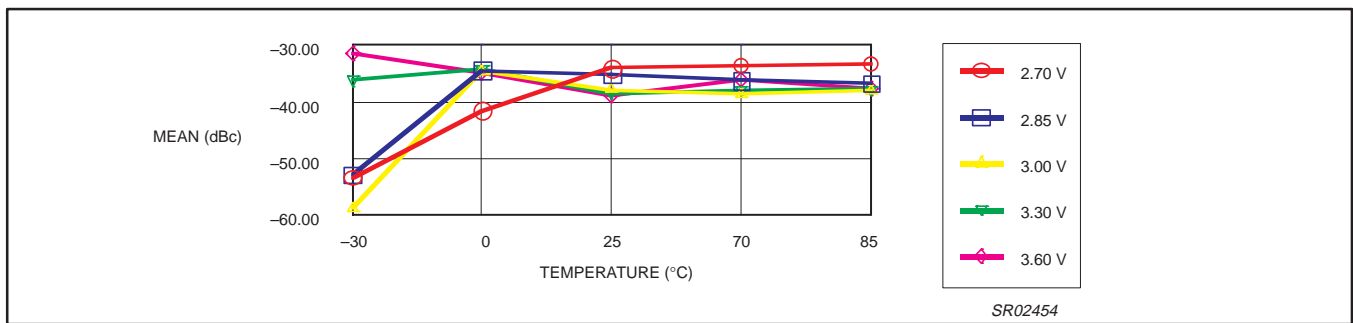

Figure 34. TX LOW spectral mask, adjacent channel.

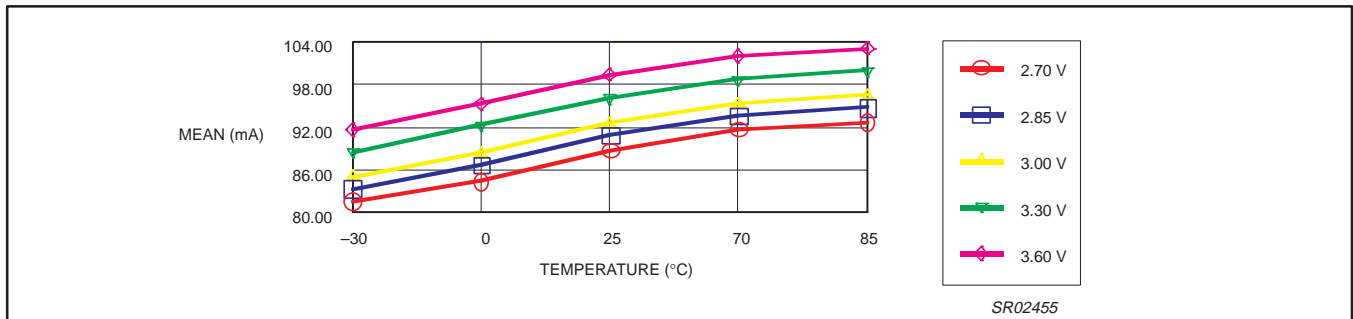

Figure 35. Total RX ICC.

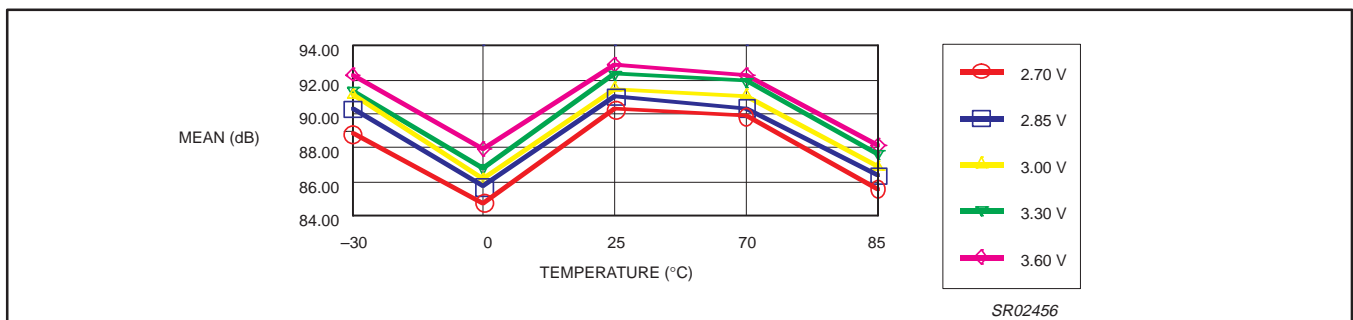

Figure 36. RXMGC I max gain.

Single chip transceiver for 2.45 GHz ISM band

SA2400A

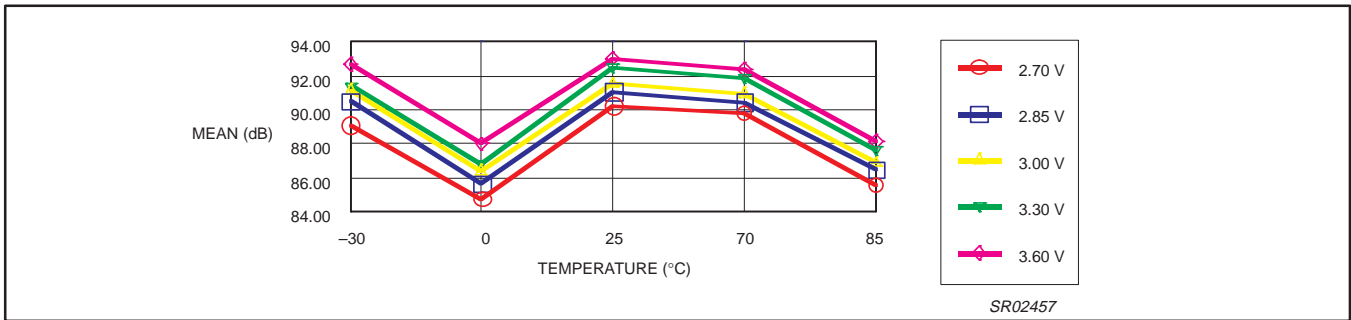

Figure 37. RXMGC Q max gain.

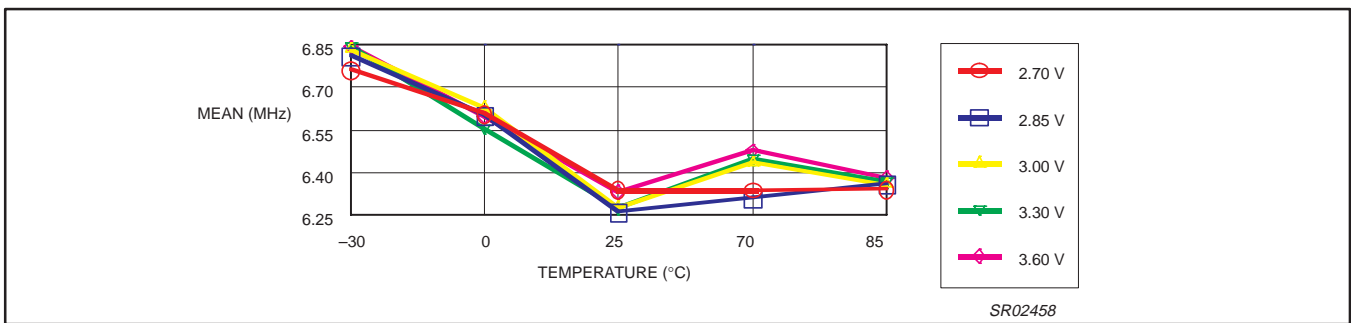

Figure 38. RX filter ripple bandwidth.

Single chip transceiver for 2.45 GHz ISM band

SA2400A

LQFP48: plastic low profile quad flat package; 48 leads; body 7 x 7 x 1.4 mm

SOT313-2

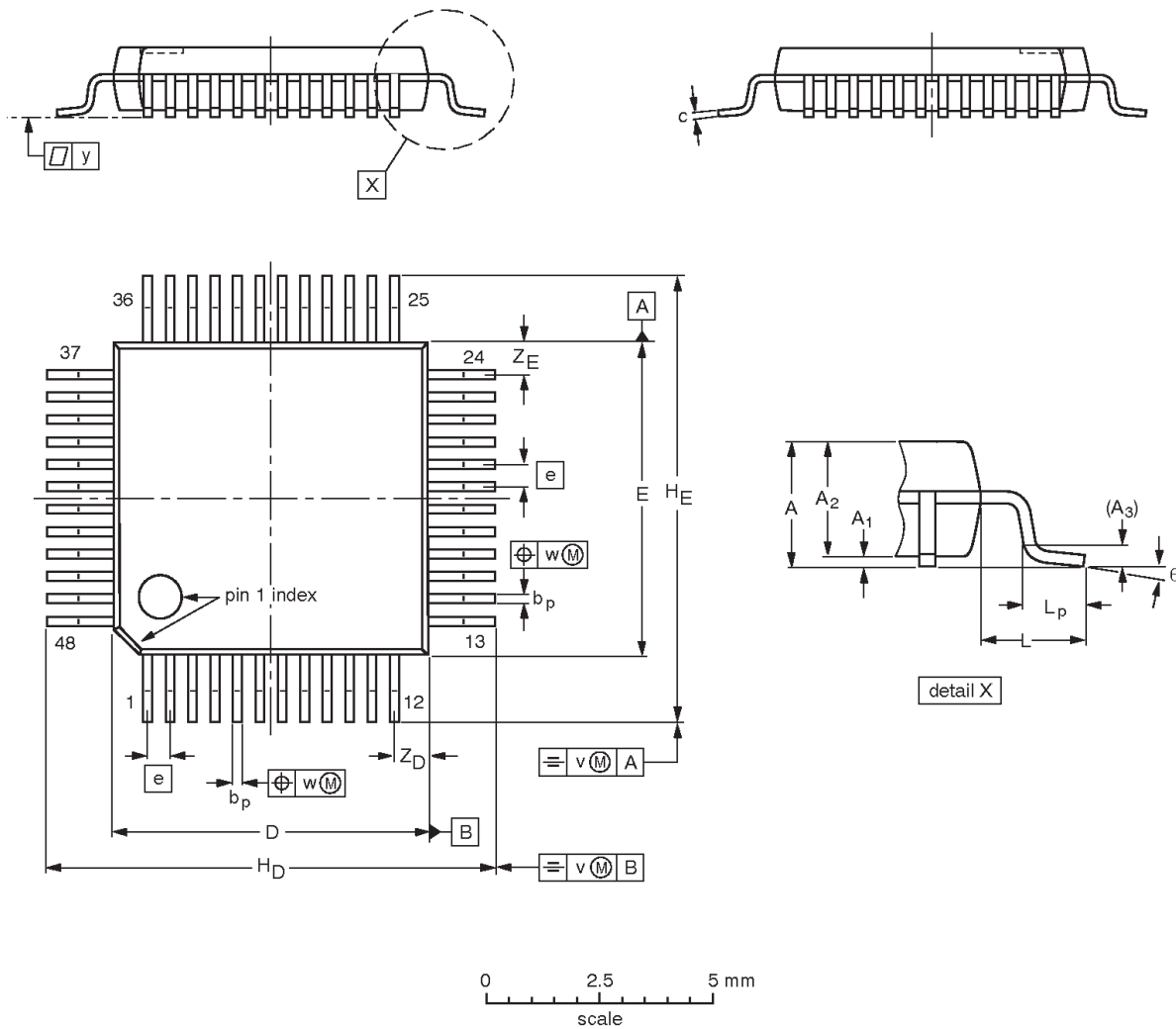

DIMENSIONS (mm are the original dimensions)

UNIT	A max.	A ₁	A ₂	A ₃	b _p	c	D ⁽¹⁾	E ⁽¹⁾	e	H _D	H _E	L	L _p	v	w	y	Z _D ⁽¹⁾	Z _E ⁽¹⁾	θ
mm	1.60	0.20 0.05	1.45 1.35	0.25	0.27 0.17	0.18 0.12	7.1 6.9	7.1 6.9	0.5	9.15 8.85	9.15 8.85	1.0	0.75 0.45	0.2	0.12	0.1	0.95 0.55	0.95 0.55	7° 0°

Note

1. Plastic or metal protrusions of 0.25 mm maximum per side are not included.

OUTLINE VERSION	REFERENCES				EUROPEAN PROJECTION	ISSUE DATE
	IEC	JEDEC	EIAJ			
SOT313-2	136E05	MS-026				99-12-27 00-01-19

Single chip transceiver for 2.45 GHz ISM band

SA2400A

REVISION HISTORY

Rev	Date	Description
_1	20021104	Product data; initial version. Engineering Change Notice 853–2320 28727 (date: 20020809).

Single chip transceiver for 2.45 GHz ISM band

SA2400A

Data sheet status

Level	Data sheet status ^[1]	Product status ^{[2] [3]}	Definitions
I	Objective data	Development	This data sheet contains data from the objective specification for product development. Philips Semiconductors reserves the right to change the specification in any manner without notice.
II	Preliminary data	Qualification	This data sheet contains data from the preliminary specification. Supplementary data will be published at a later date. Philips Semiconductors reserves the right to change the specification without notice, in order to improve the design and supply the best possible product.
III	Product data	Production	This data sheet contains data from the product specification. Philips Semiconductors reserves the right to make changes at any time in order to improve the design, manufacturing and supply. Relevant changes will be communicated via a Customer Product/Process Change Notification (CPCN).

[1] Please consult the most recently issued data sheet before initiating or completing a design.

[2] The product status of the device(s) described in this data sheet may have changed since this data sheet was published. The latest information is available on the Internet at URL <http://www.semiconductors.philips.com>.

[3] For data sheets describing multiple type numbers, the highest-level product status determines the data sheet status.

Definitions

Short-form specification — The data in a short-form specification is extracted from a full data sheet with the same type number and title. For detailed information see the relevant data sheet or data handbook.

Limiting values definition — Limiting values given are in accordance with the Absolute Maximum Rating System (IEC 60134). Stress above one or more of the limiting values may cause permanent damage to the device. These are stress ratings only and operation of the device at these or at any other conditions above those given in the Characteristics sections of the specification is not implied. Exposure to limiting values for extended periods may affect device reliability.

Application information — Applications that are described herein for any of these products are for illustrative purposes only. Philips Semiconductors make no representation or warranty that such applications will be suitable for the specified use without further testing or modification.

Disclaimers

Life support — These products are not designed for use in life support appliances, devices, or systems where malfunction of these products can reasonably be expected to result in personal injury. Philips Semiconductors customers using or selling these products for use in such applications do so at their own risk and agree to fully indemnify Philips Semiconductors for any damages resulting from such application.

Right to make changes — Philips Semiconductors reserves the right to make changes in the products—including circuits, standard cells, and/or software—described or contained herein in order to improve design and/or performance. When the product is in full production (status 'Production'), relevant changes will be communicated via a Customer Product/Process Change Notification (CPCN). Philips Semiconductors assumes no responsibility or liability for the use of any of these products, conveys no license or title under any patent, copyright, or mask work right to these products, and makes no representations or warranties that these products are free from patent, copyright, or mask work right infringement, unless otherwise specified.

Contact information

For additional information please visit
<http://www.semiconductors.philips.com>. Fax: +31 40 27 24825

© Koninklijke Philips Electronics N.V. 2002
 All rights reserved. Printed in U.S.A.

Date of release: 11-02

For sales offices addresses send e-mail to:
sales.addresses@www.semiconductors.philips.com

Document order number:

9397 750 09632

Let's make things better.