



Cascadable Silicon Bipolar MMIC Amplifier

Technical Data

MSA-2111

Features

- **Cascadable 50 Ω Gain Block**
- **Medium Power:**
10 dBm at 900 MHz
- **High Gain:**
16.5 dB Typical at 900 MHz
- **Low Noise Figure:**
3.3 dB Typical at 900 MHz
- **Low Cost Surface Mount Plastic Package**
- **Tape-and-Reel Packaging Option Available⁽¹⁾**

Note:

1. Refer to PACKAGING section "Tape-and-Reel Packaging for Semiconductor Devices."

Description

The MSA-2111 is a low cost silicon bipolar Monolithic Microwave Integrated Circuit (MMIC) housed in a surface mount plastic SOT-143 package. This MMIC is designed for use as a general purpose 50 Ω gain block. Typical applications include narrow and broad band IF and RF amplifiers in commercial and industrial applications.

The MSA-series is fabricated using Agilent's 10 GHz f_T , 25 GHz f_{MAX} , silicon bipolar MMIC process which uses nitride self-alignment, ion implantation, and gold metallization to achieve excellent performance, uniformity and reliability. The use of an external bias resistor for temperature and current stability also allows bias flexibility.

SOT-143 Package

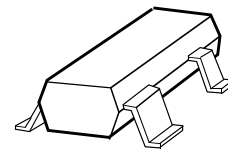

Typical Biasing Configuration

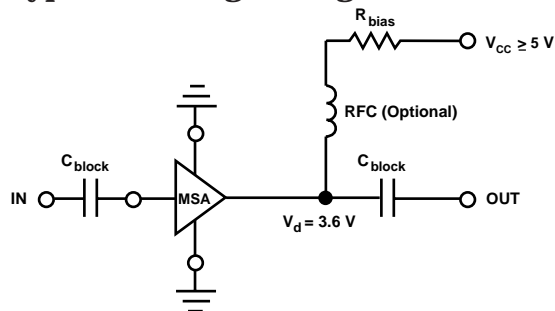

MSA-2111 Absolute Maximum Ratings

Parameter	Absolute Maximum ^[1]
Device Current	40 mA
Power Dissipation ^[2,3]	125 mW
RF Input Power	+13 dBm
Junction Temperature	150°C
Storage Temperature	-65°C to 150°C

Thermal Resistance^[2]:

$$\theta_{jc} = 505^{\circ}\text{C/W}$$

Notes:

1. Permanent damage may occur if any of these limits are exceeded.
2. $T_{\text{CASE}} = 25^{\circ}\text{C}$.
3. Derate at 2.0 mW/°C for $T_{\text{C}} > 85^{\circ}\text{C}$.

Electrical Specifications^[1], $T_{\text{A}} = 25^{\circ}\text{C}$

Symbol	Parameters and Test Conditions: $I_{\text{d}} = 29 \text{ mA}$, $Z_{\text{o}} = 50 \Omega$	Units	Min.	Typ.	Max.
G _P	Power Gain ($ S_{21} ^2$) f = 900 MHz	dB	16.0	17.5	
ΔG_{P}	Gain Flatness f = 0.1 to 0.3 GHz	dB		±0.5	
f _{3 dB}	3 dB Bandwidth	GHz		0.5	
VSWR	Input VSWR f = 0.1 to 2.5 GHz			1.8:1	
	Output VSWR f = 0.1 to 2.5 GHz			1.8:1	
NF	50 Ω Noise Figure f = 900 MHz	dB		3.3	
P _{1 dB}	Output Power at 1 dB Gain Compression f = 900 MHz	dBm		10	
IP ₃	Third Order Intercept Point f = 900 MHz	dBm		20	
t _D	Group Delay f = 900 MHz	psec		158	
V _d	Device Voltage	V	2.9	3.6	4.3
dV/dT	Device Voltage Temperature Coefficient	mV/°C		-8.0	

Notes:

1. The recommended operating current range for this device is 12 to 35 mA. Typical gain performance as a function of current is on the following page.

Part Number Ordering Information

Part Number	No. of Devices	Container
MSA-2111-TR1	3000	7" Reel
MSA-2111-BLK	100	Antistatic Bag

For more information, see "Tape and Reel Packaging for Semiconductor Devices".

MSA-2111 Typical Scattering Parameters ($Z_0 = 50 \Omega$, $T_A = 25^\circ\text{C}$, $I_d = 29 \text{ mA}$)

Freq. GHz	S_{11}		S_{21}			S_{12}			S_{22}		k
	Mag	Ang	dB	Mag	Ang	dB	Mag	Ang	Mag	Ang	
0.1	.28	171	23.0	14.1	167	-26.0	.050	9	.27	177	1.03
0.2	.26	163	22.5	13.4	156	-25.5	.053	18	.27	175	1.03
0.3	.24	156	21.9	12.5	145	-24.9	.057	25	.26	173	1.03
0.4	.21	152	21.2	11.5	136	-24.0	.063	30	.26	171	1.03
0.5	.18	149	20.5	10.6	128	-23.4	.068	35	.24	170	1.03
0.6	.15	148	19.7	9.7	120	-22.6	.074	38	.24	169	1.03
0.7	.13	148	19.0	8.9	114	-21.8	.081	40	.22	169	1.04
0.8	.11	152	18.3	8.2	108	-21.1	.088	42	.21	169	1.04
0.9	.09	158	17.6	7.6	102	-20.4	.095	43	.20	168	1.04
1.0	.07	169	16.9	7.0	98	-19.9	.101	44	.19	169	1.05
1.5	.08	-123	14.0	5.0	79	-17.3	.136	45	.10	179	1.06
2.0	.11	-124	11.8	3.9	63	-15.5	.167	42	.06	-147	1.08
2.5	.15	-167	10.1	3.2	56	-14.3	.193	43	.06	-177	1.10
3.0	.27	158	8.3	2.6	43	-13.5	.211	38	.12	149	1.13
3.5	.38	145	6.8	2.2	32	-13.1	.222	34	.16	145	1.14
4.0	.46	135	5.6	1.9	21	-12.6	.234	30	.17	144	1.14

Typical Performance, $T_A = 25^\circ\text{C}$ (unless otherwise noted)

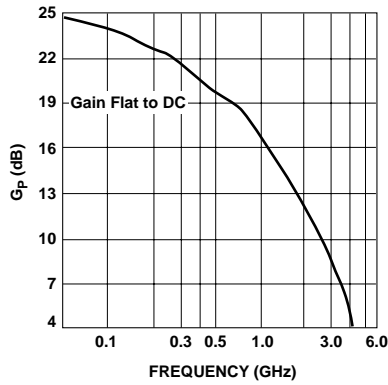

Figure 1. Power Gain vs. Frequency,
 $I_d = 29 \text{ mA}$.

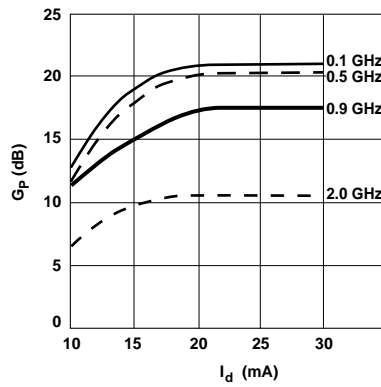

Figure 2. Power Gain vs. Current.

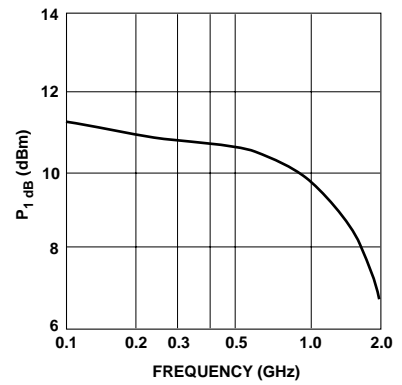

Figure 3. Output Power at 1 dB Gain
Compression vs. Frequency,
 $I_d = 29 \text{ mA}$.

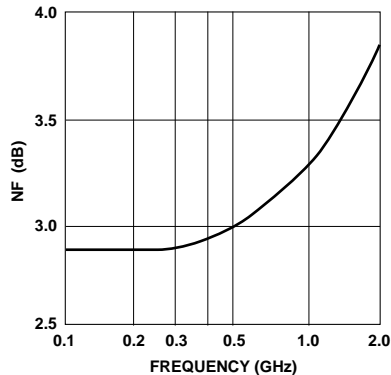
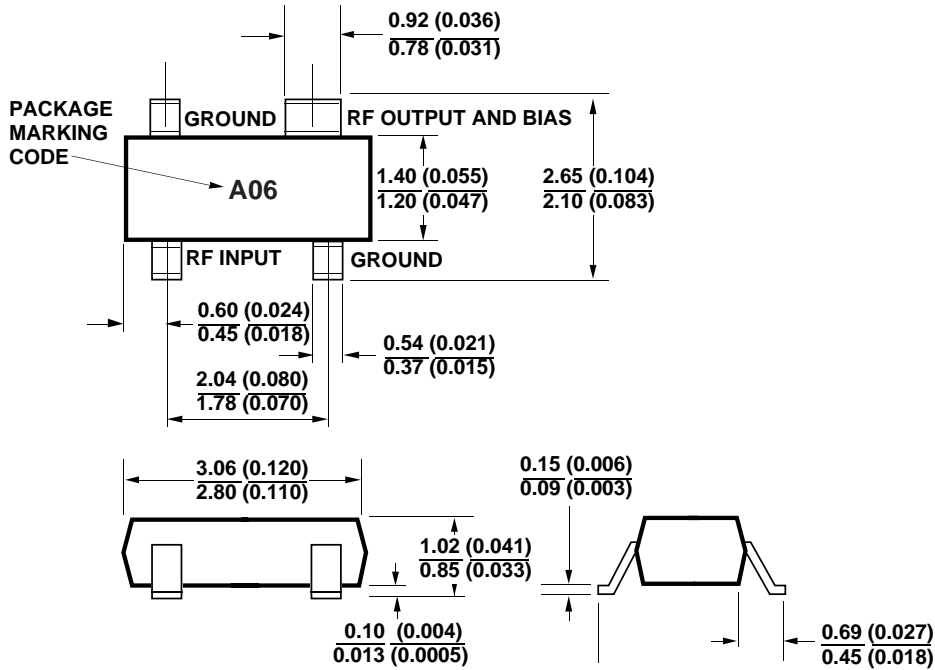

Figure 4. Noise Figure vs. Frequency,
 $I_d = 29 \text{ mA}$.



SOT-143 Package Dimensions



DIMENSIONS ARE IN MILLIMETERS (INCHES)