

1 - Cathode
2 - Anode
Back of Case - Cathode

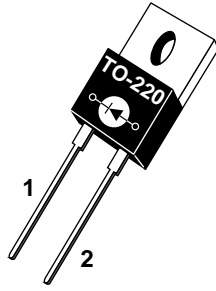

**ADVANCED
POWER
TECHNOLOGY®**
APT15D100K 1000V 15A

ULTRAFAST SOFT RECOVERY RECTIFIER DIODE

| PRODUCT APPLICATIONS | PRODUCT FEATURES | PRODUCT BENEFITS |
|--|--|---|
| <ul style="list-style-type: none"> • Anti-Parallel Diode <ul style="list-style-type: none"> -Switchmode Power Supply -Inverters • Free Wheeling Diode <ul style="list-style-type: none"> -Motor Controllers -Converters • Snubber Diode • Uninterruptible Power Supply (UPS) • Induction Heating • High Speed Rectifiers | <ul style="list-style-type: none"> • Ultrafast Recovery Times • Soft Recovery Characteristics • Popular TO-220 Package • Low Forward Voltage • High Blocking Voltage • Low Leakage Current | <ul style="list-style-type: none"> • Low Losses • Low Noise Switching • Cooler Operation • Higher Reliability Systems • Increased System Power Density |

MAXIMUM RATINGS

All Ratings: $T_C = 25^\circ\text{C}$ unless otherwise specified.

| Symbol | Characteristic / Test Conditions | APT15D100K | UNIT |
|----------------|--|------------|------------------|
| V_R | Maximum D.C. Reverse Voltage | 1000 | Volts |
| V_{RRM} | Maximum Peak Repetitive Reverse Voltage | | |
| V_{RWM} | Maximum Working Peak Reverse Voltage | | |
| $I_F(AV)$ | Maximum Average Forward Current ($T_C = 90^\circ\text{C}$, Duty Cycle = 0.5) | 15 | Amps |
| $I_F(RMS)$ | RMS Forward Current | 25 | |
| I_{FSM} | Non-Repetitive Forward Surge Current ($T_J = 45^\circ\text{C}$, 8.3ms) | 80 | |
| T_J, T_{STG} | Operating and Storage Temperature Range | -55 to 150 | $^\circ\text{C}$ |
| T_L | Lead Temperature: 0.063" from Case for 10 Sec. | 300 | |

STATIC ELECTRICAL CHARACTERISTICS

| Symbol | Characteristic / Test Conditions | MIN | TYP | MAX | UNIT |
|----------|--|--|-----|-----|---------------|
| V_F | Maximum Forward Voltage | $I_F = 15\text{A}$ | | 2.3 | Volts |
| | | $I_F = 30\text{A}$ | | 2.4 | |
| | | $I_F = 15\text{A}, T_J = 150^\circ\text{C}$ | | 1.9 | |
| I_{RM} | Maximum Reverse Leakage Current | $V_R = V_R \text{ Rated}$ | | 250 | μA |
| | | $V_R = V_R \text{ Rated}, T_J = 125^\circ\text{C}$ | | 500 | |
| C_T | Junction Capacitance, $V_R = 200\text{V}$ | | 12 | | pF |
| L_S | Series Inductance (Lead to Lead 5mm from Base) | | 10 | | nH |

USA
405 S.W. Columbia Street
EUROPE
Avenue J.F. Kennedy Bât B4 Parc Cadéra Nord

APT Website - <http://www.advancedpower.com>

Bend, Oregon 97702-1035 Phone: (541) 382-8028 FAX: (541) 388-0364
F-33700 Merignac - France Phone: (33) 557 92 15 15 FAX: (33) 556 47 97 61

DYNAMIC CHARACTERISTICS

APT15D100K

| Symbol | Characteristic | MIN | TYP | MAX | UNIT |
|------------|---|-----|-----|-----|------------|
| t_{rr1} | Reverse Recovery Time, $I_F = 1.0A$, $di_F/dt = -15A/\mu s$, $V_R = 30V$, $T_J = 25^\circ C$ | | 60 | 75 | ns |
| t_{rr2} | Reverse Recovery Time | | 60 | | |
| t_{rr3} | $I_F = 15A$, $di_F/dt = -100A/\mu s$, $V_R = 540V$ | | 120 | | |
| t_{fr1} | Forward Recovery Time | | 180 | | |
| t_{fr2} | $I_F = 15A$, $di_F/dt = 100A/\mu s$, $V_R = 540V$ | | 180 | | |
| I_{RRM1} | Reverse Recovery Current | | 3.8 | 7 | Amps |
| I_{RRM2} | $I_F = 15A$, $di_F/dt = -100A/\mu s$, $V_R = 540V$ | | 4.5 | 9 | |
| Q_{rr1} | Recovery Charge | | 114 | | nC |
| Q_{rr2} | $I_F = 15A$, $di_F/dt = -100A/\mu s$, $V_R = 540V$ | | 270 | | |
| V_{fr1} | Forward Recovery Voltage | | 5.8 | | Volts |
| V_{fr2} | $I_F = 15A$, $di_F/dt = 100A/\mu s$, $V_R = 540V$ | | 5.8 | | |
| diM/dt | Rate of Fall of Recovery Current | | 100 | | A/ μs |
| | $I_F = 15A$, $di_F/dt = -100A/\mu s$, $V_R = 540V$ (See Figure 10) | | 50 | | |

THERMAL AND MECHANICAL CHARACTERISTICS

| Symbol | Characteristic / Test Conditions | MIN | TYP | MAX | UNIT |
|-----------------|--|-----|------|-----|--------------|
| $R_{\theta JC}$ | Junction-to-Case Thermal Resistance | | | 1.7 | $^\circ C/W$ |
| $R_{\theta JA}$ | Junction-to-Ambient Thermal Resistance | | | 80 | |
| W_T | Package Weight | | 0.07 | | oz |
| | | | 1.9 | | gm |
| Torque | Maximum Mounting Torque (Screw Type = 6-32 or 3.5mm Machine) | | | 6.4 | lb•in |
| | | | | 0.7 | N•m |

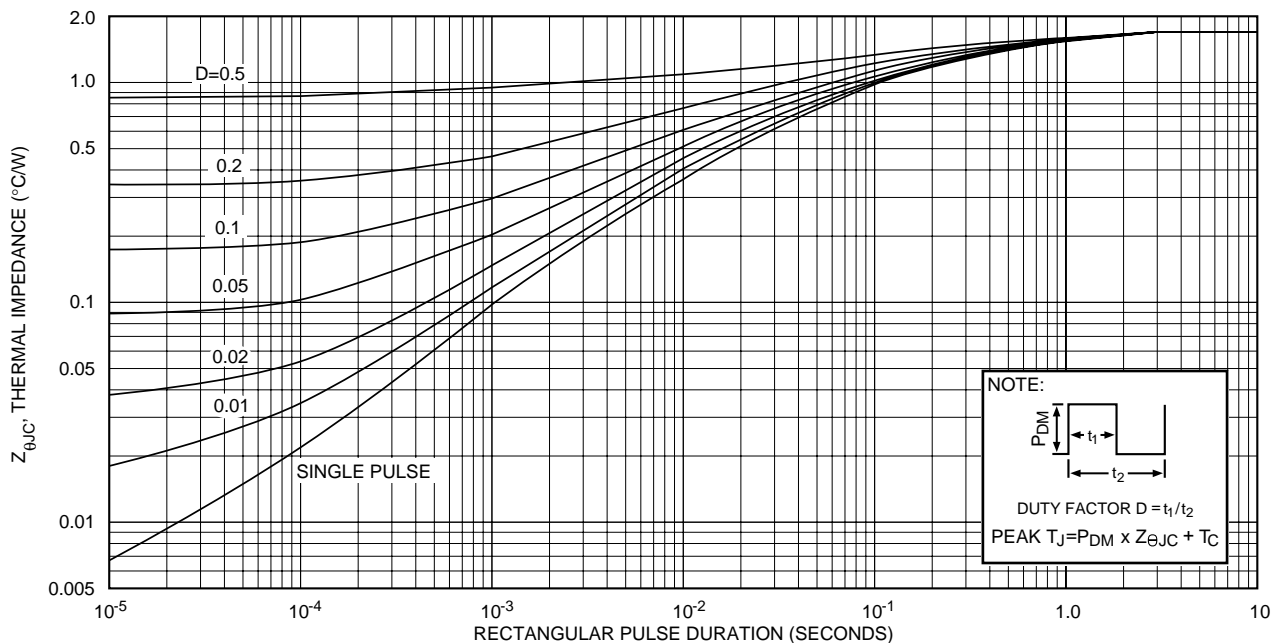

APT15D100K

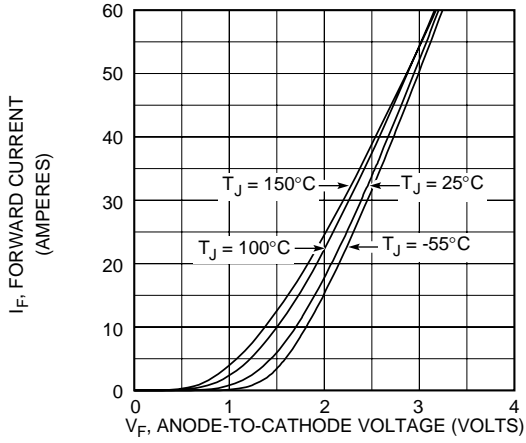

Figure 2, Forward Voltage Drop vs Forward Current

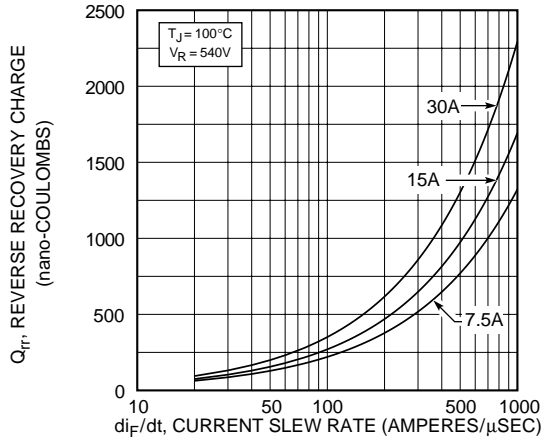

Figure 3, Reverse Recovery Charge vs Current Slew Rate

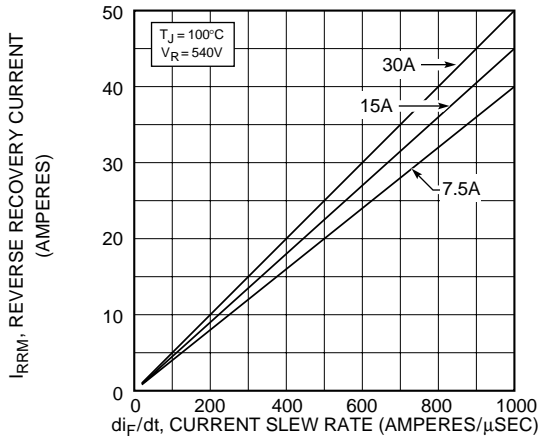

Figure 4, Reverse Recovery Current vs Current Slew Rate

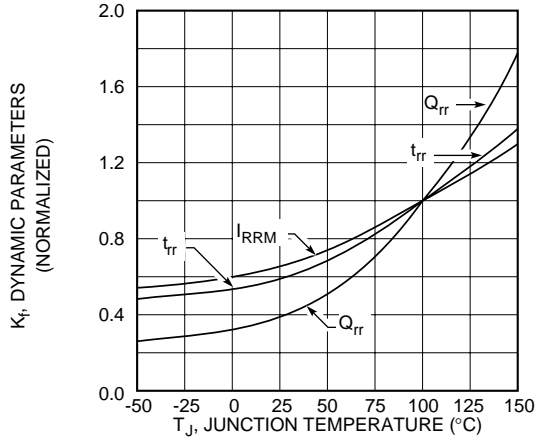

Figure 5, Dynamic Parameters vs Junction Temperature

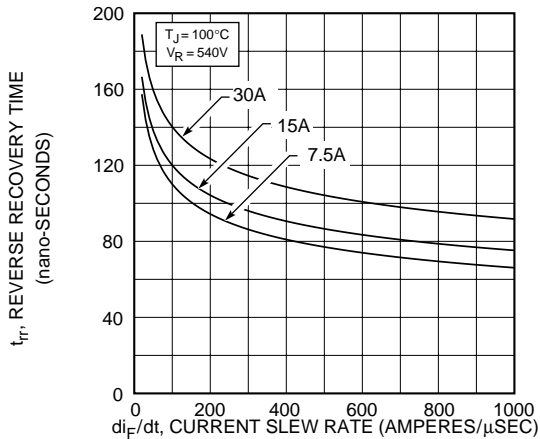

Figure 6, Reverse Recovery Time vs Current Slew Rate

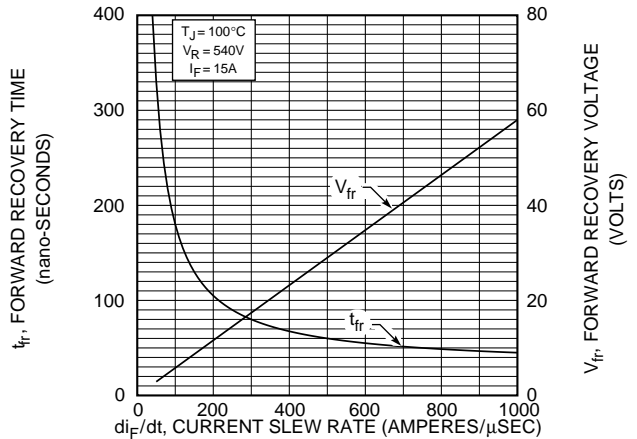

Figure 7, Forward Recovery Voltage/Time vs Current Slew Rate

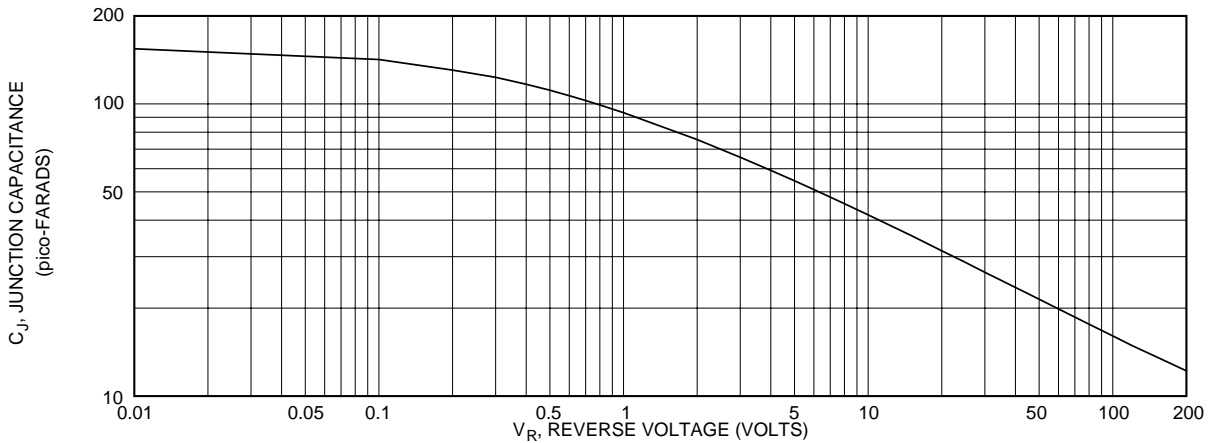

Figure 8, Junction Capacitance vs Reverse Voltage

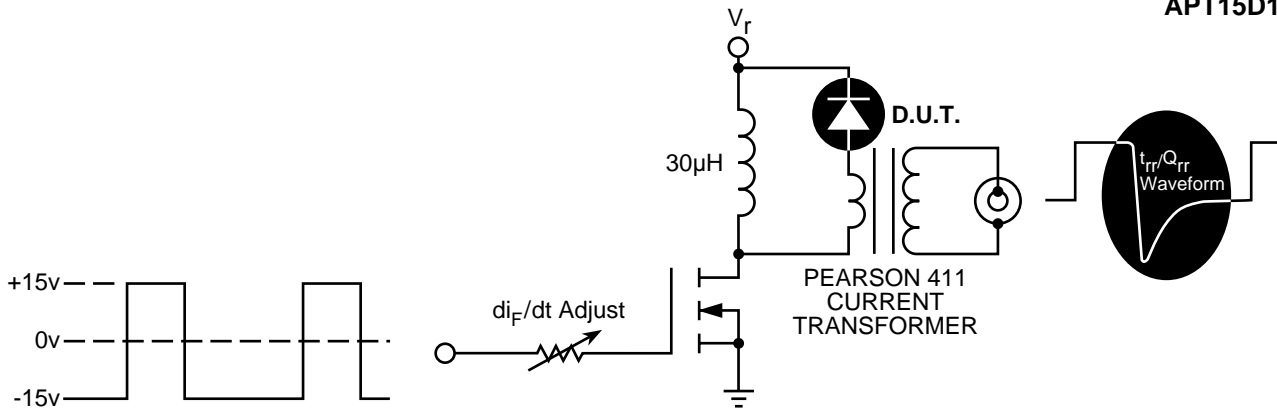

Figure 9, Diode Reverse Recovery Test Circuit and Waveforms

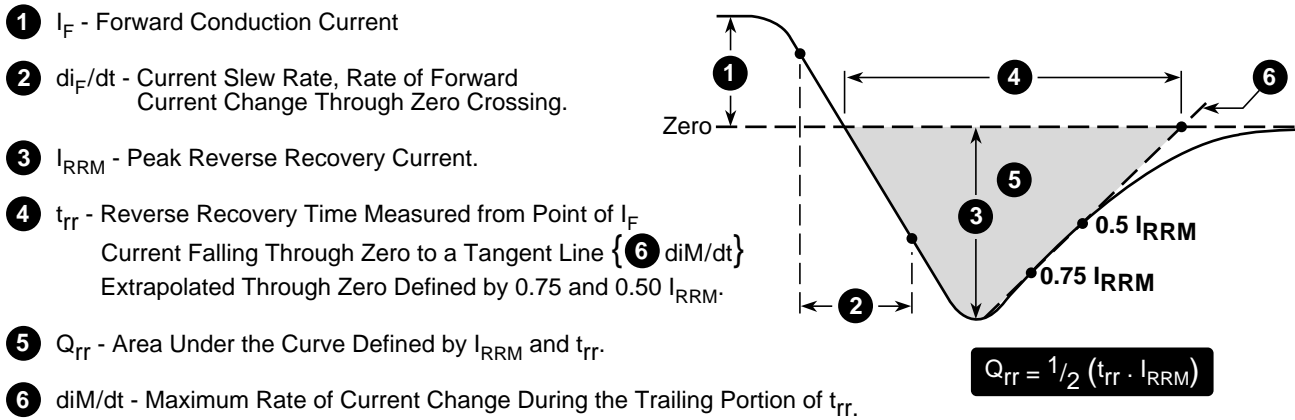

Figure 10, Diode Reverse Recovery Waveform and Definitions

APT Reserves the right to change, without notice, the specifications and information contained herein.

TO-220AB Package Outline

