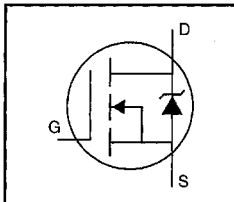


### HEXFET® Power MOSFET

- Dynamic  $dv/dt$  Rating
- Repetitive Avalanche Rated
- Fast Switching
- Ease of Paralleling
- Simple Drive Requirements



$$V_{DSS} = 1000V$$

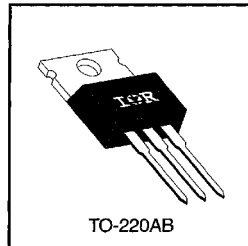
$$R_{DS(on)} = 5.0\Omega$$

$$I_D = 3.1A$$

### Description

Third Generation HEXFETs from International Rectifier provide the designer with the best combination of fast switching, ruggedized device design, low on-resistance and cost-effectiveness.

The TO-220 package is universally preferred for all commercial-industrial applications at power dissipation levels to approximately 50 watts. The low thermal resistance and low package cost of the TO-220 contribute to its wide acceptance throughout the industry.



DATA SHEETS


### Absolute Maximum Ratings

|                           | Parameter                                | Max.                | Units |
|---------------------------|--|---------------------|-------|
| $I_D @ T_C = 25^\circ C$  | Continuous Drain Current, $V_{GS} @ 10V$ | 3.1                 | A     |
| $I_D @ T_C = 100^\circ C$ | Continuous Drain Current, $V_{GS} @ 10V$ | 2.0                 |       |
| $I_{DM}$                  | Pulsed Drain Current ①                   | 12                  |       |
| $P_D @ T_C = 25^\circ C$  | Power Dissipation                        | 125                 | W     |
|                           | Linear Derating Factor                   | 1.0                 | W/°C  |
| $V_{GS}$                  | Gate-to-Source Voltage                   | $\pm 20$            | V     |
| $E_{AS}$                  | Single Pulse Avalanche Energy ②          | 280                 | mJ    |
| $I_{AR}$                  | Avalanche Current ①                      | 3.1                 | A     |
| $E_{AR}$                  | Repetitive Avalanche Energy ①            | 13                  | mJ    |
| $dv/dt$                   | Peak Diode Recovery $dv/dt$ ③            | 1.0                 | V/ns  |
| $T_J$                     | Operating Junction and                   | -55 to +150         | °C    |
| $T_{STG}$                 | Storage Temperature Range                |                     |       |
|                           | Soldering Temperature, for 10 seconds    |                     |       |
|                           | Mounting Torque, 6-32 or M3 screw        | 10 lbf·in (1.1 N·m) |       |


### Thermal Resistance

|                 | Parameter                           | Min. | Typ. | Max. | Units |
|-----------------|-------------------------------------|------|------|------|-------|
| $R_{\theta JC}$ | Junction-to-Case                    | —    | —    | 1.0  | °C/W  |
| $R_{\theta CS}$ | Case-to-Sink, Flat, Greased Surface | —    | 0.50 | —    |       |
| $R_{\theta JA}$ | Junction-to-Ambient                 | —    | —    | 62   |       |

## Electrical Characteristics @ $T_J = 25^\circ\text{C}$ (unless otherwise specified)

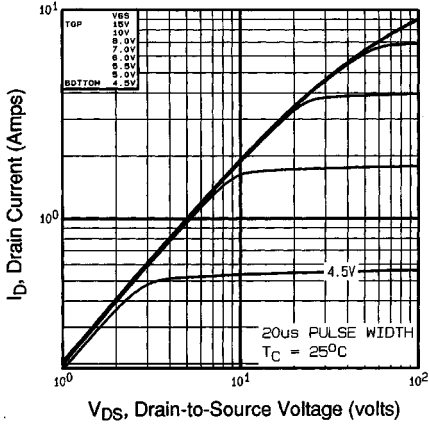
|                                 | Parameter                            | Min. | Typ. | Max. | Units                     | Test Conditions  |
|---------------------------------|--------------------------------------|------|------|------|---------------------------|--|
| $V_{(BR)DSS}$                   | Drain-to-Source Breakdown Voltage    | 1000 | —    | —    | V                         | $V_{GS}=0\text{V}$ , $I_D=250\mu\text{A}$  |
| $\Delta V_{(BR)DSS}/\Delta T_J$ | Breakdown Voltage Temp. Coefficient  | —    | 1.4  | —    | $\text{V}/^\circ\text{C}$ | Reference to $25^\circ\text{C}$ , $I_D=1\text{mA}$                                 |
| $R_{DS(on)}$                    | Static Drain-to-Source On-Resistance | —    | —    | 5.0  | $\Omega$                  | $V_{GS}=10\text{V}$ , $I_D=1.9\text{A}$ ④  |
| $V_{GS(th)}$                    | Gate Threshold Voltage               | 2.0  | —    | 4.0  | V                         | $V_{DS}=V_{GS}$ , $I_D=250\mu\text{A}$   |
| $g_{fs}$                        | Forward Transconductance             | 2.1  | —    | —    | S                         | $V_{DS}=100\text{V}$ , $I_D=1.9\text{A}$ ④   |
| $I_{DSS}$                       | Drain-to-Source Leakage Current      | —    | —    | 100  | $\mu\text{A}$             | $V_{DS}=1000\text{V}$ , $V_{GS}=0\text{V}$   |
|                                 |                                      | —    | —    | 500  |                           | $V_{DS}=800\text{V}$ , $V_{GS}=0\text{V}$ , $T_J=125^\circ\text{C}$                |
| $I_{GSS}$                       | Gate-to-Source Forward Leakage       | —    | —    | 100  | nA                        | $V_{GS}=20\text{V}$  |
|                                 | Gate-to-Source Reverse Leakage       | —    | —    | -100 |                           | $V_{GS}=-20\text{V}$   |
| $Q_g$                           | Total Gate Charge                    | —    | —    | 80   | nC                        | $I_D=3.1\text{A}$  |
| $Q_{gs}$                        | Gate-to-Source Charge                | —    | —    | 10   |                           | $V_{DS}=400\text{V}$   |
| $Q_{gd}$                        | Gate-to-Drain ("Miller") Charge      | —    | —    | 42   |                           | $V_{GS}=10\text{V}$ See Fig. 6 and 13 ④  |
| $t_{d(on)}$                     | Turn-On Delay Time                   | —    | 12   | —    |                           | $V_{DD}=500\text{V}$   |
| $t_r$                           | Rise Time                            | —    | 25   | —    | ns                        | $I_D=3.1\text{A}$  |
| $t_{d(off)}$                    | Turn-Off Delay Time                  | —    | 89   | —    |                           | $R_G=12\Omega$   |
| $t_f$                           | Fall Time                            | —    | 29   | —    |                           | $R_D=170\Omega$ See Figure 10 ④  |
| $L_D$                           | Internal Drain Inductance            | —    | 4.5  | —    | nH                        | Between lead, 6 mm (0.25in.) from package and center of die contact                |
| $L_S$                           | Internal Source Inductance           | —    | 7.5  | —    |                           |  |
| $C_{iss}$                       | Input Capacitance                    | —    | 980  | —    | pF                        | $V_{GS}=0\text{V}$   |
| $C_{oss}$                       | Output Capacitance                   | —    | 140  | —    |                           | $V_{DS}=25\text{V}$  |
| $C_{rss}$                       | Reverse Transfer Capacitance         | —    | 50   | —    |                           | $f=1.0\text{MHz}$ See Figure 5   |

## Source-Drain Ratings and Characteristics

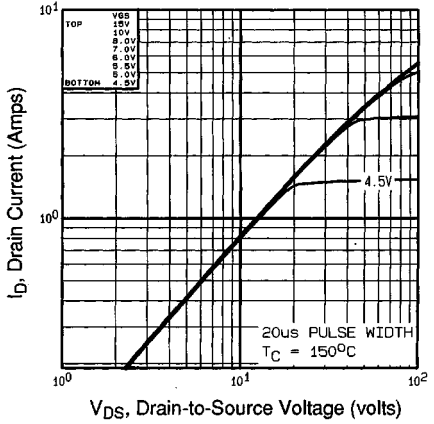
|          | Parameter                              | Min.  | Typ. | Max. | Units         | Test Conditions   |
|----------|--|---|------|------|---------------|---|
| $I_S$    | Continuous Source Current (Body Diode) | —   | —    | 3.1  | A             | MOSFET symbol showing the integral reverse p-n junction diode.  |
| $I_{SM}$ | Pulsed Source Current (Body Diode) ①   | —   | —    | 12   |               |   |
| $V_{SD}$ | Diode Forward Voltage                  | —   | —    | 1.8  | V             | $T_J=25^\circ\text{C}$ , $I_S=3.1\text{A}$ , $V_{GS}=0\text{V}$ ④   |
| $t_{rr}$ | Reverse Recovery Time                  | —   | 410  | 620  | ns            | $T_J=25^\circ\text{C}$ , $I_F=3.1\text{A}$  |
| $Q_{rr}$ | Reverse Recovery Charge                | —   | 1.3  | 2.0  | $\mu\text{C}$ | $di/dt=100\text{A}/\mu\text{s}$ ④   |
| $t_{on}$ | Forward Turn-On Time                   | intrinsic turn-on time is negligible (turn-on is dominated by $L_S+L_D$ ) |      |      |               |   |

### Notes:

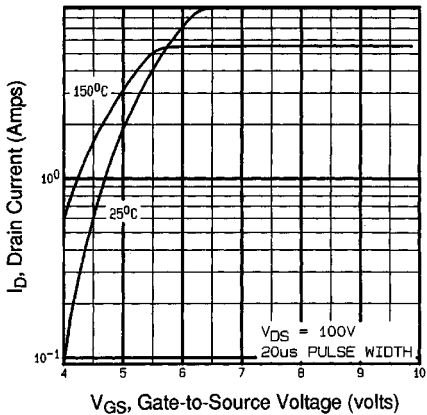
- ① Repetitive rating; pulse width limited by max. junction temperature (See Figure 11)
- ②  $V_{DD}=50\text{V}$ , starting  $T_J=25^\circ\text{C}$ ,  $L=55\text{mH}$ ,  $R_G=25\Omega$ ,  $I_{AS}=3.1\text{A}$  (See Figure 12)
- ③  $I_{SD}\leq 3.1\text{A}$ ,  $di/dt\leq 80\text{A}/\mu\text{s}$ ,  $V_{DD}\leq 600$ ,  $T_J\leq 150^\circ\text{C}$
- ④ Pulse width  $\leq 300\mu\text{s}$ ; duty cycle  $\leq 2\%$ .



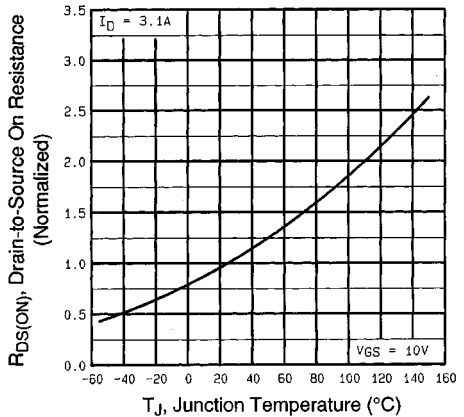
**Fig 1.** Typical Output Characteristics,  
 $T_C=25^\circ\text{C}$



**Fig 2.** Typical Output Characteristics,  
 $T_C=150^\circ\text{C}$

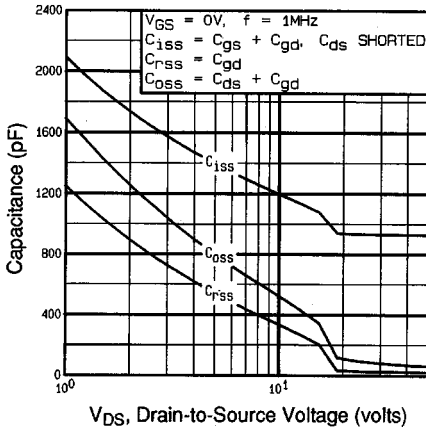


**Fig 3.** Typical Transfer Characteristics

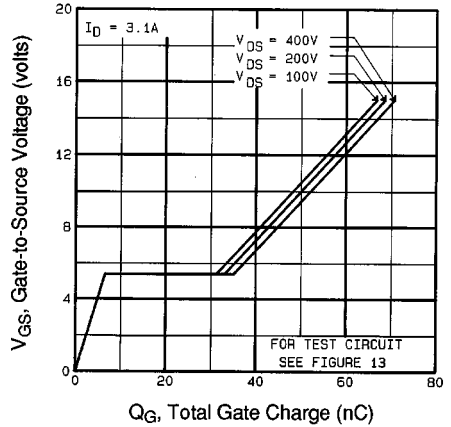


**Fig 4.** Normalized On-Resistance  
Vs. Temperature

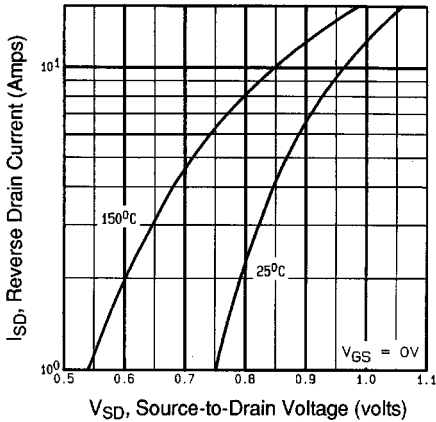
DATA SHEETS



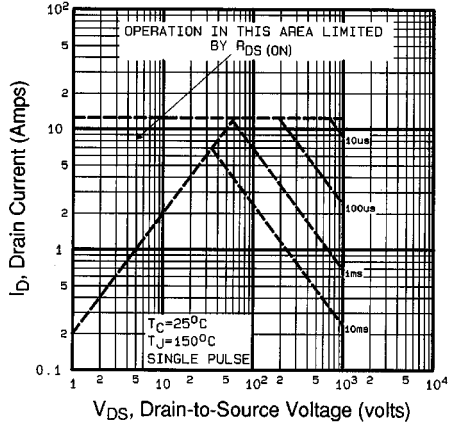
**Fig 5.** Typical Capacitance Vs. Drain-to-Source Voltage



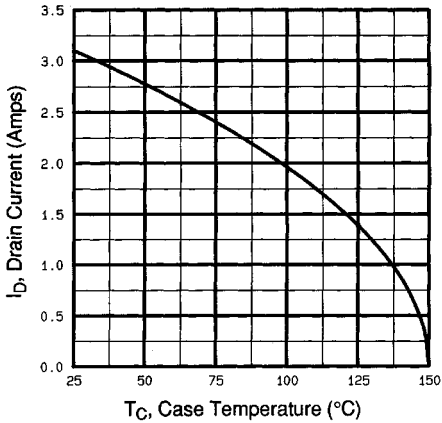
**Fig 6.** Typical Gate Charge Vs. Gate-to-Source Voltage



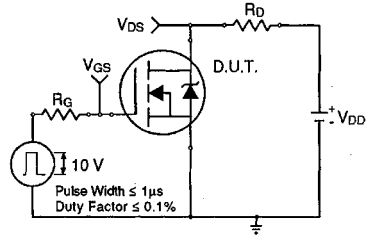
**Fig 7.** Typical Source-Drain Diode Forward Voltage



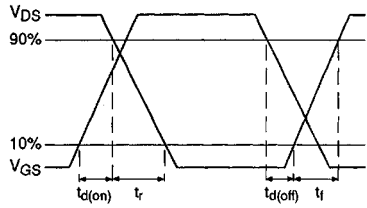
**Fig 8.** Maximum Safe Operating Area



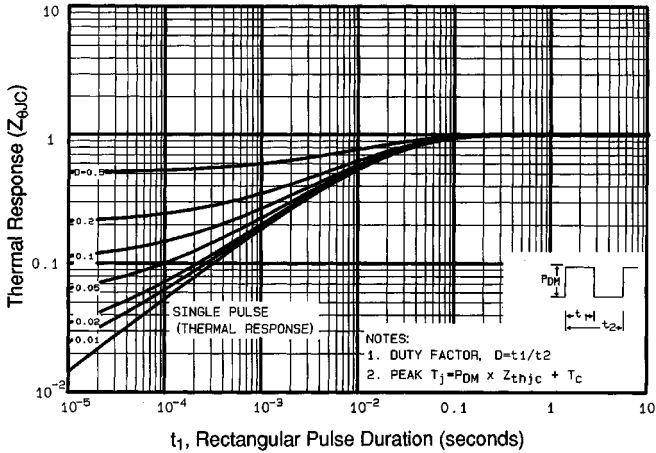
**Fig 9.** Maximum Drain Current Vs. Case Temperature



**Fig 10a.** Switching Time Test Circuit

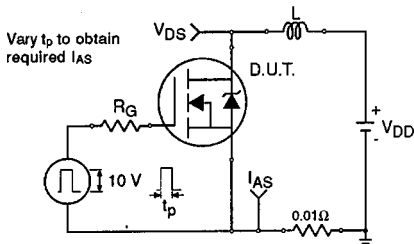


**Fig 10b.** Switching Time Waveforms

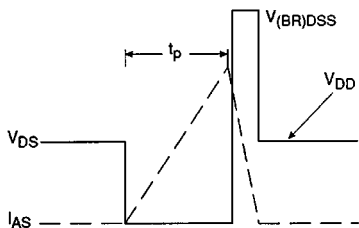


**Fig 11.** Maximum Effective Transient Thermal Impedance, Junction-to-Case

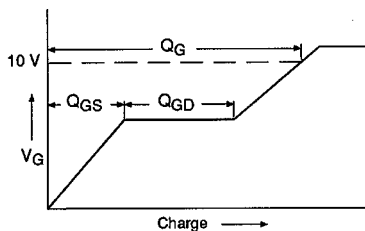
DATA SHEETS



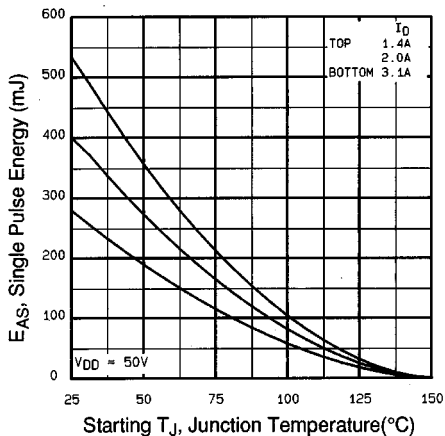
**Fig 12a.** Unclamped Inductive Test Circuit



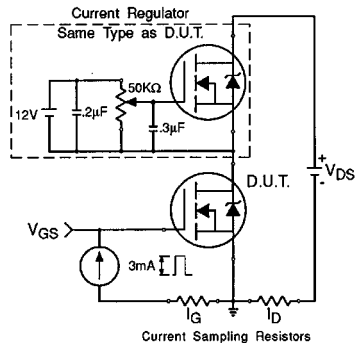
**Fig 12b.** Unclamped Inductive Waveforms



**Fig 13a.** Basic Gate Charge Waveform



**Fig 13c.** Maximum Avalanche Energy Vs. Drain Current



**Fig 13b.** Gate Charge Test Circuit

**Appendix A:** Figure 14, Peak Diode Recovery  $dv/dt$  Test Circuit – See page 1505

**Appendix B:** Package Outline Mechanical Drawing – See page 1509

**Appendix C:** Part Marking Information – See page 1516

**Appendix E:** Optional Leadforms – See page 1525