

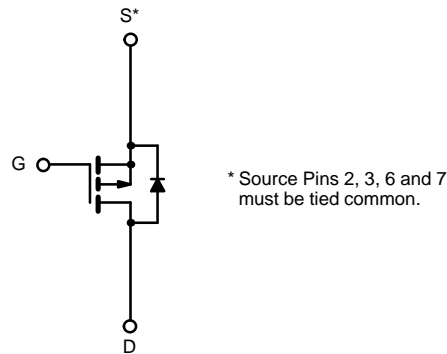

P-Channel 12-V (D-S) MOSFET

PRODUCT SUMMARY		
V_{DS} (V)	$r_{DS(on)}$ (Ω)	I_D (A)
-12	0.011 @ $V_{GS} = -4.5$ V	-10
	0.0135 @ $V_{GS} = -2.5$ V	-9
	0.017 @ $V_{GS} = -1.8$ V	-8

TrenchFET®
Power MOSFETS

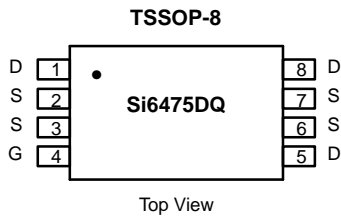

P-Channel MOSFET

ABSOLUTE MAXIMUM RATINGS ($T_A = 25^\circ\text{C}$ UNLESS OTHERWISE NOTED)					
Parameter		Symbol	10 secs	Steady State	Unit
Drain-Source Voltage		V_{DS}	-12		V
Gate-Source Voltage		V_{GS}	± 8		
Continuous Drain Current ($T_J = 150^\circ\text{C}$) ^a	$T_A = 25^\circ\text{C}$	I_D	-10	-7.8	A
	$T_A = 70^\circ\text{C}$		-8	-6.2	
Pulsed Drain Current (10 μs Pulse Width)		I_{DM}	-30		
Continuous Source Current (Diode Conduction) ^a		I_S	-1.5	-0.95	W
Maximum Power Dissipation ^a	$T_A = 25^\circ\text{C}$	P_D	1.75	1.08	
	$T_A = 70^\circ\text{C}$		1.14	0.69	
Operating Junction and Storage Temperature Range		T_J, T_{stg}	-55 to 150		$^\circ\text{C}$

THERMAL RESISTANCE RATINGS					
Parameter		Symbol	Typical	Maximum	Unit
Maximum Junction-to-Ambient ^a	$t \leq 10$ sec	R_{thJA}	55	70	$^\circ\text{C/W}$
	Steady State		95	115	
Maximum Junction-to-Foot (Drain)	Steady State	R_{thJF}	35	45	

Notes

a. Surface Mounted on 1" x 1" FR4 Board.

SPECIFICATIONS (T_J = 25 °C UNLESS OTHERWISE NOTED)

Parameter	Symbol	Test Condition	Min	Typ	Max	Unit
Static						
Gate Threshold Voltage	V _{GS(th)}	V _{DS} = V _{GS} , I _D = -5 mA	-0.45			V
Gate-Body Leakage	I _{GSS}	V _{DS} = 0 V, V _{GS} = ±8 V			±100	nA
Zero Gate Voltage Drain Current	I _{DSS}	V _{DS} = -9.6 V, V _{GS} = 0 V			-1	μA
		V _{DS} = -9.6 V, V _{GS} = 0 V, T _J = 70 °C			-10	
On-State Drain Current ^a	I _{D(on)}	V _{DS} = -5 V, V _{GS} = -4.5 V	20			A
Drain-Source On-State Resistance ^a	r _{DS(on)}	V _{GS} = -4.5 V, I _D = -10 A		0.009	0.011	Ω
		V _{GS} = -2.5 V, I _D = -9 A		0.011	0.0135	
		V _{GS} = -1.8 V, I _D = -8 A		0.014	0.017	
Forward Transconductance ^a	g _{fs}	V _{DS} = -15 V, I _D = -10 A		50		S
Diode Forward Voltage ^a	V _{SD}	I _S = -1.5 A, V _{GS} = 0 V		-0.68	-1.1	V
Dynamic^b						
Total Gate Charge	Q _g	V _{DS} = -6 V, V _{GS} = -4.5 V, I _D = -10 A		49.5	70	nC
Gate-Source Charge	Q _{gs}			7.7		
Gate-Drain Charge	Q _{gd}			8.5		
Turn-On Delay Time	t _{d(on)}	V _{DD} = -6 V, R _L = 6 Ω I _D ≅ -1 A, V _{GEN} = -4.5 V, R _G = 6 Ω		56	85	ns
Rise Time	t _r			62	100	
Turn-Off Delay Time	t _{d(off)}			300	450	
Fall Time	t _f			185	270	
Source-Drain Reverse Recovery Time	t _{rr}		I _F = -1.5 A, di/dt = 100 A/μs		90	

Notes

- a. Pulse test; pulse width ≤ 300 μs, duty cycle ≤ 2%.
 b. Guaranteed by design, not subject to production testing.

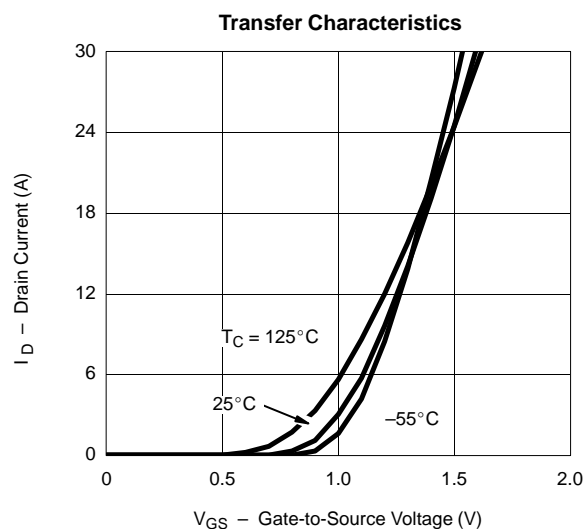
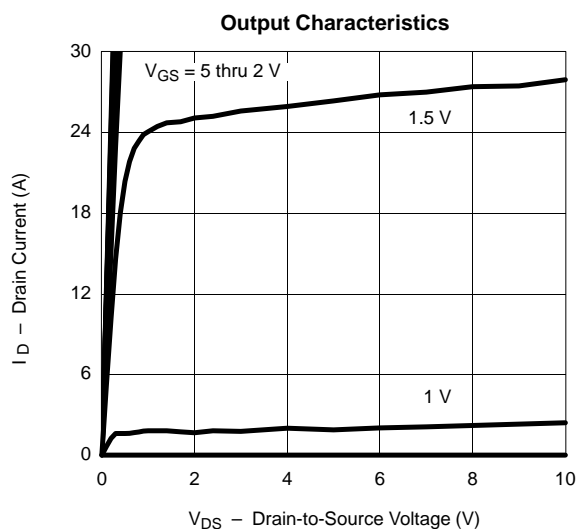
TYPICAL CHARACTERISTICS (25 °C UNLESS NOTED)



TYPICAL CHARACTERISTICS (25°C UNLESS NOTED)

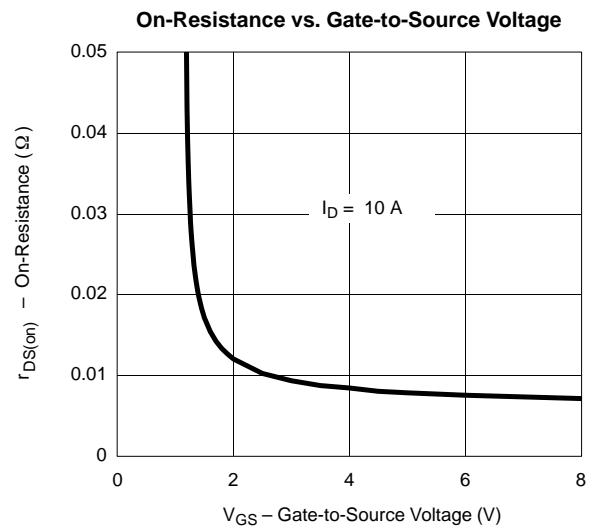
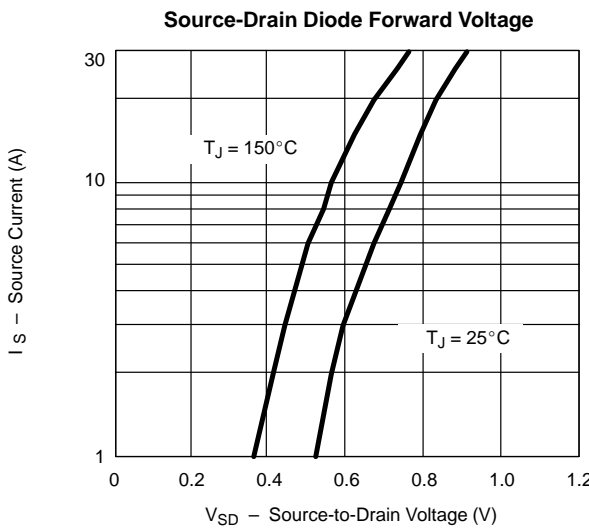
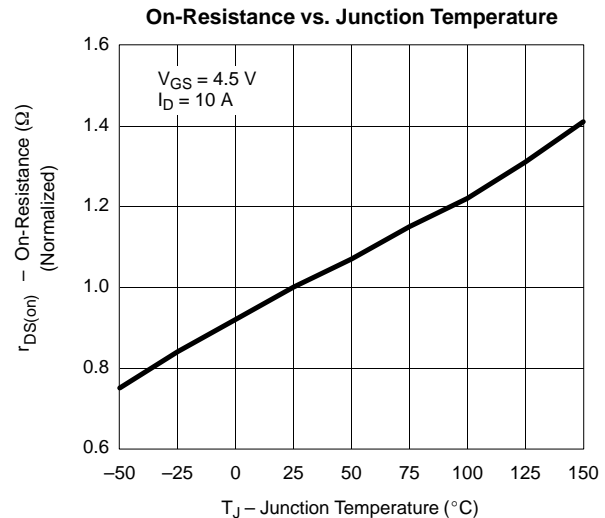
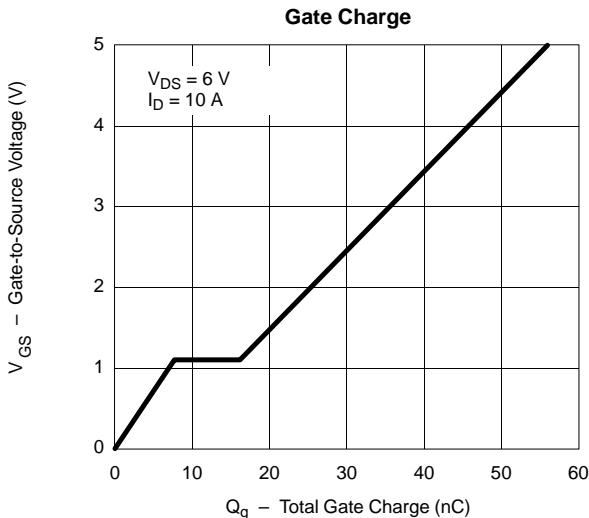
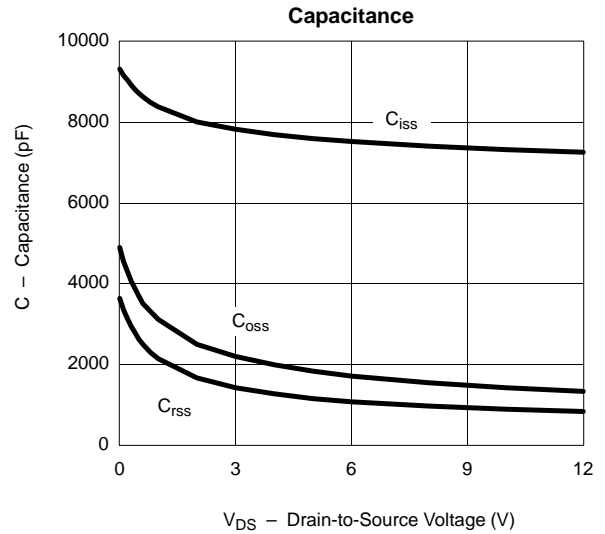
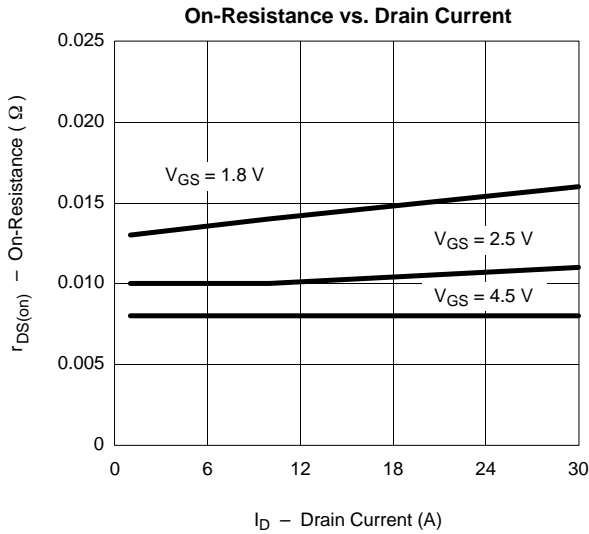



TYPICAL CHARACTERISTICS (25°C UNLESS NOTED)

