

EL - 1KL3 · EL - 1KL5

The EL - 1KL3 and 1KL5 are high - power GaAs IREs mounted in durable, hermetically sealed TO - 18 metal can package, which provides years of reliable performance even under demanding conditions such as use outdoors.

FEATURES

- Narrow beam angle
- Durable
- High reliability in demanding environments

APPLICATIONS

- Optical emitters
- Optical switches
- Encoders
- Smoke sensors

DIMENSIONS

(Unit : mm)

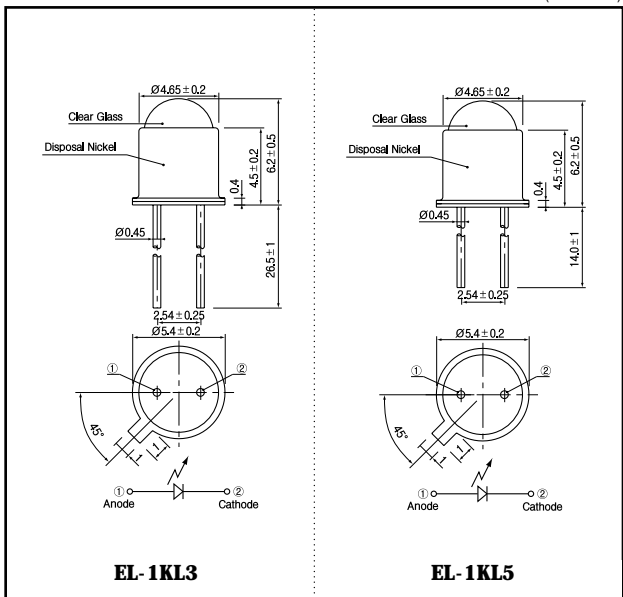

MAXIMUM RATINGS

(Ta=25)

Item	Symbol	Rating	Unit
Reverse voltage	V _R	5	V
Forward current	I _F	100	mA
Pulse forward current *1	I _{FP}	1	A
Power dissipation	P _c	170	mW
Operating temp.	T _{opr.}	- 40 - + 100	
Storage temp.	T _{stg.}	- 55 - + 125	
Soldering temp. *2	T _{sol.}	260	

*1. pulse width : tw 100 µsec, period : T=10msec.

*2. For MAX.5 seconds at the position of 2 mm from the package

ELECTRO-OPTICAL CHARACTERISTICS

(Ta=25)

Item	Symbol	Conditions	EL - 1KL3			EL - 1KL5			Unit.
			Min.	Typ.	Max.	Min.	Typ.	Max.	
Forward voltage	V _f	I _F =100mA	1.35	1.7		1.35	1.7	V	
Reverse current	I _r	V _R =5V			10			µA	
Capacitance	C _t	f=1MHz	25			25		pF	
Radiant intensity	P _o	I _F =100mA	15			10		mW/sr	
Peak emission wavelength	λ _p	I _F =100mA	940			940		nm	
Spectral bandwidth 50%		I _F =100mA	50			50		nm	
Half angle			± 8			± 5		deg.	

Infrared Emitting Diodes(GaAs)

EL - 1KL3 · EL - 1KL5

Power dissipation Vs. Ambient temperature

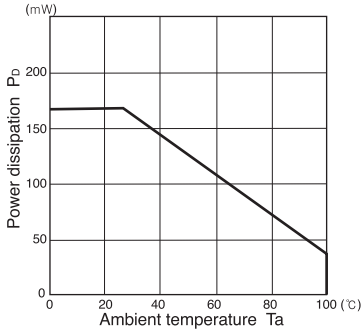

Radiant intensity Vs. Forward current

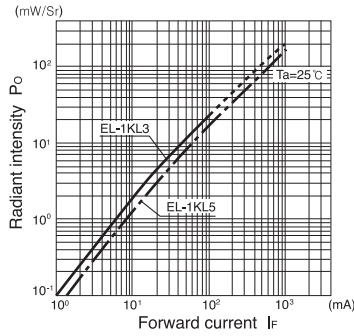

Relative radiant intensity Vs. Ambient temperature

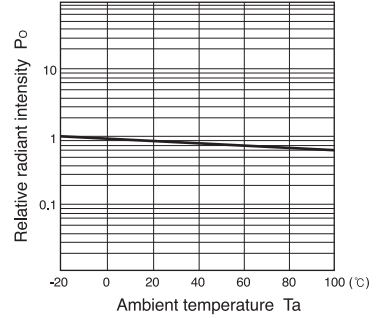

Relative intensity Vs. Wavelength

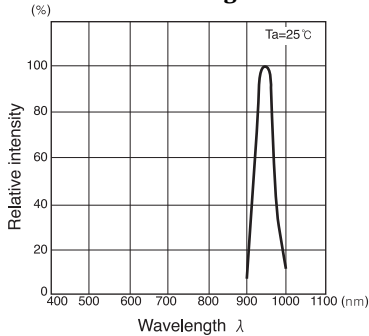

Forward current Vs. Forward voltage

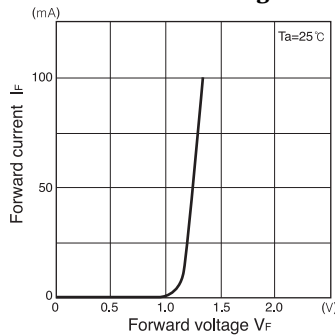

Radiant Pattern

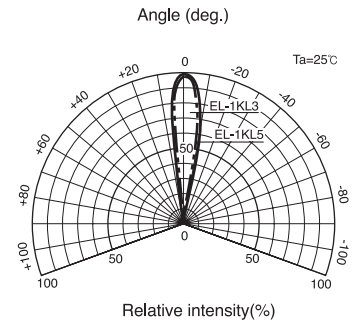

Relative radiant intensity Vs. Distance

