

BL05 - 1211

The BL05 - 1211 is a LED of 650nm wavelength using four elements (AlGaInP). Our original LED processing technology made it possible to increase the electric current density at the emission point. The luminous strength of single light source per unit surface is now more than ten times higher than before.

FEATURES

- High brightness
- The Optical axis match is easy because of red luminance.
- Optical design is easy because of the point light of $\varnothing 50\mu\text{m}$

APPLICATIONS

- Source of light for optical switch , optical fiber , and scanner
- Source of light for optical sensor parallel light
- Source of light for various , precise measurements

DIMENSIONS

(Unit : mm)

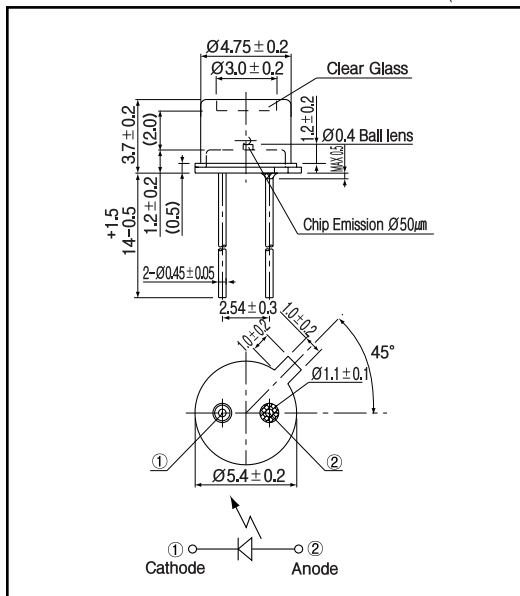

MAXIMUM RATINGS

(Ta=25)

Item	Symbol	Rating	Unit
Reverse voltage	V_R	3	V
Forward current	I_F	20	mA
Power dissipation	P_D	50	mW
Pulse forward current ^{*1}	I_{FP}	150	mA
Operating temp.	$T_{opr.}$	- 30 + 85	
Storage temp.	$T_{stg.}$	- 40 + 100	
Soldering temp. ^{*2}	$T_{sol.}$	260	

*1. pulse width : t_w 10 μsec .period : $T=1\text{msec}$.

*2. For MAX.5 seconds at the position of 2 mm from the package

ELECTRO-OPTICAL CHARACTERISTICS

(Ta=25)

Item	Symbol	Conditions	Min.	Typ.	Max.	Unit.
Forward voltage	V_F	$I_F=20\text{mA}$		2.0	3.0	V
Reverse current	I_R	$V_R=3\text{V}$			10	μA
Radiant intensity	$P_c(\text{W})$	$I_F=20\text{mA}$		0.3		mW
Peak emission wavelength	λ_p	$I_F=20\text{mA}$		650		nm
Spectral bandwidth 50%		$I_F=20\text{mA}$		30		nm
Half angle		$I_F=20\text{mA}$		± 7		deg.

Pin-Point LED(AlGaInP)

BL05 - 1211

Power dissipation Vs. Ambient temperature

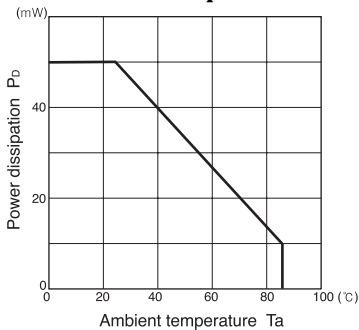

Radiant intensity Vs. Forward current

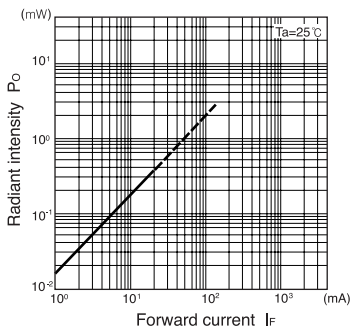

Relative radiant intensity Vs. Ambient temperature

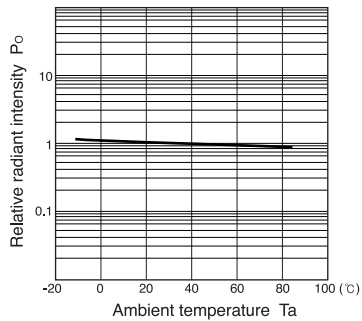

Relative intensity Vs. Wavelength

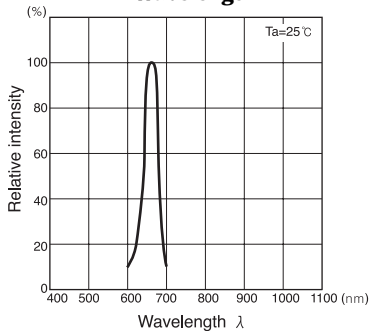

Forward current Vs. Forward voltage

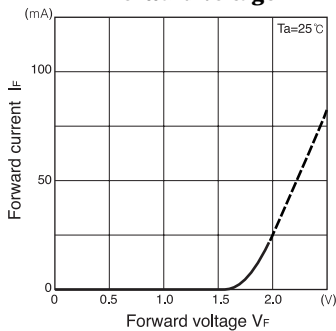

Radiant Pattern

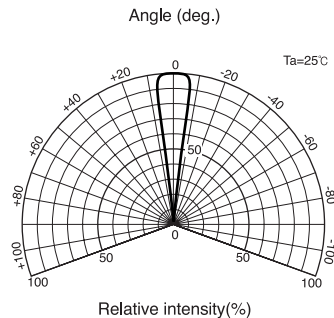

Relative radiant intensity Vs. Distance

