

Low Voltage Electroluminescent Lamp Driver with Regulated Output Voltage

- +2.2V to +4.5V Battery Operation
- DC-to-AC Converter Produces 160V_{pp} typical for EL Display Panels
- Single Resistor Controlled Internal Oscillator
- Low Current Standby Mode
- Internal Feedback Loop Maintains a Constant Regulated EL Lamp Voltage Output

APPLICATIONS

- Pagers
- Cellular Phones
- PDAs



DESCRIPTION

The **SP4405** is a high voltage output DC-AC inverter specifically designed to drive electroluminescent lamps to backlight liquid crystal displays, keypads, and backlit readouts used in battery operated portable equipment. The **SP4405** will operate from a +2.2V to +4.5V battery source. The device features an internal feedback loop that regulates the lamp voltage output to 160V_{pp} (typical) with varying supply voltages to maintain constant EL lamp brightness over the life of the battery. The device also has a low power shutdown mode which draws less than 50nA (typical), ideal for low power portable products. One external inductor is required to generate the high voltage AC output. One external resistor is used to set the internal oscillator frequency. The **SP4405** is ideal for portable applications such as pagers, cellular phones, PDAs, and other portable applications using LCDs in dim or low light environments. The **SP4405** is offered in 8-pin SOIC and 8-pin μ SOIC packages.

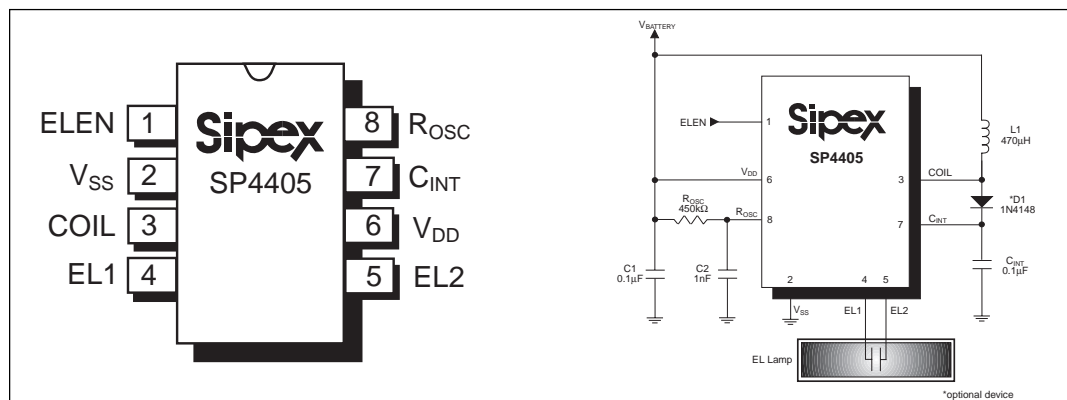

ABSOLUTE MAXIMUM RATINGS

These are stress ratings only and functional operation of the device at these ratings or any other above those indicated in the operation sections of the specifications below is not implied. Exposure to absolute maximum rating conditions for extended periods of time may affect reliability.

Power Supply, $V_{BATTERY}$	7.0V
Input Voltages, ELEN (pin 1).....	-0.5V to ($V_{DD}+0.5V$)
Lamp Outputs.....	200V _{PP}
Operating Temperature.....	-40°C to +85°C
Storage Temperature.....	-65°C to +150°C
Power Dissipation Per Package	
8-pin NSOIC (derate 6.14mW/°C above +70°C).....	500mW
8-pin μ SOIC (derate 4.85mW/°C above +70°C).....	390mW

The information furnished herein by Sipex has been carefully reviewed for accuracy and reliability. Its application or use, however, is solely the responsibility of the user. No responsibility for the use of this information is assumed by Sipex, and this information shall not explicitly or implicitly become part of the terms and conditions of any subsequent sales agreement with Sipex. Specifications are subject to change without prior notice. By the sale or transfer of this information, Sipex assumes no responsibility for any infringement of patents or other rights of third parties which may result from its use. No license or other proprietary rights are granted by implication or otherwise under any patent or patent rights of Sipex Corporation.

SPECIFICATIONS

$V_{BATTERY} = 3.0V$, $L = 470\mu H/3.9\Omega$, $R_{OSC} = 450K\Omega$, $C_{LAMP} = 6.8nF$, $T_{AMB} = 25^\circ C$ and $C_{INT} = 0.1\mu F$ unless otherwise noted; refer to test circuit.

PARAMETER	MIN.	TYP.	MAX.	UNITS	CONDITIONS
Supply Voltage, V_{DD}	2.2	3.0	4.5	V	
Supply Current, $I_{COIL}+I_{DD}$		39 27	55 70	mA	$V_{DD}=3.0V$ $V_{DD}=4.5V$
Coil Voltage, V_{COIL}	V_{DD}		4.5	V	
ELEN Input Voltage, V_{ELEN} LOW: EL off HIGH: EL on	-0.25 $V_{DD}-0.25$	0 V_{DD}	0.25V $V_{DD}+0.25$	V	
Shutdown Current, $I_{SD}=I_{COIL}+I_{DD}$		0.1	1.0	μA	$V_{DD}=4.5V$
INDUCTOR DRIVE					
Coil Frequency, $f_{COIL}=f_{LAMP}\times 128$		48.6		kHz	
Coil Duty Cycle		90		%	
Peak Coil Current, $I_{PK-COIL}$			60	mA	Guaranteed by design.
EL LAMP OUTPUT					
EL Lamp Frequency, f_{LAMP}	320	380	500	Hz	
Peak to Peak Output Voltage	120 150	160	190 200	V_{PP}	$V_{DD}=3.0V$ $V_{DD}=4.5V$

TEST CIRCUIT

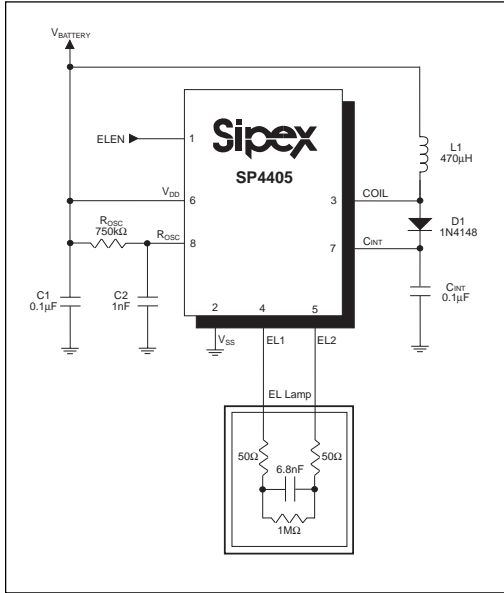

Pin 3 — COIL — Coil. The inductor for the EL lamp is connected from $V_{BATTERY}$ to this input pin.

Pin 4 — EL1 — Eluminescent Lamp. This is a lamp driver output pin to connect to the EL lamp.

Pin 5 — EL2 — Eluminescent Lamp. This is a lamp driver output pin to connect to the EL lamp.

Pin 6 — V_{DD} — Positive Battery Power Supply. Connect such that $+2.2V < V_{DD} < +4.5V$.

Pin 7 — C_{INT} — Integrating Capacitor. Connecting a fast recovery diode from COIL (pin 3) to this input pin increases the light output of the EL lamp. An integrating capacitor (0.1µF) connected from this pin to ground filters out any coil switching spikes or ripple present in the output waveform to the EL lamp.

PIN ASSIGNMENTS

Pin 1 — ELEN — Eluminescent Lamp Enable. When driven HIGH, this input pin enables the EL driver output EL1 and EL2 (pins 4 and 5, respectively) to the EL lamp.

Pin 2 — V_{SS} — Power Supply Common. Connect to the lowest circuit potential, typically ground.

Pin 8 — R_{OSC} — Oscillator Resistor. Connecting a 450kΩ resistor to this input pin sets the frequency of the internal clock.

PINOUT

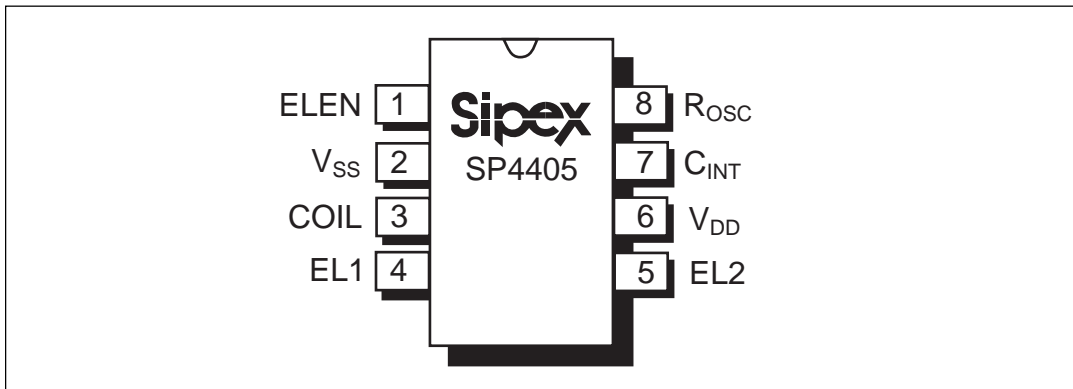

DESCRIPTION

The **SP4405** Electroluminescent Lamp Driver is a low-cost low voltage device ideal for the replacement of LED backlighting designs in keypads, handsets, PDAs and other portable designs. The **SP4405** contains a DC-AC inverter that can produce an AC output of $160V_{PP}$ (typical) from a +2.2V to +4.5V input voltage. An internal feedback loop regulates the lamp voltage output to $160V_{PP}$ (typical) with varying supply voltages to maintain constant EL lamp brightness. An internal block diagram of the **SP4405** can be found in *Figure 1*.

The **SP4405** is built on **Sipex's** dielectrically isolated BiCMOS process that provides the isolation required to separate the high voltage AC signal used to drive the EL lamp from the low voltage logic and signal processing circuitry.

This ensures latch-up free operation in the interface between the low voltage CMOS circuitry and the high voltage bipolar circuitry.

A total of only six external components are required for the standard operation of the **SP4405**: an inductor, a fast recovery diode, three capacitors and a resistor. A diagram of the **SP4405** in a typical application can be found in *Figure 2*.

Electroluminescent Technology

An EL lamp is basically a strip of plastic that is coated with a phosphorous material which emits light (fluoresces) when a high voltage (>40V) which was first applied across it, is removed or reversed. Long periods of DC voltages applied to the material tend to breakdown the material

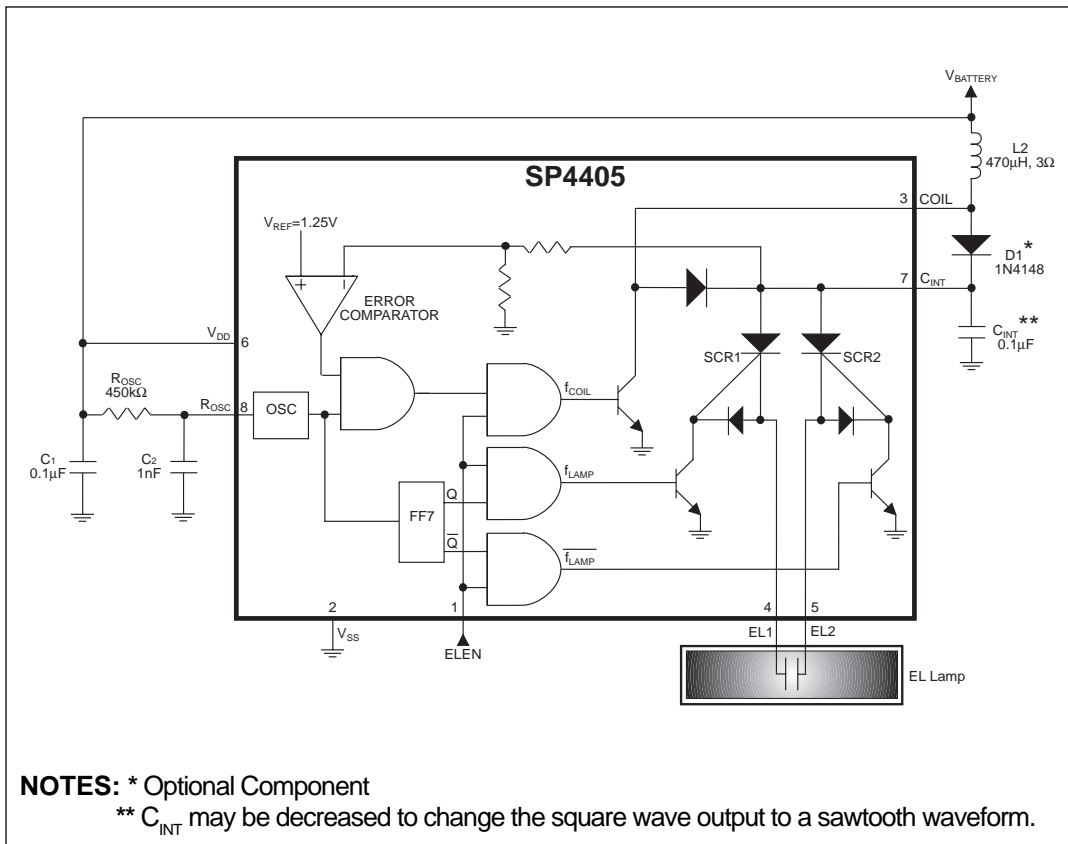

Figure 1. Internal Diagram of the SP4405

and reduce its lifetime. With these considerations in mind, the ideal signal to drive an EL lamp is a high voltage sine wave. Traditional approaches to achieving this type of waveform included discrete circuits incorporating a transformer, transistors, and several resistors and capacitors. This approach is large and bulky and can be difficult to implement in some smaller hand held equipment. **Sipex** now offers low power single chip driver circuits specifically designed to drive small to medium sized electroluminescent panels.

Market Applications

Electroluminescent backlighting is ideal when used with LCD displays, keypads, or other backlit readouts. Its main use is to illuminate displays in dim to dark conditions for momentary periods of time. EL lamps typically consume less power than LEDs or incandescent bulbs making them ideal for battery powered products. Also, EL lamps are able to evenly light an area without creating any undesirable "hot spots" in the display.

THEORY OF OPERATION

The **SP4405** is a DC-AC inverter made up of: 1. The Oscillator/Frequency Divider, 2. The Coil, and 3. The Switched H-bridge Network. Further details of each element follow.

The Oscillator/Frequency Divider

The oscillator provides the **SP4405** with an on-chip clock used to control the coil switch (f_{COIL}) and the H-bridge network (f_{LAMP} and f_{LAMP}). Although the oscillator frequency can be varied to optimize the lamp output, the ratio of f_{COIL}/f_{LAMP} will always equal 128.

Figure 1 shows the oscillator output driving the coil and the output of the oscillator with 7 flip flops driving the lamp. The suggested oscillator frequency is 48.6kHz ($R_{OSC} = 450k\Omega$) for f_{COIL} . The oscillator output is internally divided down by 7 flip flops to create a second internal control signal at 380Hz for f_{LAMP} .

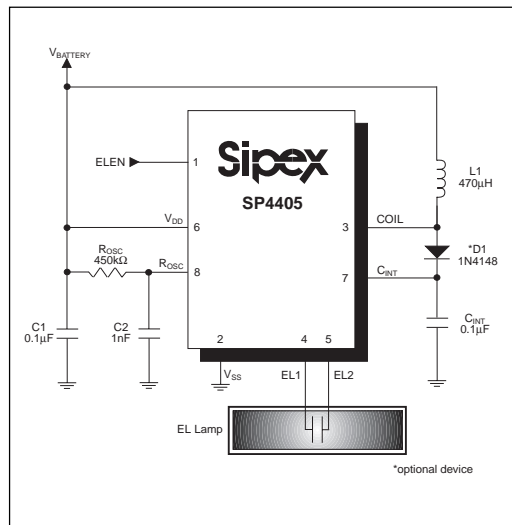

Figure 2. Typical Application Circuit for the SP4405, Set for a Square Wave Output with $C_{INT} = 0.1\mu F$

The Coil

The supply $V_{BATTERY}$ can range from +2.2V to +4.5V. $V_{BATTERY}$ should be chosen such that I_{COIL} does not exceed the maximum coil current specification. The majority of the current goes through the coil and is typically much greater than I_{DD} .

The coil is an external component connected from $V_{BATTERY}$ to pin 3 of the **SP4405**. Energy is stored in the coil according to the equation $E_L = 1/2LI_p^2$ where I_p , to the first approximation, is the product $I_p = (t_{ON}) (V_{BATTERY} - V_{CE})/L$, where t_{ON} is the time it takes for the coil to reach its peak current, V_{CE} is the voltage drop across the internal NPN transistor for f_{COIL} , and L is the inductance of the coil. When the NPN transistor switch is off, the energy is forced through an internal diode which drives the switched H-bridge network. This energy recovery is directly related to the brightness of the EL lamp output. There are many variations among coils; magnetic material differences, winding differences and parasitic capacitances. For suggested coil suppliers, refer to *Page 7*.

The f_{COIL} signal controls a switch that connects the end of the coil at pin 3 to ground or to open circuit. The f_{COIL} signal is a 90% duty cycle signal switching at the oscillator frequency,

35kHz. During the time when the f_{COIL} signal is HIGH, the coil is connected from V_{BATTERY} to ground and a charged magnetic field is created in the coil. When the f_{COIL} signal is LOW, the ground connection is switched open, the field collapses, and the energy in the inductor is forced to flow toward the high voltage H-bridge switches. f_{COIL} will send an array of charge pulses (see *Figure 4*) to the lamp. Each pulse increases the voltage drop across the lamp in discrete steps. As the voltage potential approaches its maximum, the steps become smaller (see *Figure 3*).

The Switched H-Bridge Network

The H-bridge consists of two SCR structures that act as high voltage switches. These two switches control the polarity of how the lamp is charged. The SCR switches are controlled by the f_{LAMP} signal which is the oscillator frequency divided by 128. For a 48.6kHz oscillator, the 7 flip flops will drive $f_{\text{LAMP}} = 380\text{Hz}$.

When the energy from the coil is released, a high voltage spike is created triggering the SCR switches. The direction of current flow is determined by which SCR is enabled. One full cycle of the H-bridge will create 64 voltage steps from ground to 80V (typical) on EL1 and EL2 (pins 4 and 5, respectively) which are 180 degrees out of phase (see *Figure 5*). A differential representation of the output is shown in *Figure 6*.

The feedback loop connects the H-bridge network to the error comparator through an internal resistor network. When the error comparator senses a lamp voltage below regulation ($< 80V_p$ typical), the error comparator enables the oscillator to perform step-up conversions to the lamp output. When the error comparator senses lamp voltages above regulation ($> 80V_p$ typical), it disables the oscillator minimizing power consumption until the lamp voltage drops below regulation. With a varying supply voltage, the EL lamp brightness will appear constant as a direct result of this regulated output voltage.

Fine Tuning Performance

Circuit performance of the **SP4405** can be improved with some of the following suggestions:

Increase EL Lamp Light Output: By connecting a fast recovery diode from COIL (pin 3) to C_{INT} (pin 7), the internal diode of the switched H-bridge network is bypassed resulting in an increase in light output at the EL lamp. We suggest a fast recovery diode, such as the industry standard 1N4148, be used for D1. This circuit connection can be found in *Figure 2*.

Changing the EL Lamp Output Voltage Waveform: Designers can alter the sawtooth output voltage waveform to the EL Lamp. Increasing the capacitance of the integration capacitor C_{INT} will integrate the sawtooth waveform making it appear more like a square wave.

Printed Circuit Board Layout Suggestions: The **SP4405**'s high-frequency operation makes PC layout important for minimizing ground bounce and noise. Keep the IC's GND pin and the ground leads of C1 and C_{INT} in *Figure 2* less than 0.2in (5mm) apart. Also keep the connections to COIL (pin 3) as short as possible. To maximize output power and efficiency and minimize output ripple voltage, use a ground plane and solder the IC's V_{SS} (pin 2) directly to the ground plane.

EL Lamp Driver Design Challenges

There are many variables which can be optimized for specific applications. The amount of light emitted is a function of the voltage applied to the lamp by the inductor, the frequency at which it is applied, the lamp material and the lamp size. **Sipex** supplies characterization charts to aid the designer in selecting the optimum circuit configuration (see *Figures 7 to 25*).

Sipex will perform customer application evaluations, using the customer's actual EL lamp to determine the optimum operating conditions for specific applications. For customers considering an EL backlighting solution for the first time, **Sipex** is able to offer retrofitted solutions to the customer's existing LED or non-backlit product for a thorough electrical and cosmetic evaluation. Please contact your local Sales Representative for **Sipex** or the **Sipex** factory directly to initiate this valued service.

Coil Manufacturers

Hitachi Metals
Material Trading Division
2101 S. Arlington Heights Road,
Suite 116
Arlington Heights, IL 60005-4142
Phone: 1-800-777-8343 Ext. 12
(847) 364-7200 Ext. 12
Fax: (847) 364-7279

Hitachi Metals Ltd. Europe
Immernannstrasse 14-16, 40210
Dusseldorf, Germany
Contact: Gary Loos
Phone: 49-211-16009-0
Fax: 49-211-16009-29

Hitachi Metals Ltd.
Kishimoto Bldg. 2-1, Marunouchi
2-chome, Chiyoda-Ku, Tokyo, Japan
Contact: Mr. Noboru Abe
Phone: 3-3284-4936
Fax: 3-3287-1945

Hitachi Metals Ltd. Singapore
78 Shenton Way #12-01,
Singapore 079120
Contact: Mr. Stan Kaiko
Phone: 222-8077
Fax: 222-5232

Hitachi Metals Ltd. Hong Kong
Room 1107, 11/F., West Wing,
Tsim Sha. Tsui Center 66
Mody Road, Tsimshatsui East,
Kowloon, Hong Kong
Phone: 2724-4188
Fax: 2311-2095

Toko America Inc.
1250 Feehanville Drive
Mt. Prospect, IL, 60056 U.S.A.
Phone: (847) 297-0070
Fax: (847) 699-7864

Toko Inc. Europe
Burgmullerstr. 7, D-40235
Dusseldorf 1, FR Germany
Phone: (0211) 680090
Fax: (0211) 679-9567

Toko Inc. Japan
1-17, Higashi-Yukigaya
2-chome, Ohta-ku,
Tokyo 145 Japan
Phone: 03-3727-1161
Fax: 03-3727-1176

Toko Inc. Singapore
No. 1 Lorong 2. Toa Pavoh.
#03-00, Singapore, 319637
Phone: (255) 4000
Fax: (250) 8134

Toko Inc. Hong Kong
45 Hoi Yuen Road, Yau Lee
Centre, 7th, 8th, & 9th Fl.,
Kwun-Tong Kowloon,
Hong Kong
Phone: 2348131
Fax: 23419570

Sumida Electric Co., LTD.
5999, New Wilke Road,
Suite #110
Rolling Meadows, IL, 60008 U.S.A.
Phone: (847) 956-0666
Fax: (847) 956-0702

Sumida Electric Co., LTD.
4-8, Kanamachi 2-Chrome,
Katsushika-ku, Tokyo 125 Japan
Phone: 03-3607-5111
Fax: 03-3607-5144

Sumida Electric Co., LTD.
Block 15, 996, Bendemeer Road
#04-05 to 06, Singapore 339944
Republic of Singapore
Phone: 2963388
Fax: 2963390

Sumida Electric Co., LTD.
14 Floor, Eastern Center, 1065
King's Road, Quarry Bay,
Hong Kong
Phone: 28806688
Fax: 25659600

Murata
2200 Lake Park Drive, Smyrna
Georgia 30080 U.S.A.
Phone: (770) 436-1300
Fax: (770) 436-3030

Murata European
Holbeinstrasse 21-23, 90441
Numberg, Postfachanschrift 90015
Phone: 011-4991166870
Fax: 011-49116687225

Murata Taiwan Electronics
225 Chung-Chin Road, Taichung,
Taiwan, R.O.C.
Phone: 011 88642914151
Fax: 011 88644252929

Murata Electronics Singapore
200 Yishun Ave. 7, Singapore
2776, Republic of Singapore
Phone: 011 657584233
Fax: 011 657536181

Murata Hong Kong
Room 709-712 Miramar Tower, 1
Kimberly Road, Tsimshatsui,
Kowloon, Hong Kong
Phone: 011-85223763898
Fax: 011-85223755655

Polarizers/transflector Mnfg.

Nitto Denko
Yoshi Shinozuka
Bayside Business Park 48500
Fremont, CA. 94538
Phone: 510 445 5400
Fax: 510 445-5480

Top Polarizer- NPF F1205DU
Bottom - NPF F4225
or (F4205) P3 w/transflector

Transflector Material
Astra Products
Mark Bogin
P.O. Box 479
Baldwin, NJ 11510
Phone (516)-223-7500
Fax (516)-868-2371

EL Lamp manufacturers

Leading Edge Ind. Inc.
11578 Encore Circle
Minnetonka, MN 55343
Phone 1-800-845-6992

Midori Mark Ltd.
1-5 Komagata 2-Chome
Taita-Ku 111-0043 Japan
Phone: 81-03-3848-2011

Luminescent Systems Inc. (LSI)
4 Lucent Drive
Lebanon, NH. 03766
Phone: (603) 643-7766
Fax: (603) 643-5947

NEC Corporation
Yumi Saskai
7-1, Shiba 5 Chome, Minato-ku,
Tokyo 108-01, Japan
Phone: (03) 3798-9572
Fax: (03) 3798-6134

Seiko Precision
Shuzo Abe
1-1, Taihei 4-Chome,
Sumida-ku, Tokyo, 139 Japan
Phone: (03) 5610-7089
Fax: (03) 5610-7177

Gunze Electronics
2113 Wells Branch Parkway
Austin, TX 78728
Phone: (512) 752-1299
Fax: (512) 252-1181

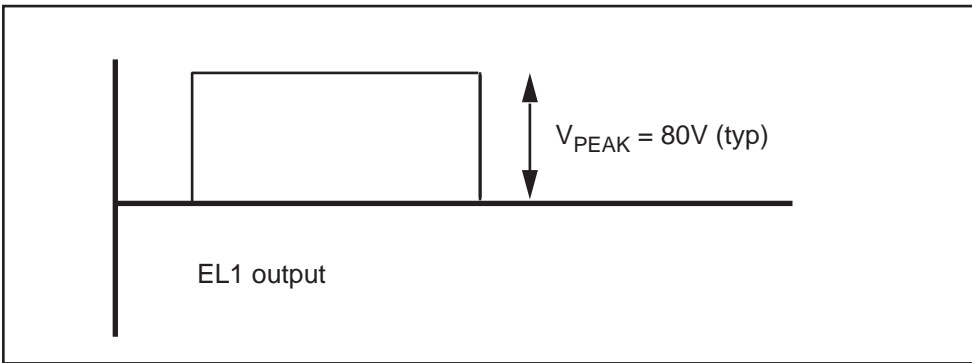

Figure 3. EL Output Voltage in Discrete Steps at EL1 Output

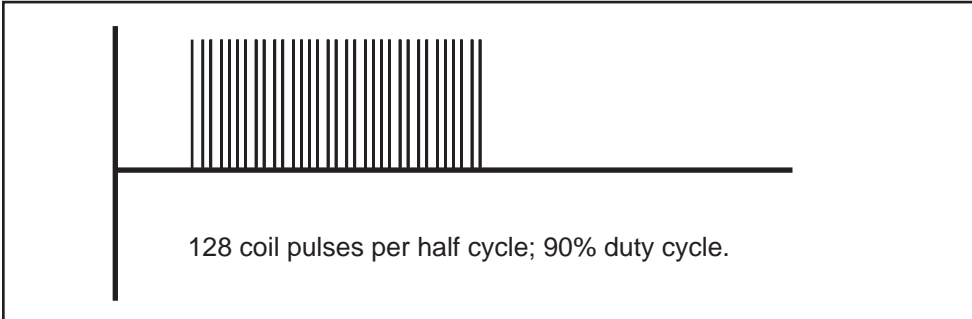

Figure 4. Voltage Pulses Released from the Coil to the EL Driver Circuitry

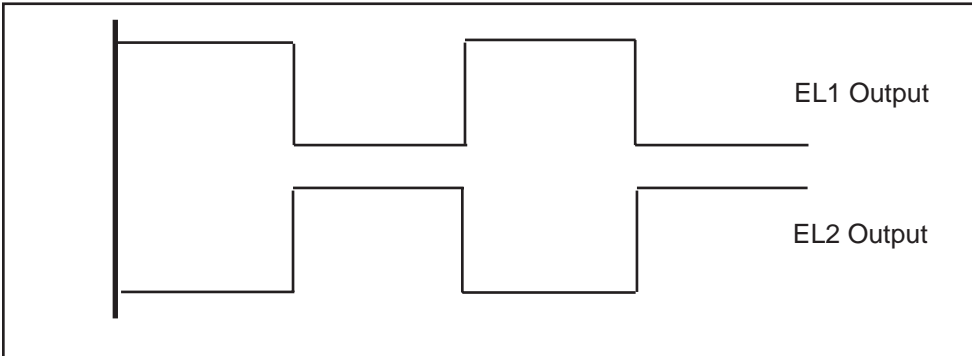

Figure 5. EL Voltage Waveforms from the EL1 and EL2 Outputs

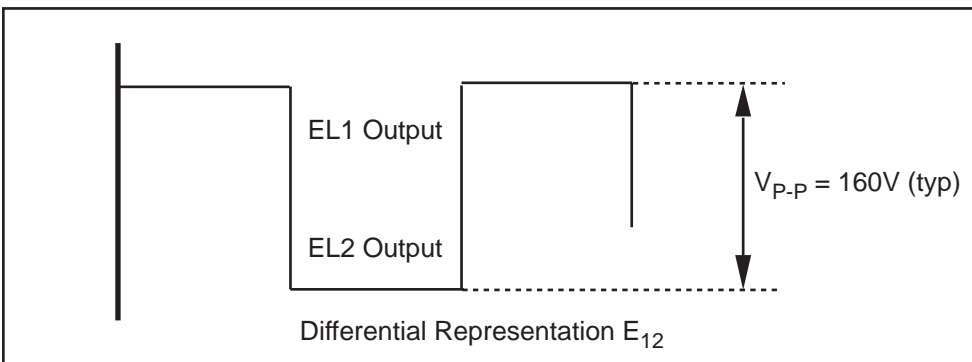

Figure 6. EL Differential Output Waveform of the EL1 and EL2 Outputs

The following performance curves are intended to give the designer a relative scale from which to optimize specific applications. Absolute measurements may vary depending upon the brand of components chosen.

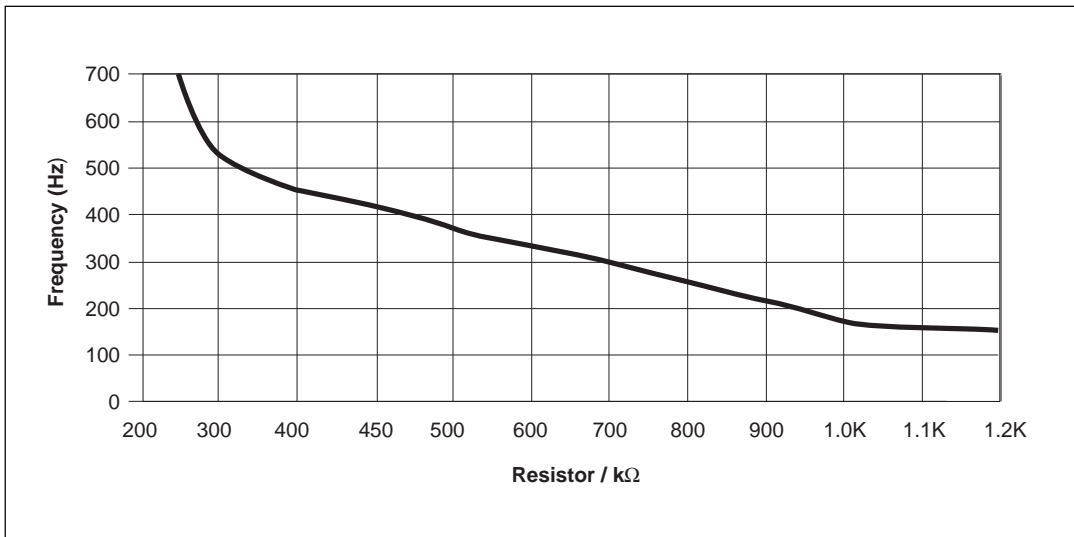

Figure 7. Lamp Frequency vs R_{osc}

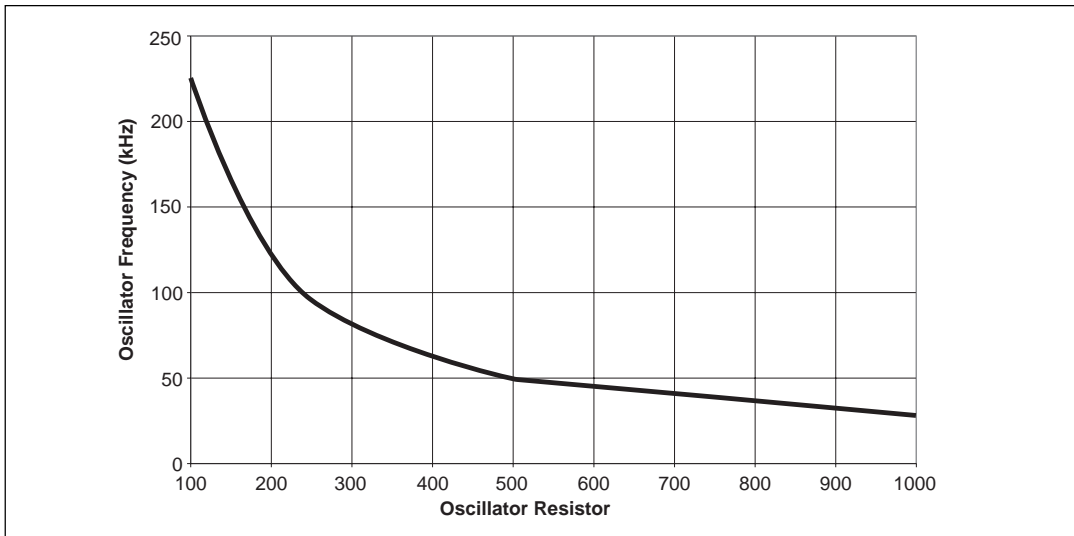

Figure 8. Oscillator Frequency vs R_{osc}

The following performance curves are intended to give the designer a relative scale from which to optimize specific applications. Absolute measurements may vary depending upon the brand of components chosen.

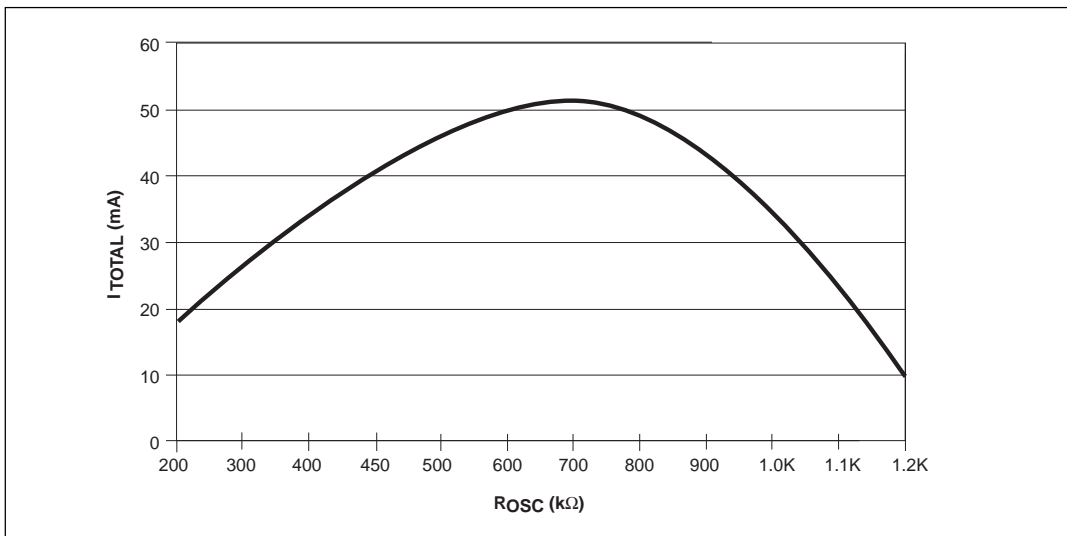

Figure 9. I_{TOTAL} vs R_{OSC} with/without external diode

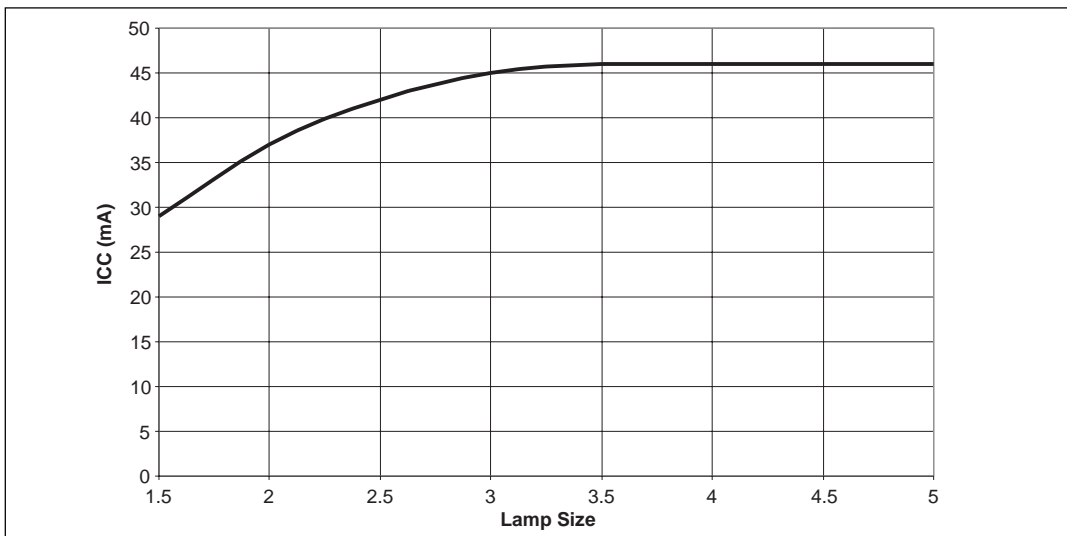

Figure 10. I_{TOTAL} vs Lamp Size

The following performance curves are intended to give the designer a relative scale from which to optimize specific applications. Absolute measurements may vary depending upon the brand of components chosen.

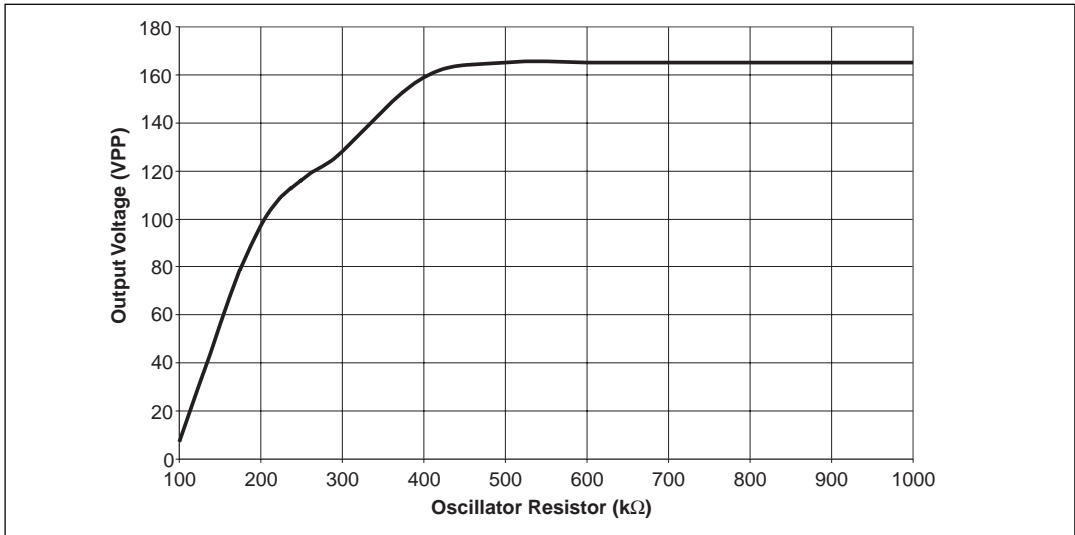

Figure 11. Output Voltage vs R_{osc}

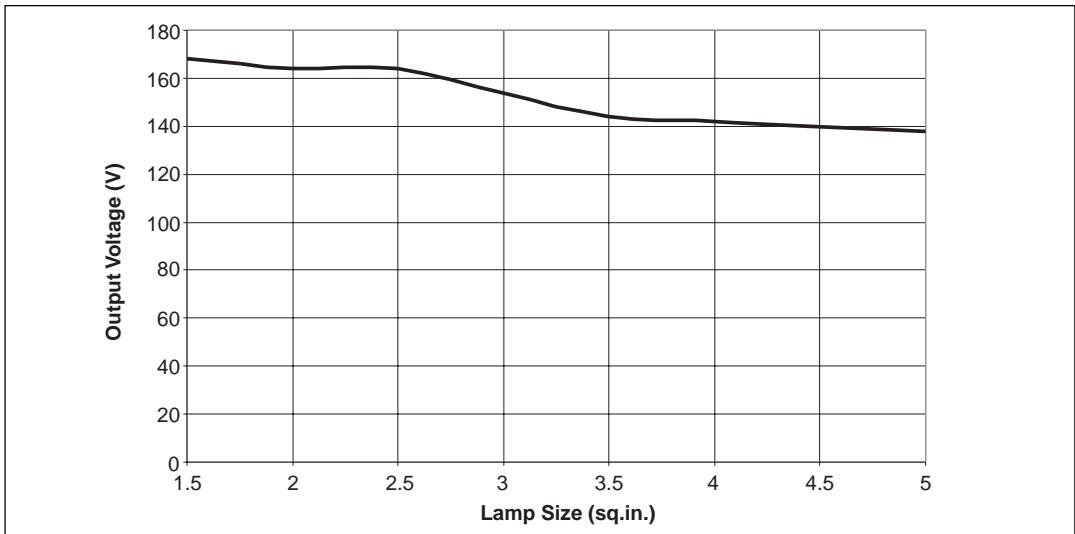

Figure 12. Output Voltage vs Lamp Size (Lamp Capacitance)

The following performance curves are intended to give the designer a relative scale from which to optimize specific applications. Absolute measurements may vary depending upon the brand of components chosen.

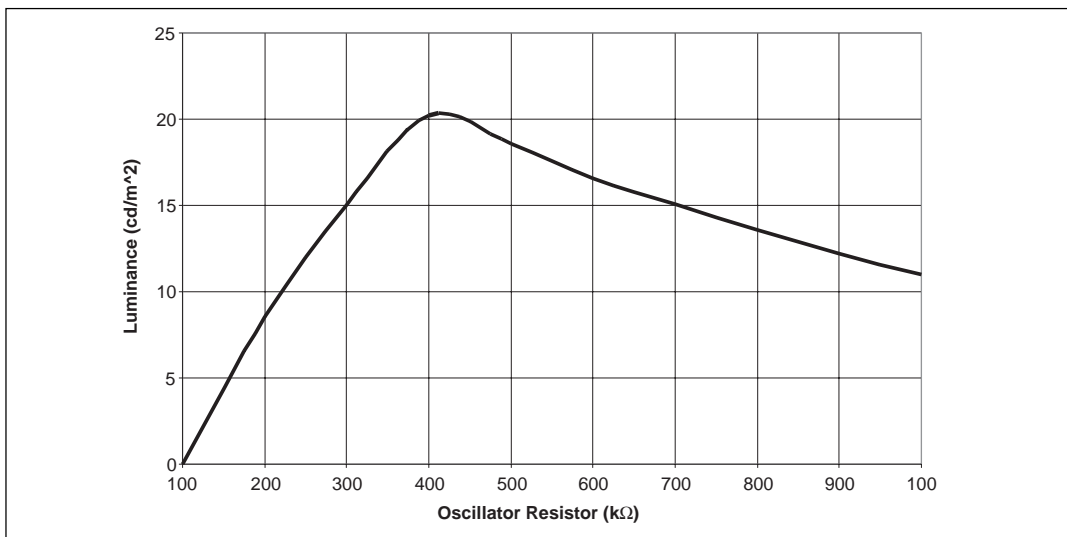

Figure 13. Luminance (cd/m^2) vs R_{osc}

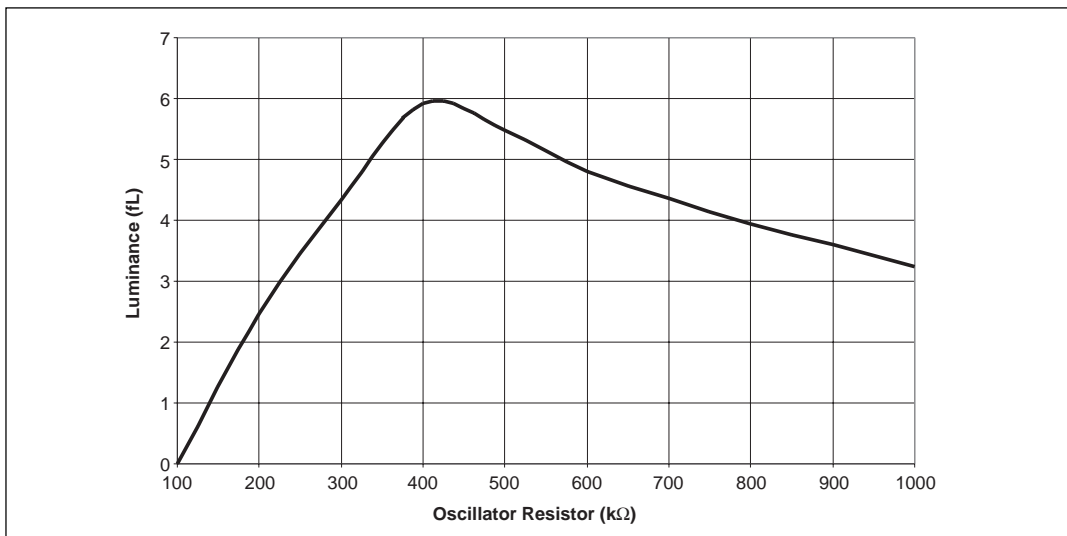

Figure 14. Luminance (fL) vs R_{osc}

The following performance curves are intended to give the designer a relative scale from which to optimize specific applications. Absolute measurements may vary depending upon the brand of components chosen.

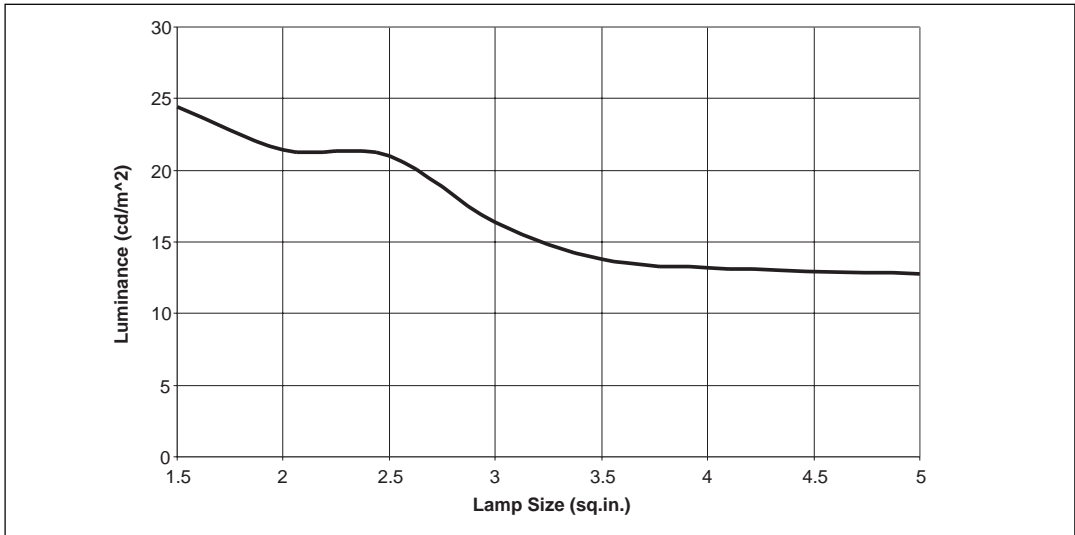

Figure 15.

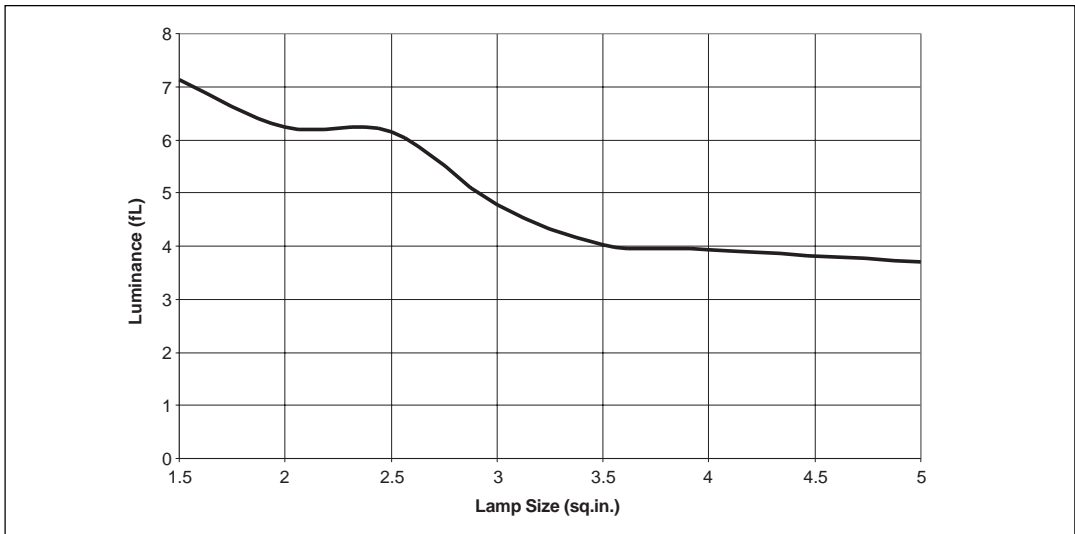

Figure 16.

The following performance curves are intended to give the designer a relative scale from which to optimize specific applications. Absolute measurements may vary depending upon the brand of components chosen.

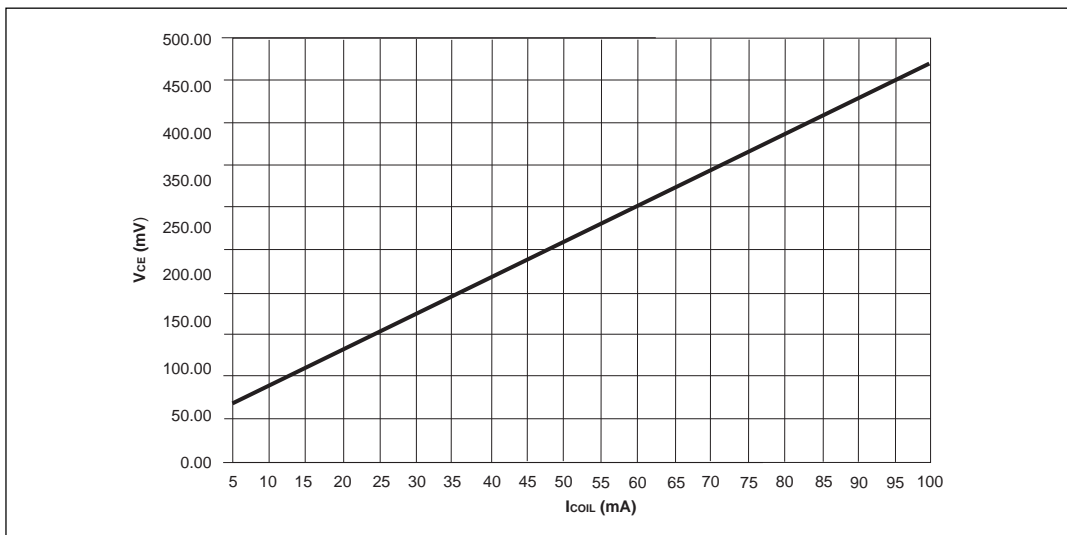

Figure 17. V_{CE} vs Coil Current

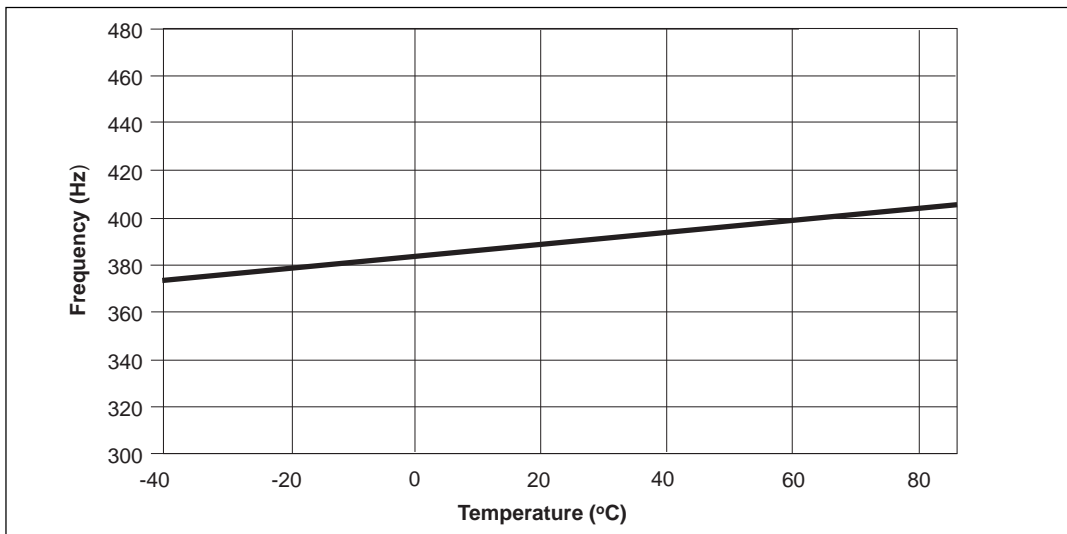

Figure 18. Frequency vs Temperature, $V_{DD} = 2.2V$

The following performance curves are intended to give the designer a relative scale from which to optimize specific applications. Absolute measurements may vary depending upon the brand of components chosen.

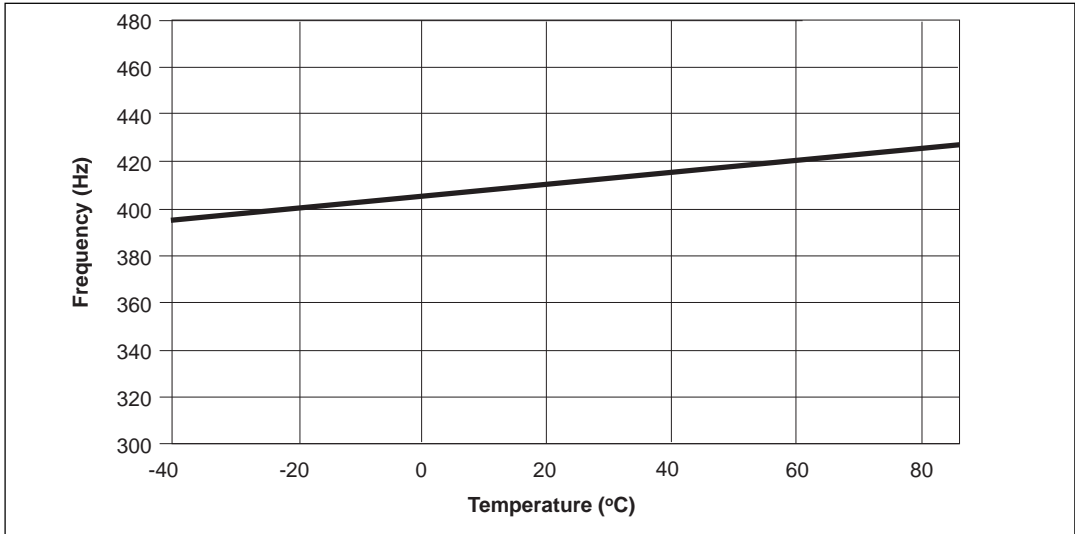

Figure 19. Frequency vs Temperature, $V_{DD} = 3.0V$

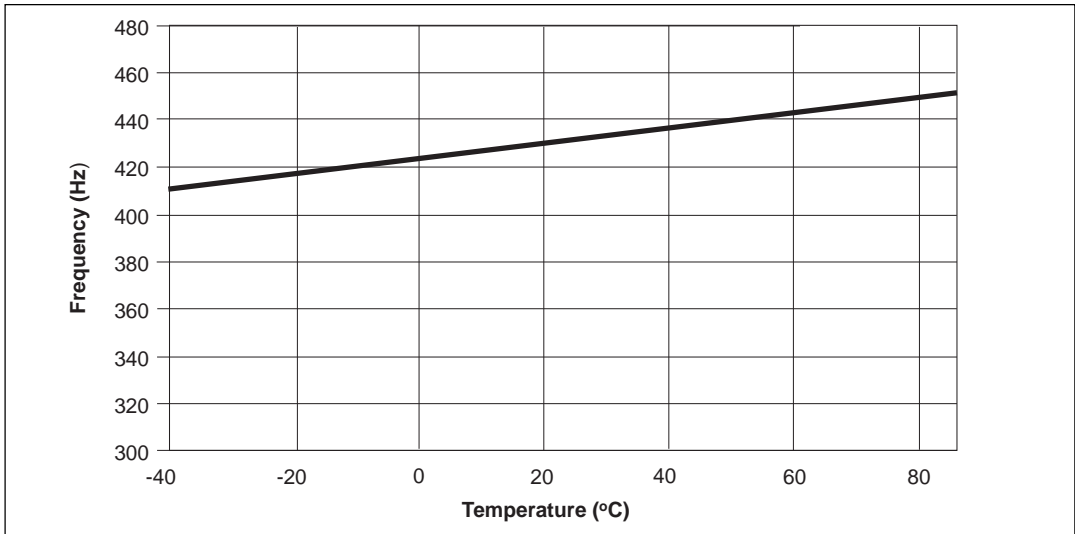

Figure 20. Frequency vs Temperature, $V_{DD} = 5.0V$

The following performance curves are intended to give the designer a relative scale from which to optimize specific applications. Absolute measurements may vary depending upon the brand of components chosen.

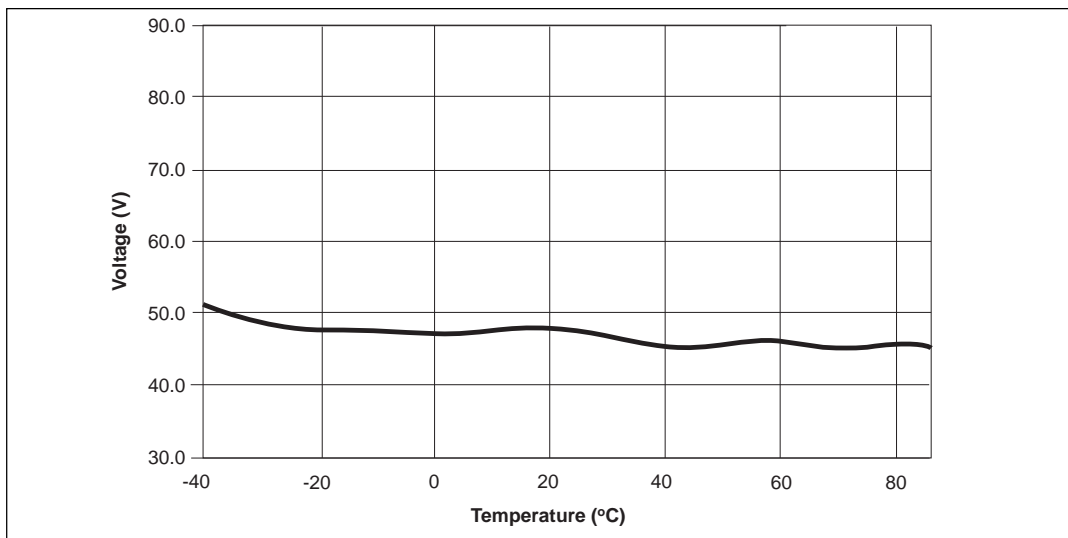

Figure 21. Peak EL Driver Voltage vs Temperature, $V_{DD} = 2.2V$

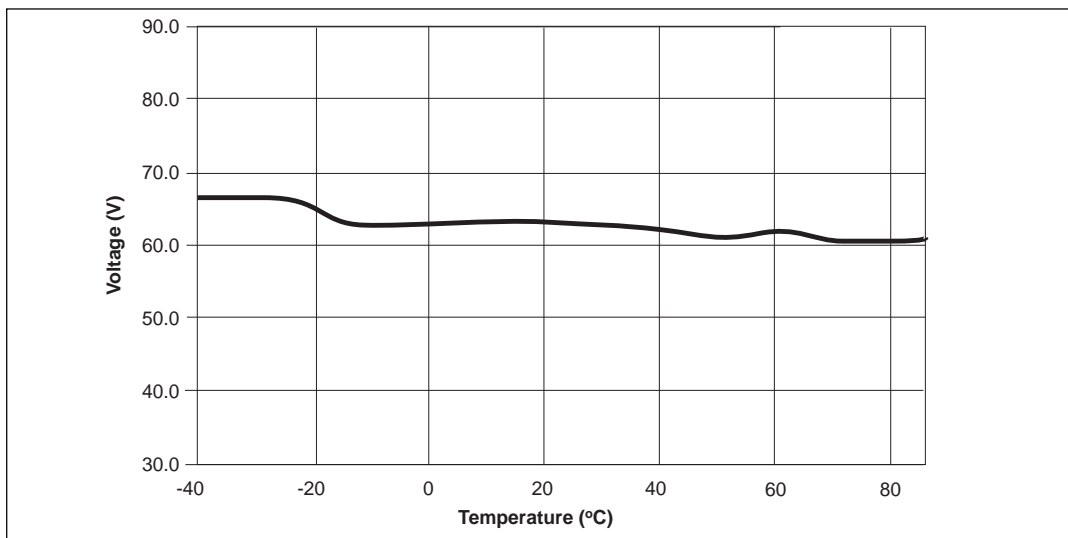

Figure 22. Peak EL Driver Voltage vs Temperature, $V_{DD} = 3.0V$

The following performance curves are intended to give the designer a relative scale from which to optimize specific applications. Absolute measurements may vary depending upon the brand of components chosen.

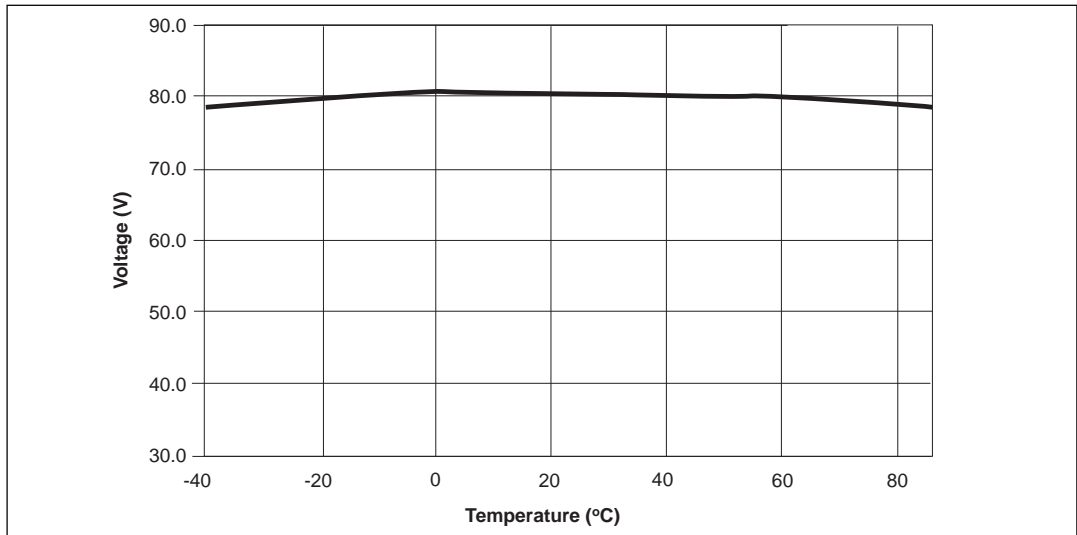

Figure 23. Peak EL Driver Voltage vs Temperature, $V_{DD} = 5.0V$

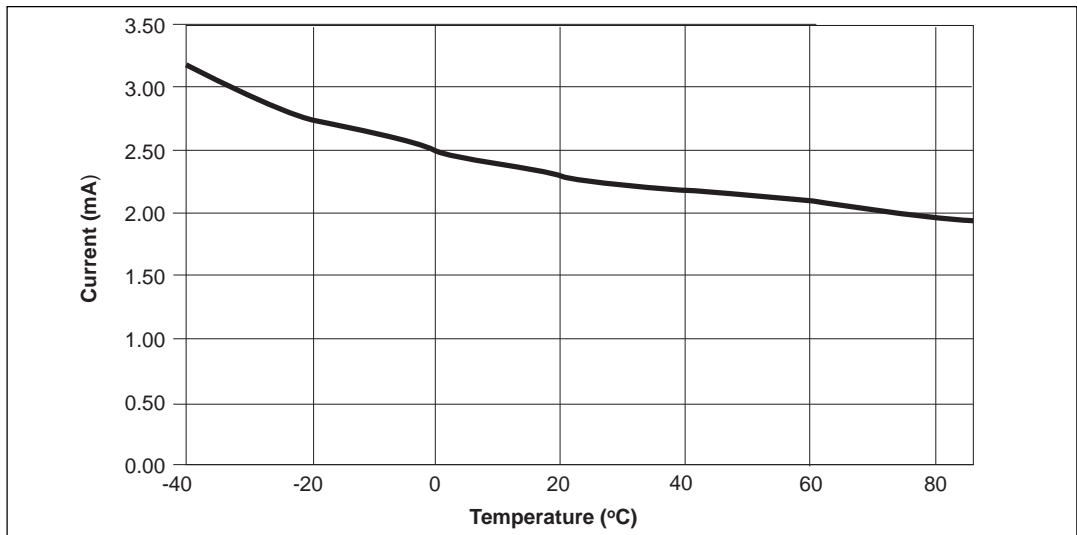

Figure 24. EL Driver Current Draw vs Temperature (not including Coil Current), $V_{DD} = 3.0V$

The following performance curves are intended to give the designer a relative scale from which to optimize specific applications. Absolute measurements may vary depending upon the brand of components chosen.

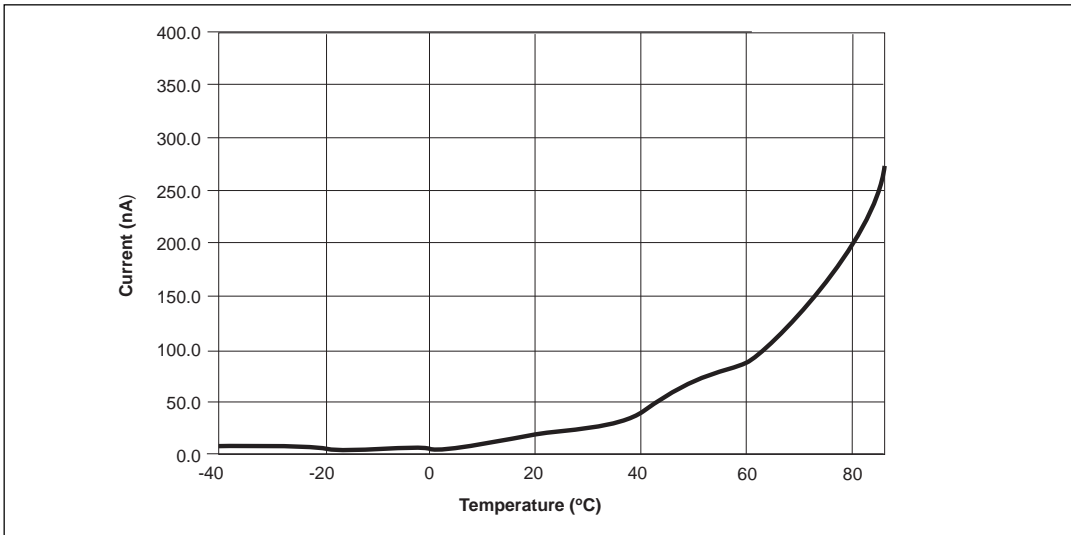
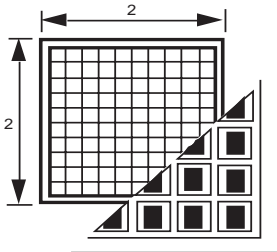
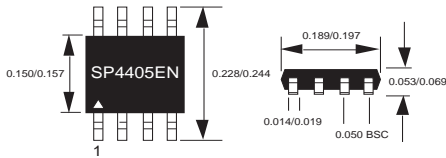

Figure 25. Leakage Current vs Temperature, $V_{DD} = 3.0V$

All package dimensions in inches

8-pin NSOIC



100 die per waffle pack



95 NSOIC devices per tube, no minimum quantity

8-pin μ SOIC

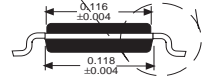
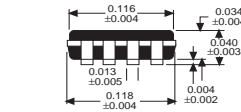
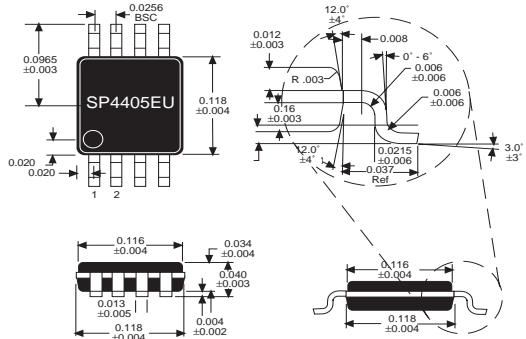

50 μ SOIC devices per tube

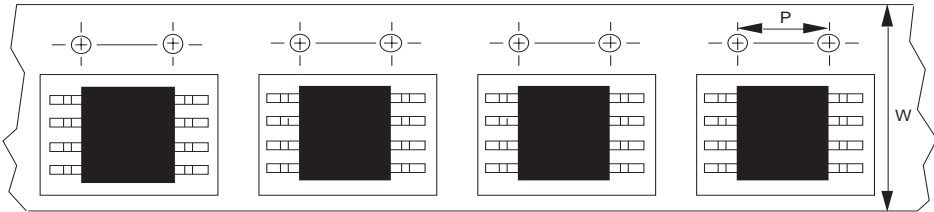

8-pin NSOIC 13" reels: P = 8mm, W = 12mm
8-pin μ SOIC 13" reels: P = 8mm, W = 12mm

Pkg.	min qty per reel	std qty per reel	max qty per reel
EN	500	2500	3000
EU	500	2500	3000

ORDERING INFORMATION

Model	Temperature Range	Package Type
SP4405EN	-40°C to +85°C	8-Pin NSOIC
SP4405EU	-40°C to +85°C	8-Pin μ SOIC
SP4405NEB	N/A	Evaluation Board
SP4405UEB	N/A	Evaluation Board

Please consult the factory for pricing and availability on a Tape-On-Reel option.



SIGNAL PROCESSING EXCELLENCE

Sipex Corporation

Headquarters and Sales Office

22 Linnell Circle
Billerica, MA 01821
TEL: (978) 667-8700
FAX: (978) 670-9001
e-mail: sales@sipex.com

Sales Office

233 South Hillview Drive
Milpitas, CA 95035
TEL: (408) 934-7500
FAX: (408) 935-7600

Sipex Corporation reserves the right to make changes to any products described herein. Sipex does not assume any liability arising out of the application or use of any product or circuit described herein; neither does it convey any license under its patent rights nor the rights of others.