



# AH101

Medium Power, High Linearity Amplifier

## Product Features

- 50-1500 MHz
- +45 dBm Output IP3
- 13 dB Gain
- +27 dBm P1dB
- MTBF >100 Years
- Unconditionally Stable
- Internally Matched
- Single Bias Supply (+7.0 to +9.0 V)



Actual Size

## Product Description

The AH101 is a medium power gain block that offers excellent dynamic range in a low cost surface mount package. The combination of a single supply voltage and an unconditionally stable internally matched device, makes it ideal for both narrow band and broadband applications. Superior thermal design allows the product to achieve +45 dBm OIP3 performance at a mounting temperature of +85°C with an associated MTBF of >100 years<sup>3</sup>.

## Functional Diagram

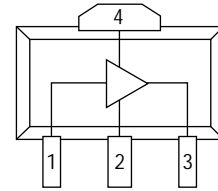

Function	Pin No.
Input	1
Ground	2
Output/Bias	3
Ground	4

## Specifications

Parameter	Units	Min.	Typical	Max.
Frequency Range	MHz		50-1500	
S21 - Gain	dB	12	13.5	
S11 - Input Return Loss	dB		-20	
S22 - Output Return Loss	dB		-13	
Output IP3	dBm	+43	+47	
Output P1dB	dBm		+27	
Noise Figure	dB		5.0	
Operating Current Range	mA	170	200	230
Supply Voltage	V		9.0	

Test conditions unless otherwise noted.

1. T = 25°C, Vdd = 9.0 V, Frequency = 800 MHz, 50 ohm system.

2. OIP3 measured with two tones at an output power of 8 dBm/tone separated by 10 MHz. The suppression on the largest IM3 product is used to calculate the OIP3 using a 2:1 slope rule.

3. MTBF calculated with channel temperature at 155°C.

## Recommended Maximum Ratings

Parameter	Rating
Operating Case Temperature	-40 to +85°C
Storage Temperature	-55 to +125°C
DC Voltage	+11 V
RF Input Power (continuous)	+18 dBm

Operation of this device above any of these parameters may cause permanent damage.

## Typical Parameters

Parameter	Units	Typical	
Frequency	MHz	900	1500
S21	dB	13.5	12
S11	dB	-20	-12
S22	dB	-15	-12
Output IP3	dBm	+47	+46
Output P1dB	dBm	+27.0	+25.0
Noise Figure	dB	3.5	4.0

Typical parameters reflect performance in an application circuit.

## Ordering Information

Part No.	Description
AH101	Medium Power High Linearity Amplifier (Available in tape and reel)
AH101-PCB	Fully Assembled Application Circuit

## Performance Charts (Vd = 9.0 V, Id = 200 mA, T = 25°C)

### Gain vs. Frequency

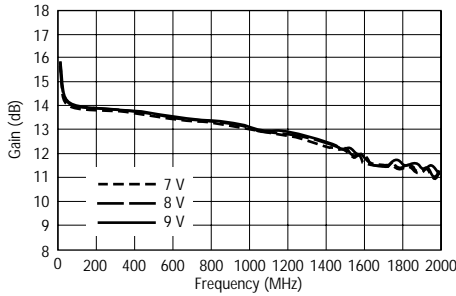

### Return Loss vs. Frequency

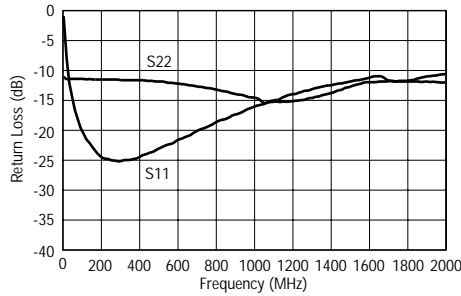

### Noise Figure vs. Frequency

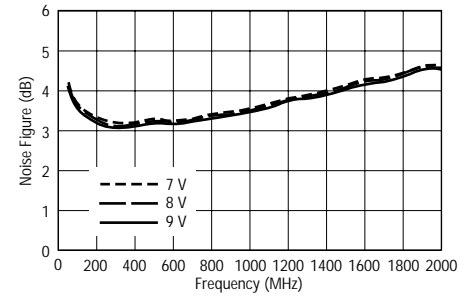

### OIP3 vs. Frequency

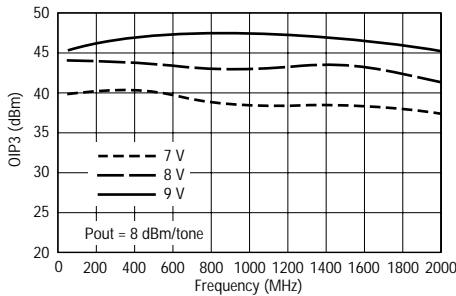

### OIP3 vs. Pout

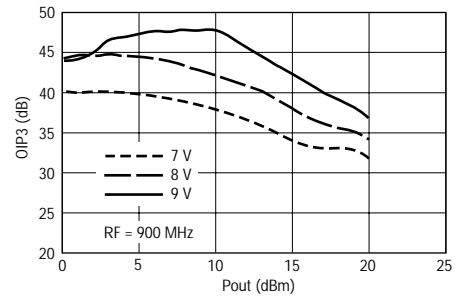

### P1dB vs. Frequency

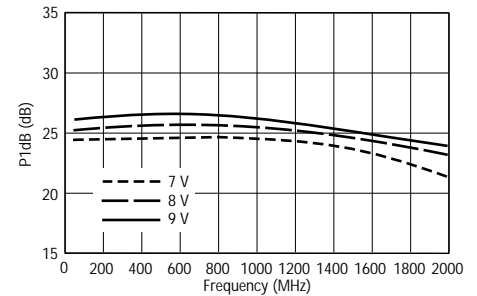

### S21 vs. Frequency over Temperature

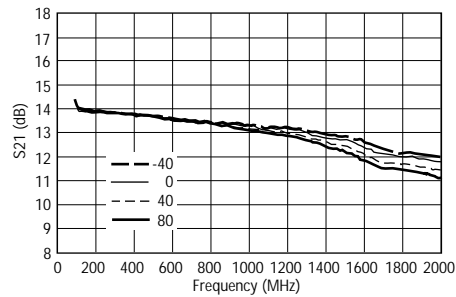

### S11 vs. Frequency over Temperature

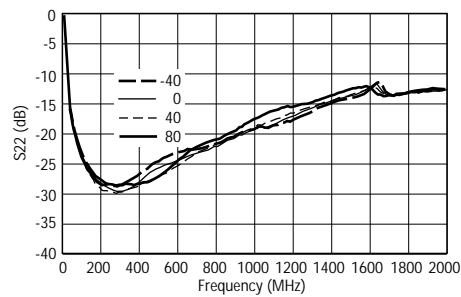

### S22 vs. Frequency over Temperature

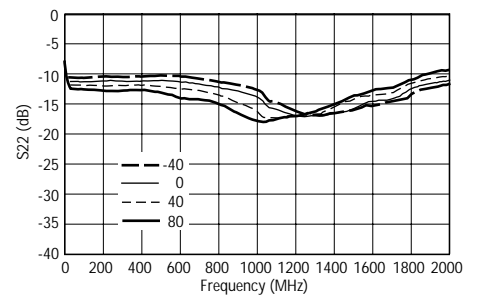

### OIP3 vs. Temperature

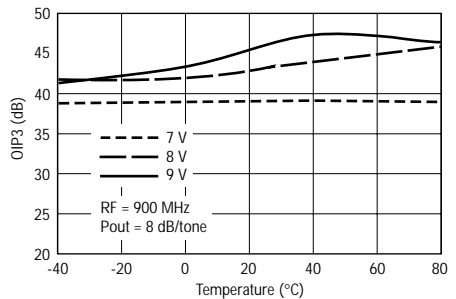

### Gain vs. Pout

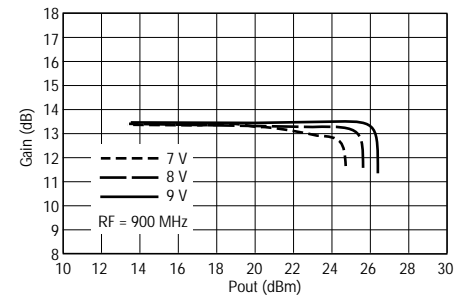

## Application Circuit: 50ohm Evaluation Board

### Typical Performance

Frequency	50 MHz	860 MHz	1500 MHz
Magnitude S21	14.0 dB	13.5 dB	12.0 dB
Magnitude S11	-12.0 dB	-20.0 dB	-12.0 dB
Magnitude S22	-12.0 dB	-15.0 dB	-12.0 dB
OIP3	45.0 dBm	47.0 dBm	46.0 dBm
Noise Figure	4.0 dB	3.5 dB	4.0 dB
Bias	Vd = 9 V, Id = 200 mA		

### Schematic

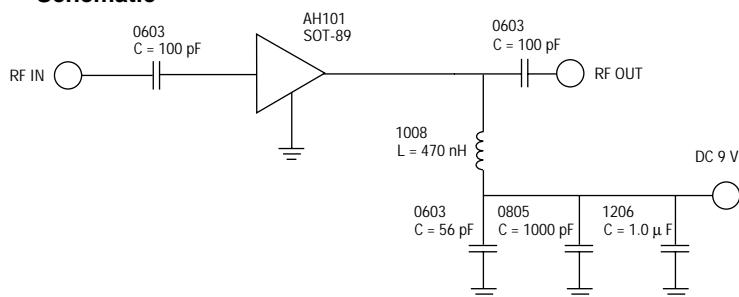

### FR4 Board Layout (T = 14 Mil)

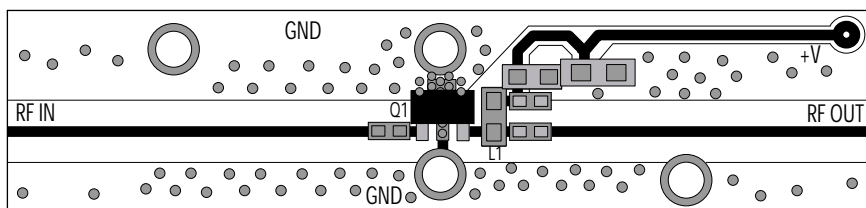

## Thermal Specifications

Parameter	Rating
Operating Case Temperature	-40 to +85°C
Thermal Resistance (Maximum)	25°C/W
Junctions Temperature (Recommended Maximum)	+155°C

#### Notes:

1. Thermal Resistance determined at Maximum Tab Temperature and Maximum Power Dissipation.
2. Recommended Maximum Junction Temperature insures a MTBF of 1 million hours.
3. Refer to WJ Application Note "AH101 Temperature Effects on Reliability" for more information.

### MTBF vs. Temperature

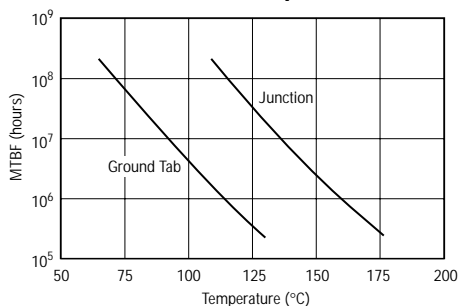

### Outline Drawing

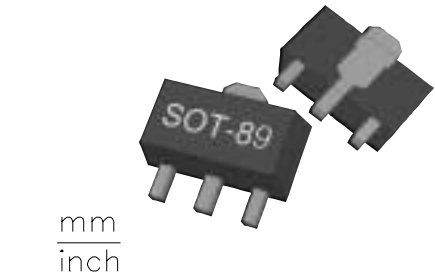
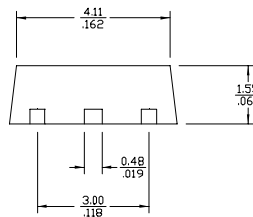
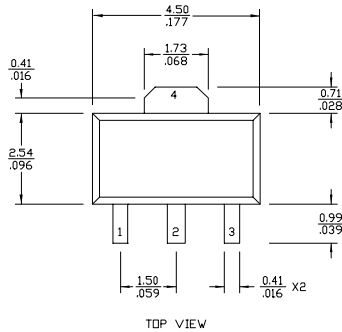

### Land Pattern

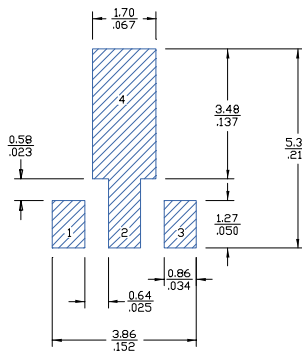

FUNCTION	PIN NO.
INPUT	1
GROUND	2
OUTPUT (BIAS)	3
GROUND	4

- Notes:
1. Ground vias are critical for thermal and RF grounding considerations.
  2. Two 2-56 screws with washers should be used for thermal grounding to the main chassis.
  3. Ground plane on the backside should extend past the holes for the 2-56 screws as a minimum.
  4. No soldermask should be applied to the backside where heat sink area contacts the main chassis.
  5. Holes for the 2-56 screws should be plated through.
  6. Keepout diameter for the 2-56 screw is to allow good thermal contact for the screw and washer.
  7. Trace width depends on PC board.
  8. A minimum of 1 oz. / 1 oz. copper should be used.

### Mounting Configuration

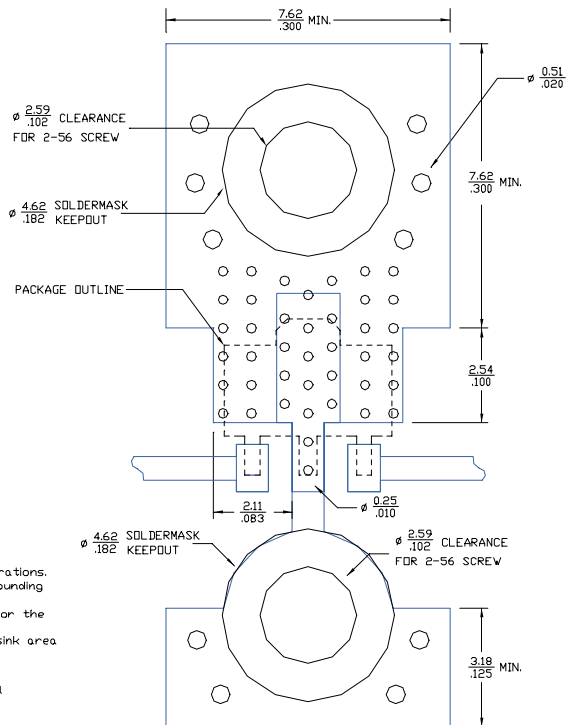

This document contains information on a new product.  
Specifications and information are subject to change without notice.



**Caution!** ESD sensitive device.

## Typical Test Data

S-Parameters (Vds = 9.0 V, Ids = 200 mA, T = 25°C, unmatched device in a 50 ohm system)

Freq (MHz)	S11 (Mag)	S11 (Ang)	S21 (Mag)	S21 (Ang)	S12 (Mag)	S12 (Ang)	S22 (Mag)	S22 (Ang)
0.05	0.0959	-110.85	4.968	171.05	0.103	4.225	0.302	-170.06
0.10	0.0723	-112.91	4.955	170.61	0.102	0.790	0.297	-179.82
0.15	0.0703	-114.59	4.944	169.56	0.102	-1.529	0.298	174.82
0.20	0.0719	-115.94	4.916	168.02	0.103	-4.184	0.303	171.08
0.25	0.0719	-116.09	4.903	166.05	0.101	-5.445	0.260	161.00
0.30	0.0713	-117.70	4.895	163.86	0.101	-7.761	0.264	156.32
0.35	0.0725	-118.68	4.881	161.55	0.102	-8.193	0.268	152.73
0.40	0.0723	-119.46	4.858	159.30	0.103	-9.772	0.271	149.01
0.45	0.0758	-124.56	4.844	157.11	0.102	-11.460	0.273	145.78
0.50	0.0856	-125.91	4.826	154.77	0.099	-12.929	0.274	142.15
0.55	0.0972	-129.25	4.808	152.44	0.100	-14.689	0.275	138.78
0.60	0.1026	-129.83	4.785	150.13	0.102	-15.349	0.278	135.59
0.65	0.1141	-129.99	4.770	147.87	0.100	-15.673	0.279	132.17
0.70	0.1194	-130.49	4.748	145.62	0.100	-17.163	0.282	129.00
0.75	0.1274	-132.04	4.729	143.29	0.097	-19.586	0.282	126.06
0.80	0.1340	-134.79	4.710	141.08	0.097	-20.479	0.281	123.21
0.85	0.1403	-136.04	4.661	138.77	0.098	-20.997	0.280	120.33
0.90	0.1467	-138.98	4.649	136.55	0.094	-23.306	0.278	118.05
0.95	0.1550	-139.78	4.629	134.24	0.097	-23.698	0.277	114.72
1.00	0.1598	-143.31	4.612	132.01	0.095	-25.201	0.276	112.04
1.05	0.1733	-145.77	4.584	129.93	0.093	-26.567	0.271	109.60
1.10	0.1820	-145.80	4.556	127.42	0.093	-26.982	0.266	106.55
1.15	0.1950	-146.37	4.531	125.40	0.092	-29.315	0.262	104.05
1.20	0.2009	-148.27	4.514	123.25	0.093	-29.005	0.258	102.02
1.25	0.1931	-148.96	4.511	120.81	0.093	-31.669	0.239	99.07
1.30	0.2044	-148.12	4.485	118.58	0.091	-32.752	0.228	95.57
1.35	0.2107	-147.11	4.457	116.21	0.091	-33.430	0.219	90.80
1.40	0.2159	-146.41	4.429	113.99	0.089	-33.634	0.209	85.99
1.45	0.2232	-146.08	4.414	111.69	0.089	-36.007	0.198	80.96
1.50	0.2286	-145.80	4.380	109.44	0.090	-37.650	0.188	74.86
1.55	0.2417	-145.81	4.351	107.20	0.087	-37.629	0.179	69.19
1.60	0.2485	-144.28	4.321	104.96	0.086	-40.058	0.173	61.75
1.65	0.2565	-144.16	4.292	102.66	0.084	-39.799	0.165	54.63
1.70	0.2649	-144.02	4.258	100.33	0.083	-42.630	0.158	47.28
1.75	0.2753	-143.58	4.225	98.17	0.082	-43.869	0.154	37.81
1.80	0.2848	-143.91	4.189	95.91	0.082	-44.693	0.152	28.22
1.85	0.2921	-141.92	4.148	93.68	0.079	-45.864	0.154	19.31
1.90	0.2994	-141.30	4.112	91.50	0.080	-47.211	0.156	10.28
1.95	0.3036	-142.04	4.075	89.29	0.075	-48.646	0.162	1.73
2.00	0.3107	-141.08	4.034	87.00	0.076	-48.697	0.170	-6.35

