

BIPOLAR ANALOG INTEGRATED CIRCUIT

μ PC24M00A Series

THREE TERMINAL LOW DROPOUT VOLTAGE REGULATOR

DESCRIPTION

μ PC24M00A Series are low dropout regulators which have 500 mA capable for output current. These ICs are built-in the saturation protection circuit of the output transistor.

FEATURES

- Built-in the saturaiton protection circuit of the output transistor.
- The capability of output current is 500 mA.
- High accuracy of output voltage.
 - $|\Delta V_o| \leq \pm 2\%$ ($T_J = 25\text{ }^\circ\text{C}$)
 - $|\Delta V_o| \leq \pm 3\%$ ($0\text{ }^\circ\text{C} \leq T_J \leq 125\text{ }^\circ\text{C}$)
- Low dropout voltage.
 - $V_{DIF} \leq 1\text{ V}$ ($I_o \leq 500\text{ mA}$, $T_J \leq 125\text{ }^\circ\text{C}$)
- Built-in overcurrent protection circuit, thermal shut-down circuit.
- Built-in Safe Operating Area protection circuit.
- Compatible for μ PC24M00 Series.

CONNECTION DIAGRAM (TOP VIEW)

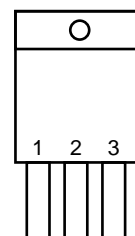

1 : INPUT
2 : GND
3 : OUTPUT

ORDERING INFORMATION

Output Voltage	Type Number	Package
5 V	μ PC24M05AHF	MP-45G (Isolated TO-220)
6 V	μ PC24M06AHF	
7 V	μ PC24M07AHF	
8 V	μ PC24M08AHF	
9 V	μ PC24M09AHF	
10 V	μ PC24M10AHF	
12 V	μ PC24M12AHF	
15 V	μ PC24M15AHF	
18 V	μ PC24M18AHF	

BLOCK DIAGRAM

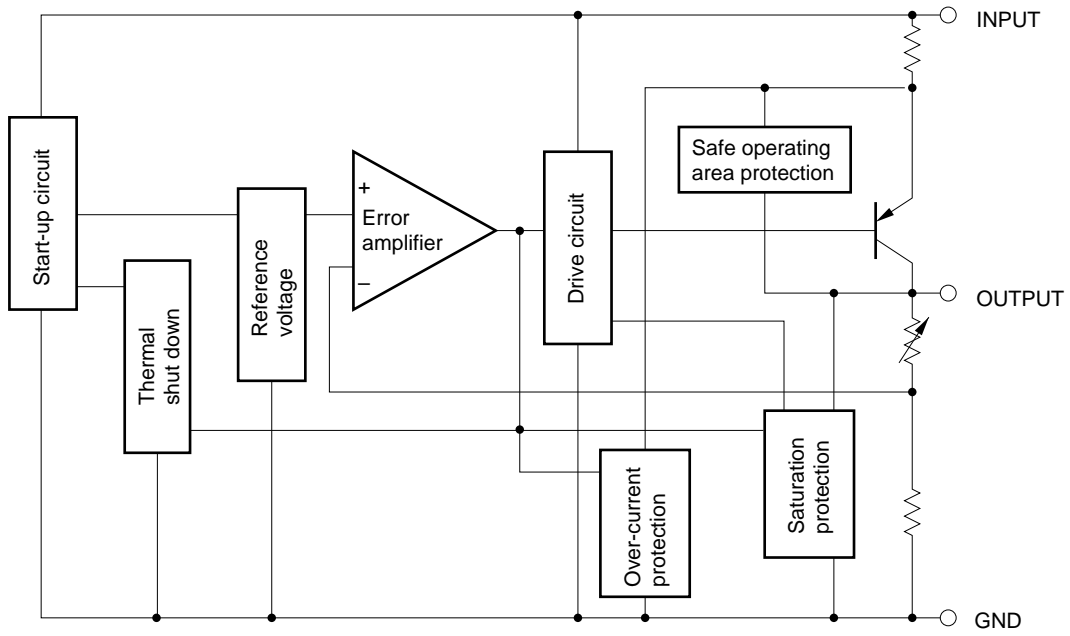

ABSOLUTE MAXIMUM RATINGS (T_A = 25 °C, Unless otherwise specified.)

PARAMETER	SYMBOL	RATING	UNIT
Input Voltage	V _{IN}	36	V
Internal Power Dissipation	P _T	15 Note	W
Operating Ambient Temperature Range	T _A	-20 to +85	°C
Operating Junction Temperature Range	T _J	-20 to +150	°C
Storage Temperature Range	T _{stg}	-55 to +150	°C
Thermal Resistance (Junction to Case)	R _{th(J - C)}	7.0	°C/W
Thermal Resistance (Junction to Ambient)	R _{th(J - A)}	65	°C/W

Note Internally limited.

TYPICAL CONNECTION

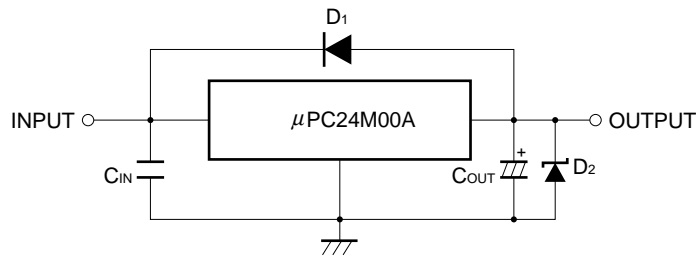

- C_{IN} : 0.1 to 0.47 μF.
- C_{OUT} : More than 47 μF.
- D₁ : Need for V_O > V_{IN}.
- D₂ : Need for V_O < GND.

RECOMMENDED OPERATING CONDITIONS

PARAMETER	SYMBOL	TYPE NUMBER	MIN.	TYP.	MAX.	UNIT
Input Voltage	V _{IN}	μPC24M05AHF	6	9	20	V
		μPC24M06AHF	7	10	21	
		μPC24M07AHF	8	11	22	
		μPC24M08AHF	9	13	23	
		μPC24M09AHF	10	14	24	
		μPC24M10AHF	11	15	25	
		μPC24M12AHF	13	18	27	
		μPC24M15AHF	16	22	27	
μPC24M18AHF	19	25	28			
Output Current	I _o	All	0		500	mA
Operating Ambient Temperature Range	T _A	All	-20		+85	°C
Operating Junction Temperature Range	T _J	All	-20		+125	°C

ELECTRICAL CHARACTERISTICS

μPC24M05A (V_{IN} = 9 V, I_O = 350 mA, T_J = 25 °C, Unless otherwise specified)

PARAMETER	SYMBOL	MIN.	TYP.	MAX.	UNIT	TEST CONDITIONS
Output Voltage	V _O	4.9	5.0	5.1	V	
		4.85		5.15		6 V ≤ V _{IN} ≤ 20 V, 5 mA ≤ I _O ≤ 350 mA, 0 °C ≤ T _J ≤ 125 °C
		4.85		5.15		5 mA ≤ I _O ≤ 500 mA, 0 °C ≤ T _J ≤ 125 °C
Line Regulation	REG _{IN}		5	50	mV	6.5 V ≤ V _{IN} ≤ 20 V
Load Regulation	REG _L		3	25	mV	5 mA ≤ I _O ≤ 500 mA
Quiescent Current	I _{BIAS}		2.3	3.2	mA	I _O = 0
			7	30		I _O = 500 mA
Start-up Current	I _{BIAS(S)}			15	mA	V _{IN} = 4.5 V, I _O = 0 mA
				45		V _{IN} = 4.5 V, I _O = 500 mA
Quiescent Current Change	ΔI _{BIAS}			10	mA	6.5 V ≤ V _{IN} ≤ 20 V, I _O = 500 mA
Output Noise Voltage	V _n		90		μV _{rms}	10 Hz ≤ f ≤ 100 kHz
Ripple Rejection	R·R	55	60		dB	f = 120 Hz, 6.5 V ≤ V _{IN} ≤ 16.5 V
Dropout Voltage	V _{DIF}		0.5	1.0	V	I _O = 500 mA, 0 °C ≤ T _J ≤ 125 °C
Short Circuit Current	I _{Oshort}		0.6		A	V _{IN} = 20 V
Peak Output Current	I _{Opeak}	0.75	1.0	1.63	A	V _{IN} = 9 V
Temperature Coefficient of Output Voltage	ΔV _O /ΔT		0.2		mV/°C	I _O = 5 mA, 0 °C ≤ T _J ≤ 125 °C

μPC24M06A (V_{IN} = 10 V, I_O = 350 mA, T_J = 25 °C, Unless otherwise specified)

PARAMETER	SYMBOL	MIN.	TYP.	MAX.	UNIT	TEST CONDITIONS
Output Voltage	V _O	5.88	6.0	6.12	V	
		5.82		6.18		7 V ≤ V _{IN} ≤ 21 V, 5 mA ≤ I _O ≤ 350 mA, 0 °C ≤ T _J ≤ 125 °C
		5.82		6.18		5 mA ≤ I _O ≤ 500 mA, 0 °C ≤ T _J ≤ 125 °C
Line Regulation	REG _{IN}		6	60	mV	7.5 V ≤ V _{IN} ≤ 21 V
Load Regulation	REG _L		4	30	mV	5 mA ≤ I _O ≤ 500 mA
Quiescent Current	I _{BIAS}		2.3	3.2	mA	I _O = 0
			7	30		I _O = 500 mA
Start-up Current	I _{BIAS(S)}			15	mA	V _{IN} = 5.5 V, I _O = 0 mA
				45		V _{IN} = 5.5 V, I _O = 500 mA
Quiescent Current Change	ΔI _{BIAS}			10	mA	7.5 V ≤ V _{IN} ≤ 21 V, I _O = 500 mA
Output Noise Voltage	V _n		110		μV _{rms}	10 Hz ≤ f ≤ 100 kHz
Ripple Rejection	R·R	53	58		dB	f = 120 Hz, 7.5 V ≤ V _{IN} ≤ 17.5 V
Dropout Voltage	V _{DIF}		0.5	1.0	V	I _O = 500 mA, 0 °C ≤ T _J ≤ 125 °C
Short Circuit Current	I _{Oshort}		0.6		A	V _{IN} = 21 V
Peak Output Current	I _{Opeak}	0.75	1.0	1.63	A	V _{IN} = 10 V
Temperature Coefficient of Output Voltage	ΔV _O /ΔT		-0.4		mV/°C	I _O = 5 mA, 0 °C ≤ T _J ≤ 125 °C

μPC24M07A (V_{IN} = 11 V, I_o = 350 mA, T_J = 25 °C, Unless otherwise specified)

PARAMETER	SYMBOL	MIN.	TYP.	MAX.	UNIT	TEST CONDITIONS
Output Voltage	V _O	6.86	7.0	7.14	V	
		6.79		7.21		8 V ≤ V _{IN} ≤ 22 V, 5 mA ≤ I _o ≤ 350 mA, 0 °C ≤ T _J ≤ 125 °C
		6.79		7.21		5 mA ≤ I _o ≤ 500 mA, 0 °C ≤ T _J ≤ 125 °C
Line Regulation	REG _{IN}		7	70	mV	8.5 V ≤ V _{IN} ≤ 22 V
Load Regulation	REG _L		4	35	mV	5 mA ≤ I _o ≤ 500 mA
Quiescent Current	I _{BIAS}		2.3	3.2	mA	I _o = 0
			7	30		I _o = 500 mA
Start-up Current	I _{BIAS(S)}			15	mA	V _{IN} = 6.5 V, I _o = 0 mA
				45		V _{IN} = 6.5 V, I _o = 500 mA
Quiescent Current Change	ΔI _{BIAS}			10	mA	8.5 V ≤ V _{IN} ≤ 22 V, I _o = 500 mA
Output Noise Voltage	V _n		130		μV _{rms}	10 Hz ≤ f ≤ 100 kHz
Ripple Rejection	R·R	52	57		dB	f = 120 Hz, 8.5 V ≤ V _{IN} ≤ 18.5 V
Dropout Voltage	V _{DIF}		0.5	1.0	V	I _o = 500 mA, 0 °C ≤ T _J ≤ 125 °C
Short Circuit Current	I _{short}		0.6		A	V _{IN} = 22 V
Peak Output Current	I _{peak}	0.75	1.0	1.63	A	V _{IN} = 11 V
Temperature Coefficient of Output Voltage	ΔV _O /ΔT		0.4		mV/°C	I _o = 5 mA, 0 °C ≤ T _J ≤ 125 °C

μPC24M08A (V_{IN} = 13 V, I_o = 350 mA, T_J = 25 °C, Unless otherwise specified)

PARAMETER	SYMBOL	MIN.	TYP.	MAX.	UNIT	TEST CONDITIONS
Output Voltage	V _O	7.85	8.0	8.15	V	
		7.75		8.25		9 V ≤ V _{IN} ≤ 23 V, 5 mA ≤ I _o ≤ 350 mA, 0 °C ≤ T _J ≤ 125 °C
		7.75		8.25		5 mA ≤ I _o ≤ 500 mA, 0 °C ≤ T _J ≤ 125 °C
Line Regulation	REG _{IN}		8	80	mV	9.5 V ≤ V _{IN} ≤ 23 V
Load Regulation	REG _L		5	40	mV	5 mA ≤ I _o ≤ 500 mA
Quiescent Current	I _{BIAS}		2.3	3.2	mA	I _o = 0
			7	30		I _o = 500 mA
Start-up Current	I _{BIAS(S)}			15	mA	V _{IN} = 7.5 V, I _o = 0 mA
				45		V _{IN} = 7.5 V, I _o = 500 mA
Quiescent Current Change	ΔI _{BIAS}			10	mA	9.5 V ≤ V _{IN} ≤ 23 V, I _o = 500 mA
Output Noise Voltage	V _n		150		μV _{rms}	10 Hz ≤ f ≤ 100 kHz
Ripple Rejection	R·R	51	56		dB	f = 120 Hz, 9.5 V ≤ V _{IN} ≤ 19.5 V
Dropout Voltage	V _{DIF}		0.5	1.0	V	I _o = 500 mA, 0 °C ≤ T _J ≤ 125 °C
Short Circuit Current	I _{short}		0.5		A	V _{IN} = 23 V
Peak Output Current	I _{peak}	0.74	1.0	1.62	A	V _{IN} = 13 V
Temperature Coefficient of Output Voltage	ΔV _O /ΔT		0.8		mV/°C	I _o = 5 mA, 0 °C ≤ T _J ≤ 125 °C

μPC24M09A ($V_{IN} = 14\text{ V}$, $I_o = 350\text{ mA}$, $T_J = 25\text{ °C}$, Unless otherwise specified)

PARAMETER	SYMBOL	MIN.	TYP.	MAX.	UNIT	TEST CONDITIONS
Output Voltage	V_o	8.82	9.0	9.18	V	
		8.73		9.27		$10\text{ V} \leq V_{IN} \leq 24\text{ V}$, $5\text{ mA} \leq I_o \leq 350\text{ mA}$, $0\text{ °C} \leq T_J \leq 125\text{ °C}$
		8.73		9.27		$5\text{ mA} \leq I_o \leq 500\text{ mA}$, $0\text{ °C} \leq T_J \leq 125\text{ °C}$
Line Regulation	REG_{IN}		9	90	mV	$10.5\text{ V} \leq V_{IN} \leq 24\text{ V}$
Load Regulation	REG_L		5	45	mV	$5\text{ mA} \leq I_o \leq 500\text{ mA}$
Quiescent Current	I_{BIAS}		2.4	3.2	mA	$I_o = 0$
			7	30		$I_o = 500\text{ mA}$
Start-up Current	$I_{BIAS(S)}$			15	mA	$V_{IN} = 8.5\text{ V}$, $I_o = 0\text{ mA}$
				45		$V_{IN} = 8.5\text{ V}$, $I_o = 500\text{ mA}$
Quiescent Current Change	ΔI_{BIAS}			10	mA	$10.5\text{ V} \leq V_{IN} \leq 24\text{ V}$, $I_o = 500\text{ mA}$
Output Noise Voltage	V_n		170		μV_{rms}	$10\text{ Hz} \leq f \leq 100\text{ kHz}$
Ripple Rejection	R·R	50	55		dB	$f = 120\text{ Hz}$, $10.5\text{ V} \leq V_{IN} \leq 20.5\text{ V}$
Dropout Voltage	V_{DIF}		0.5	1.0	V	$I_o = 500\text{ mA}$, $0\text{ °C} \leq T_J \leq 125\text{ °C}$
Short Circuit Current	I_{Oshort}		0.5		A	$V_{IN} = 24\text{ V}$
Peak Output Current	I_{Opeak}	0.74	1.0	1.62	A	$V_{IN} = 14\text{ V}$
Temperature Coefficient of Output Voltage	$\Delta V_o/\Delta T$		1.0		$mV/°C$	$I_o = 5\text{ mA}$, $0\text{ °C} \leq T_J \leq 125\text{ °C}$

μPC24M10A ($V_{IN} = 15\text{ V}$, $I_o = 350\text{ mA}$, $T_J = 25\text{ °C}$, Unless otherwise specified)

PARAMETER	SYMBOL	MIN.	TYP.	MAX.	UNIT	TEST CONDITIONS
Output Voltage	V_o	9.8	10	10.2	V	
		9.7		10.3		$11\text{ V} \leq V_{IN} \leq 25\text{ V}$, $5\text{ mA} \leq I_o \leq 350\text{ mA}$, $0\text{ °C} \leq T_J \leq 125\text{ °C}$
		9.7		10.3		$5\text{ mA} \leq I_o \leq 500\text{ mA}$, $0\text{ °C} \leq T_J \leq 125\text{ °C}$
Line Regulation	REG_{IN}		10	100	mV	$11.5\text{ V} \leq V_{IN} \leq 25\text{ V}$
Load Regulation	REG_L		6	50	mV	$5\text{ mA} \leq I_o \leq 500\text{ mA}$
Quiescent Current	I_{BIAS}		2.4	3.2	mA	$I_o = 0$
			7	30		$I_o = 500\text{ mA}$
Start-up Current	$I_{BIAS(S)}$			15	mA	$V_{IN} = 9.5\text{ V}$, $I_o = 0\text{ mA}$
				45		$V_{IN} = 9.5\text{ V}$, $I_o = 500\text{ mA}$
Quiescent Current Change	ΔI_{BIAS}			10	mA	$11.5\text{ V} \leq V_{IN} \leq 25\text{ V}$, $I_o = 500\text{ mA}$
Output Noise Voltage	V_n		190		μV_{rms}	$10\text{ Hz} \leq f \leq 100\text{ kHz}$
Ripple Rejection	R·R	49	54		dB	$f = 120\text{ Hz}$, $11.5\text{ V} \leq V_{IN} \leq 21.5\text{ V}$
Dropout Voltage	V_{DIF}		0.5	1.0	V	$I_o = 500\text{ mA}$, $0\text{ °C} \leq T_J \leq 125\text{ °C}$
Short Circuit Current	I_{Oshort}		0.4		A	$V_{IN} = 25\text{ V}$
Peak Output Current	I_{Opeak}	0.74	1.0	1.62	A	$V_{IN} = 15\text{ V}$
Temperature Coefficient of Output Voltage	$\Delta V_o/\Delta T$		1.6		$mV/°C$	$I_o = 5\text{ mA}$, $0\text{ °C} \leq T_J \leq 125\text{ °C}$

μ PC24M12A ($V_{IN} = 18\text{ V}$, $I_o = 350\text{ mA}$, $T_J = 25\text{ }^\circ\text{C}$, Unless otherwise specified)

PARAMETER	SYMBOL	MIN.	TYP.	MAX.	UNIT	TEST CONDITIONS
Output Voltage	V_o	11.75	12	12.25	V	
		11.65		12.35		$13\text{ V} \leq V_{IN} \leq 27\text{ V}$, $5\text{ mA} \leq I_o \leq 350\text{ mA}$, $0\text{ }^\circ\text{C} \leq T_J \leq 125\text{ }^\circ\text{C}$
		11.65		12.35		$5\text{ mA} \leq I_o \leq 500\text{ mA}$, $0\text{ }^\circ\text{C} \leq T_J \leq 125\text{ }^\circ\text{C}$
Line Regulation	REG_{IN}		12	120	mV	$14\text{ V} \leq V_{IN} \leq 27\text{ V}$
Load Regulation	REG_L		7	60	mV	$5\text{ mA} \leq I_o \leq 500\text{ mA}$
Quiescent Current	I_{BIAS}		2.4	3.2	mA	$I_o = 0$
			8	30		$I_o = 500\text{ mA}$
Start-up Current	$I_{BIAS(S)}$			15	mA	$V_{IN} = 11.5\text{ V}$, $I_o = 0\text{ mA}$
				45		$V_{IN} = 11.5\text{ V}$, $I_o = 500\text{ mA}$
Quiescent Current Change	ΔI_{BIAS}			10	mA	$14\text{ V} \leq V_{IN} \leq 27\text{ V}$, $I_o = 500\text{ mA}$
Output Noise Voltage	V_n		230		μV_{rms}	$10\text{ Hz} \leq f \leq 100\text{ kHz}$
Ripple Rejection	R·R	47	52		dB	$f = 120\text{ Hz}$, $14\text{ V} \leq V_{IN} \leq 24\text{ V}$
Dropout Voltage	V_{DIF}		0.5	1.0	V	$I_o = 500\text{ mA}$, $0\text{ }^\circ\text{C} \leq T_J \leq 125\text{ }^\circ\text{C}$
Short Circuit Current	I_{short}		0.4		A	$V_{IN} = 27\text{ V}$
Peak Output Current	I_{peak}	0.73	1.0	1.61	A	$V_{IN} = 18\text{ V}$
Temperature Coefficient of Output Voltage	$\Delta V_o/\Delta T$		0.7		$\text{mV}/^\circ\text{C}$	$I_o = 5\text{ mA}$, $0\text{ }^\circ\text{C} \leq T_J \leq 125\text{ }^\circ\text{C}$

μ PC24M15A ($V_{IN} = 22\text{ V}$, $I_o = 350\text{ mA}$, $T_J = 25\text{ }^\circ\text{C}$, Unless otherwise specified)

PARAMETER	SYMBOL	MIN.	TYP.	MAX.	UNIT	TEST CONDITIONS
Output Voltage	V_o	14.7	15	15.3	V	
		14.55		15.45		$16\text{ V} \leq V_{IN} \leq 27\text{ V}$, $5\text{ mA} \leq I_o \leq 350\text{ mA}$, $0\text{ }^\circ\text{C} \leq T_J \leq 125\text{ }^\circ\text{C}$
		14.55		15.45		$5\text{ mA} \leq I_o \leq 500\text{ mA}$, $0\text{ }^\circ\text{C} \leq T_J \leq 125\text{ }^\circ\text{C}$
Line Regulation	REG_{IN}		15	150	mV	$17\text{ V} \leq V_{IN} \leq 27\text{ V}$
Load Regulation	REG_L		9	75	mV	$5\text{ mA} \leq I_o \leq 500\text{ mA}$
Quiescent Current	I_{BIAS}		2.5	3.2	mA	$I_o = 0$
			8	30		$I_o = 500\text{ mA}$
Start-up Current	$I_{BIAS(S)}$			15	mA	$V_{IN} = 14.5\text{ V}$, $I_o = 0\text{ mA}$
				45		$V_{IN} = 14.5\text{ V}$, $I_o = 500\text{ mA}$
Quiescent Current Change	ΔI_{BIAS}			10	mA	$17\text{ V} \leq V_{IN} \leq 27\text{ V}$, $I_o = 500\text{ mA}$
Output Noise Voltage	V_n		290		μV_{rms}	$10\text{ Hz} \leq f \leq 100\text{ kHz}$
Ripple Rejection	R·R	46	51		dB	$f = 120\text{ Hz}$, $17\text{ V} \leq V_{IN} \leq 27\text{ V}$
Dropout Voltage	V_{DIF}		0.5	1.0	V	$I_o = 500\text{ mA}$, $0\text{ }^\circ\text{C} \leq T_J \leq 125\text{ }^\circ\text{C}$
Short Circuit Current	I_{short}		0.4		A	$V_{IN} = 27\text{ V}$
Peak Output Current	I_{peak}	0.72	1.0	1.6	A	$V_{IN} = 22\text{ V}$
Temperature Coefficient of Output Voltage	$\Delta V_o/\Delta T$		1.6		$\text{mV}/^\circ\text{C}$	$I_o = 5\text{ mA}$, $0\text{ }^\circ\text{C} \leq T_J \leq 125\text{ }^\circ\text{C}$

μPC24M18A ($V_{IN} = 25\text{ V}$, $I_o = 350\text{ mA}$, $T_J = 25\text{ °C}$, Unless otherwise specified)

PARAMETER	SYMBOL	MIN.	TYP.	MAX.	UNIT	TEST CONDITIONS
Output Voltage	V_o	17.64	18	18.36	V	
		17.46		18.54		$19\text{ V} \leq V_{IN} \leq 28\text{ V}$, $5\text{ mA} \leq I_o \leq 350\text{ mA}$, $0\text{ °C} \leq T_J \leq 125\text{ °C}$
		17.46		18.54		$5\text{ mA} \leq I_o \leq 500\text{ mA}$, $0\text{ °C} \leq T_J \leq 125\text{ °C}$
Line Regulation	REG_{IN}		18	180	mV	$20\text{ V} \leq V_{IN} \leq 28\text{ V}$
Load Regulation	REG_L		11	90	mV	$5\text{ mA} \leq I_o \leq 500\text{ mA}$
Quiescent Current	I_{BIAS}		2.5	3.2	mA	$I_o = 0$
			8	30		$I_o = 500\text{ mA}$
Start-up Current	$I_{BIAS(S)}$			15	mA	$V_{IN} = 17.5\text{ V}$, $I_o = 0\text{ mA}$
				45		$V_{IN} = 17.5\text{ V}$, $I_o = 500\text{ mA}$
Quiescent Current Change	ΔI_{BIAS}			10	mA	$20\text{ V} \leq V_{IN} \leq 28\text{ V}$, $I_o = 500\text{ mA}$
Output Noise Voltage	V_n		350		μV_{rms}	$10\text{ Hz} \leq f \leq 100\text{ kHz}$
Ripple Rejection	R·R	44	49		dB	$f = 120\text{ Hz}$, $20\text{ V} \leq V_{IN} \leq 28\text{ V}$
Dropout Voltage	V_{DIF}		0.5	1.0	V	$I_o = 500\text{ mA}$, $0\text{ °C} \leq T_J \leq 125\text{ °C}$
Short Circuit Current	I_{Oshort}		0.4		A	$V_{IN} = 28\text{ V}$
Peak Output Current	I_{Opeak}	0.72	1.0	1.6	A	$V_{IN} = 25\text{ V}$
Temperature Coefficient of Output Voltage	$\Delta V_o/\Delta T$		2.2		mV/°C	$I_o = 5\text{ mA}$, $0\text{ °C} \leq T_J \leq 125\text{ °C}$

TYPICAL CHARACTERISTICS

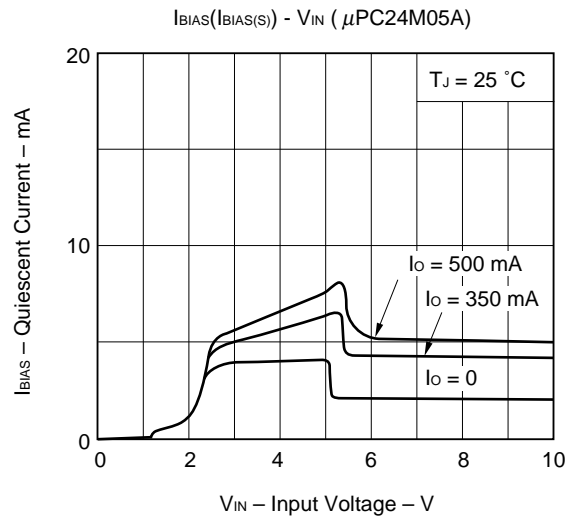
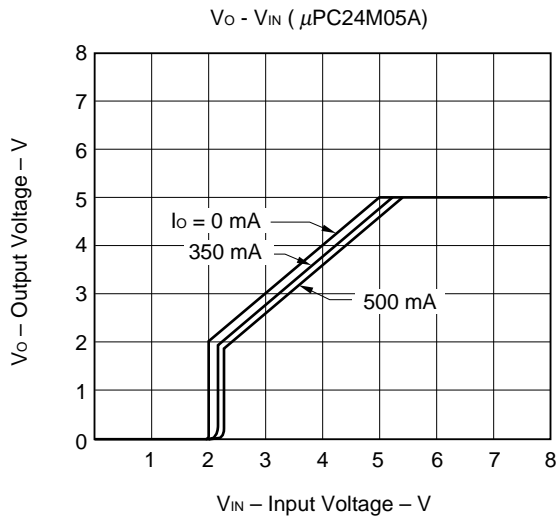
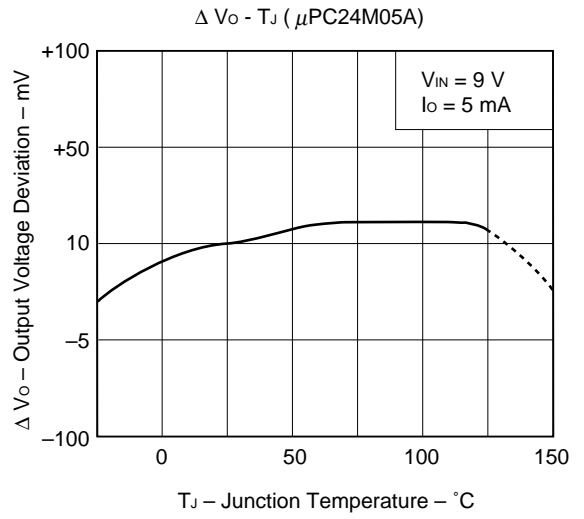
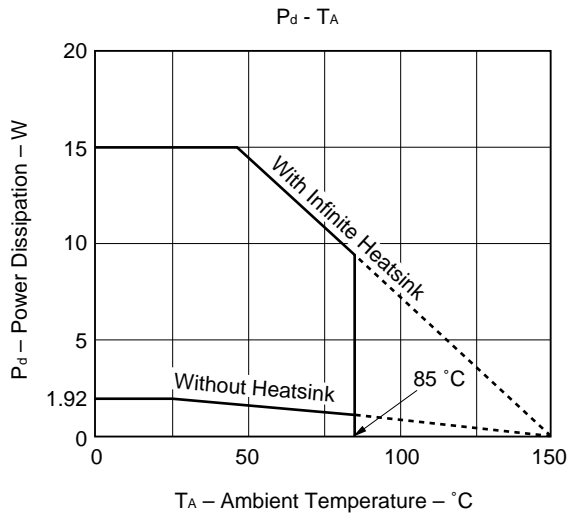

TYPICAL CHARACTERISTICS

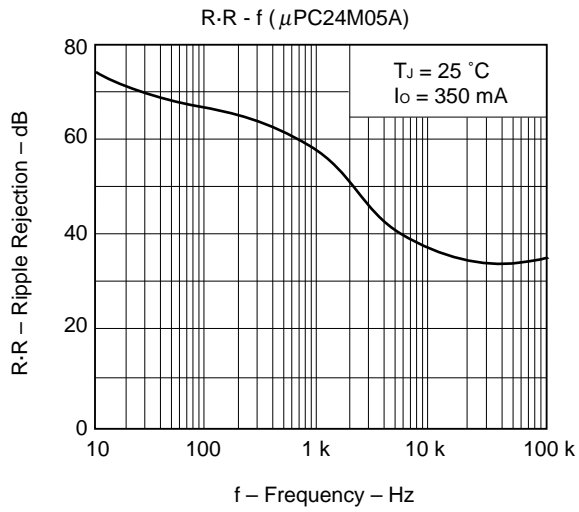
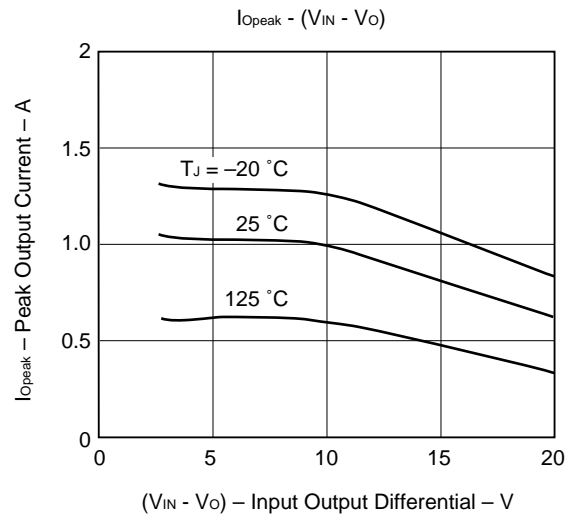
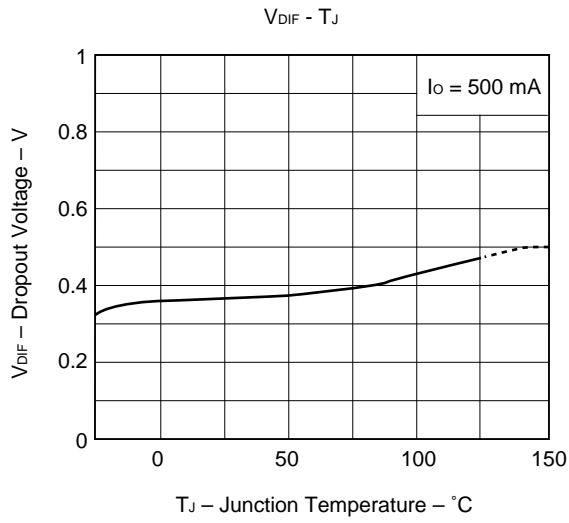

PACKAGE DIMENSIONS (Unit: mm)

μPC24M00AHF Series

3PIN PLASTIC SIP (MP-45G)

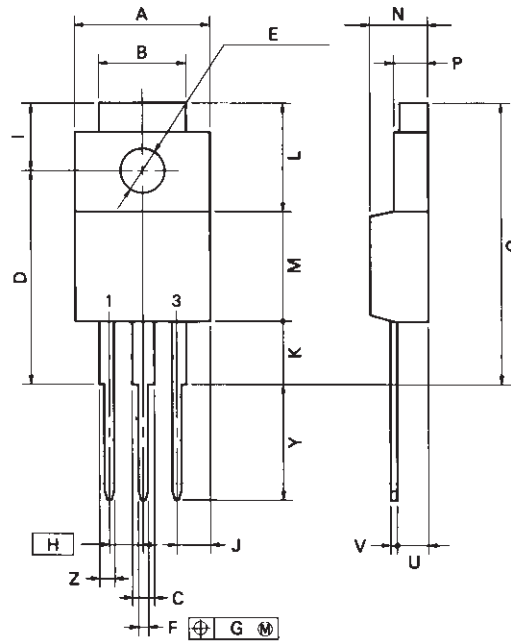

P3HF-254B-1

NOTE

Each lead centerline is located within 0.25 mm (0.01 inch) of its true position (T.P.) at maximum material condition.

ITEM	MILLIMETERS	INCHES
A	10.4 MAX.	0.410 MAX.
B	7.0	0.276
C	1.2 MIN.	0.047 MIN.
D	17.0 ^{±0.3}	0.669 ^{+0.013} _{-0.012}
E	φ3.3 ^{±0.2}	φ0.130 ^{+0.008}
F	0.75 ^{±0.10}	0.030 ^{+0.004} _{-0.006}
G	0.25	0.010
H	2.54 (T.P.)	0.100 (T.P.)
I	5.0 ^{±0.3}	0.197 ^{±0.012}
J	2.66 MAX.	0.105 MAX.
K	4.8 MIN.	0.188 MIN.
L	8.5	0.335
M	8.5	0.335
N	4.5 ^{±0.2}	0.177 ^{±0.008}
P	2.8 ^{±0.2}	0.110 ^{+0.003} _{-0.006}
Q	22.4 MAX.	0.882 MAX.
U	2.4 ^{±0.5}	0.094 ^{+0.021} _{-0.020}
V	0.65 ^{±0.10}	0.026 ^{+0.004} _{-0.006}
Y	8.9 ^{±0.7}	0.350 ^{±0.028}
Z	1.0 MIN.	0.039 MIN.

RECOMMENDED SOLDERING CONDITIONS

The following conditions (see table below) must be met when soldering this product.

Please consult with our sales offices in case other soldering process is used, or in case soldering is done under different conditions.

TYPES OF THROUGH HOLE MOUNT DEVICE

μPC24M00AHF Series

Soldering Process	Soldering Conditions	Symbol
Wave soldering	Solder temperature: 260 °C or below. Flow Time: 10 seconds or below.	

REFERENCE

Document Name	Document No.
NEC semiconductor device reliability/quality control system	IEI-1212
Quality grade on NEC semiconductor devices	IEI-1209
Semiconductor device mounting technology manual	IEI-1207
Semiconductor device package manual	IEI-1213
Guide to quality assurance for semiconductor devices	MEI-1202
Semiconductor selection guide	MF-1134

[MEMO]

No part of this document may be copied or reproduced in any form or by any means without the prior written consent of NEC Corporation. NEC Corporation assumes no responsibility for any errors which may appear in this document.

NEC Corporation does not assume any liability for infringement of patents, copyrights or other intellectual property rights of third parties by or arising from use of a device described herein or any other liability arising from use of such device. No license, either express, implied or otherwise, is granted under any patents, copyrights or other intellectual property rights of NEC Corporation or others.

While NEC Corporation has been making continuous effort to enhance the reliability of its semiconductor devices, the possibility of defects cannot be eliminated entirely. To minimize risks of damage or injury to persons or property arising from a defect in an NEC semiconductor device, customer must incorporate sufficient safety measures in its design, such as redundancy, fire-containment, and anti-failure features.

NEC devices are classified into the following three quality grades:

“Standard”, “Special”, and “Specific”. The Specific quality grade applies only to devices developed based on a customer designated “quality assurance program” for a specific application. The recommended applications of a device depend on its quality grade, as indicated below. Customers must check the quality grade of each device before using it in a particular application.

Standard: Computers, office equipment, communications equipment, test and measurement equipment, audio and visual equipment, home electronic appliances, machine tools, personal electronic equipment and industrial robots

Special: Transportation equipment (automobiles, trains, ships, etc.), traffic control systems, anti-disaster systems, anti-crime systems, safety equipment and medical equipment (not specifically designed for life support)

Specific: Aircrafts, aerospace equipment, submersible repeaters, nuclear reactor control systems, life support systems or medical equipment for life support, etc.

The quality grade of NEC devices in “Standard” unless otherwise specified in NEC's Data Sheets or Data Books. If customers intend to use NEC devices for applications other than those specified for Standard quality grade, they should contact NEC Sales Representative in advance.

Anti-radioactive design is not implemented in this product.