



STPS1545D/F/FP/R/G

POWER SCHOTTKY RECTIFIER

MAIN PRODUCT CHARACTERISTICS

I_{F(AV)}	15 A
V_{RRM}	45 V
T_{j (max)}	175 °C
V_{F (max)}	0.57 V

FEATURES AND BENEFITS

- VERY SMALL CONDUCTION LOSSES
- NEGLIGIBLE SWITCHING LOSSES
- EXTREMELY FAST SWITCHING
- INSULATED PACKAGE: ISOWATT220AC, TO-220FPAC
Insulating voltage = 2000V DC
Capacitance = 12pF
- AVALANCHE CAPABILITY SPECIFIED

DESCRIPTION

Single chip Schottky rectifier suited for Switch Mode Power Supply and high frequency DC to DC converters.

Packaged in TO-220AC, ISOWATT220AC, TO-220FPAC, I²PAK or D²PAK, this device is intended for use in low voltage, high frequency inverters, free wheeling and polarity protection applications.

ABSOLUTE RATINGS (limiting values)

Symbol	Parameter		Value	Unit	
V _{RRM}	Repetitive peak reverse voltage		45	V	
I _{F(RMS)}	RMS forward current		30	A	
I _{F(AV)}	Average forward current δ = 0.5	TO-220AC, I ² PAK, D ² PAK	T _c = 155°C	15	A
		ISOWATT220AC TO-220FPAC	T _c = 130°C		
I _{FSM}	Surge non repetitive forward current	tp = 10 ms Sinusoidal	220	A	
I _{RRM}	Repetitive peak reverse current	tp = 2 μs square F = 1kHz	1	A	
I _{RSM}	Non repetitive peak reverse current	tp = 100 μs square	3	A	
P _{ARM}	Repetitive peak avalanche power	tp = 1μs T _j = 25°C	6000	W	
T _{stg}	Storage temperature range		- 65 to + 175	°C	
T _j	Maximum operating junction temperature *		175	°C	
dV/dt	Critical rate of rise of reverse voltage		10000	V/μs	

* : $\frac{dP_{tot}}{dT_j} < \frac{1}{R_{th}(j-a)}$ thermal runaway condition for a diode on its own heatsink

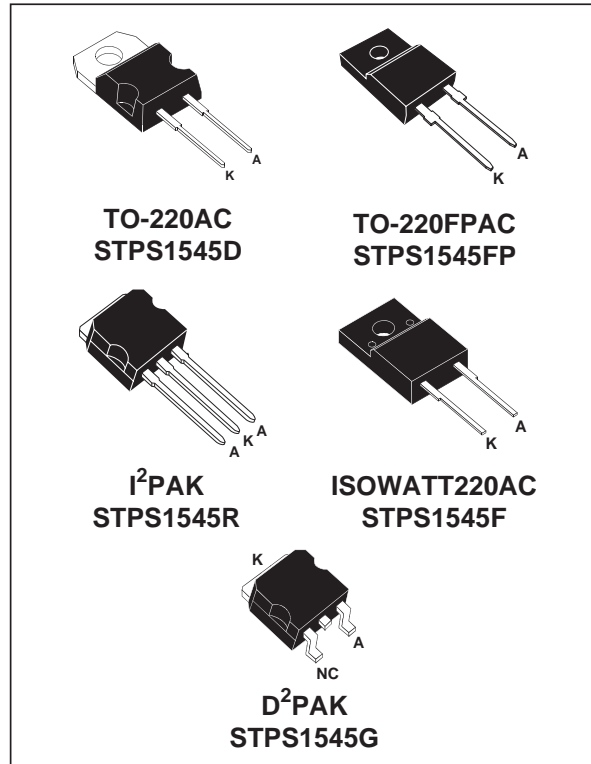

STPS1545D/F/FP/R/G

THERMAL RESISTANCES

Symbol	Parameter	Value	Unit
$R_{th(j-c)}$	Junction to case	TO-220AC, I ² PAK, D ² PAK	1.6
		ISOWATT220AC TO-220FPAC	4.0

STATIC ELECTRICAL CHARACTERISTICS

Symbol	Parameter	Tests Conditions	Min.	Typ.	Max.	Unit	
I_R^*	Reverse leakage current	$T_j = 25^\circ\text{C}$	$V_R = V_{RRM}$		200	μA	
		$T_j = 125^\circ\text{C}$		11	40	mA	
V_F^*	Forward voltage drop	$T_j = 125^\circ\text{C}$	$I_F = 15\text{ A}$		0.5	0.57	V
		$T_j = 25^\circ\text{C}$	$I_F = 30\text{ A}$			0.84	
		$T_j = 125^\circ\text{C}$	$I_F = 30\text{ A}$		0.65	0.72	

Pulse test : * $t_p = 380\ \mu\text{s}$, $\delta < 2\%$

To evaluate the conduction losses use the following equation :

$$P = 0.42 \times I_{F(AV)} + 0.01 I_{F(RMS)}^2$$

Fig. 1: Average forward power dissipation versus average forward current.

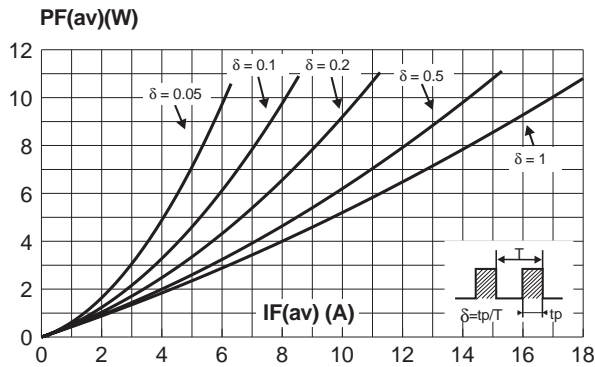

Fig. 3: Normalized avalanche power derating versus pulse duration.

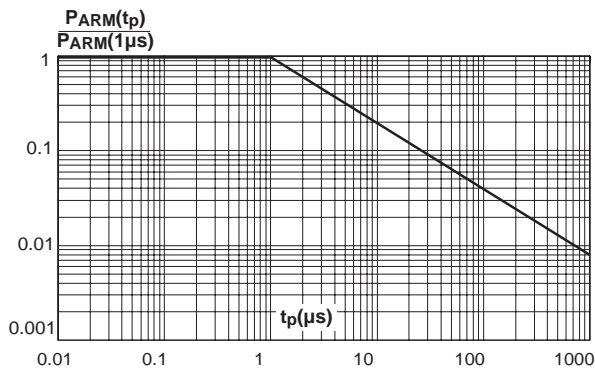

Fig. 2: Average current versus ambient temperature ($\delta = 0.5$).

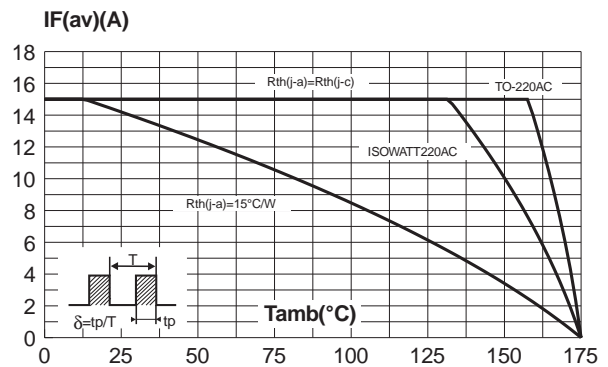

Fig. 4: Normalized avalanche power derating versus junction temperature.

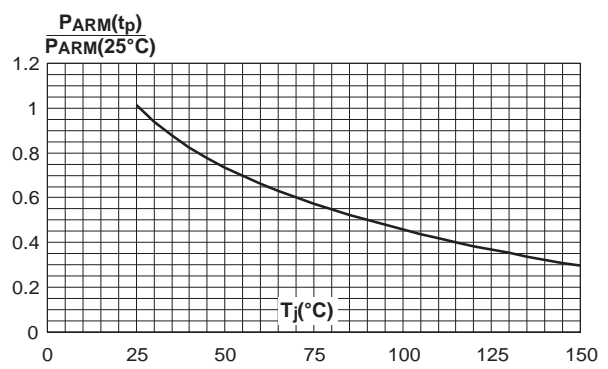

Fig. 5-1: Non repetitive surge peak forward current versus overload duration (maximum values) (TO-220AC, I²PAK and D²PAK).

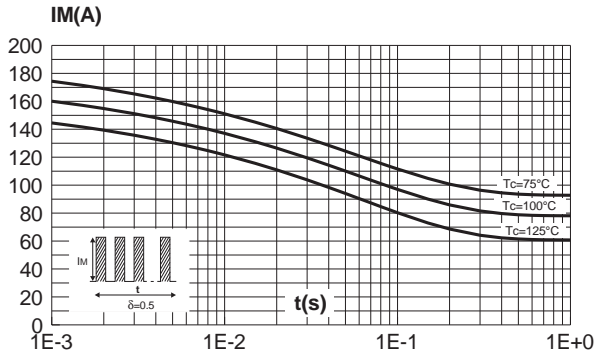

Fig. 5-2: Non repetitive surge peak forward current versus overload duration (maximum values) (ISOWATT220AC, TO-220FPAC).

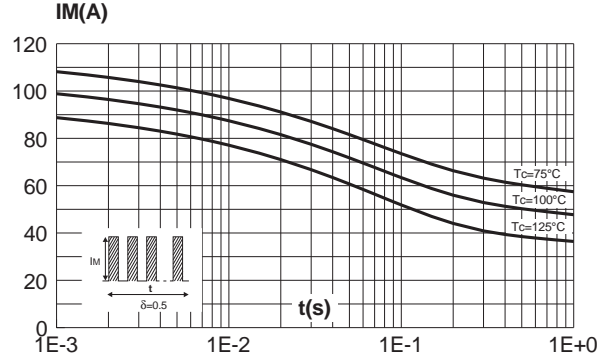

Fig. 6-1: Relative variation of thermal transient impedance junction to case versus pulse duration (TO-220AC, I²PAK and D²PAK).

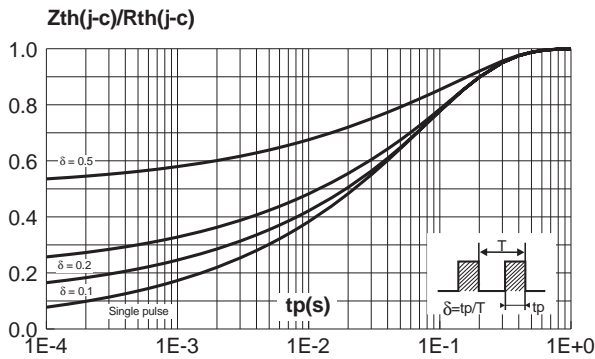

Fig. 6-2: Relative variation of thermal transient impedance junction to case versus pulse duration (ISOWATT220AC, TO-220FPAC).

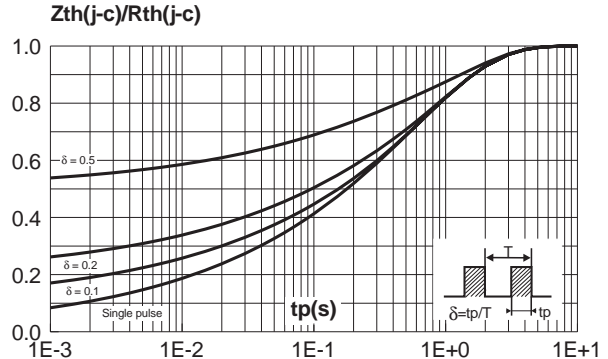

Fig. 7: Reverse leakage current versus reverse voltage applied (typical values).

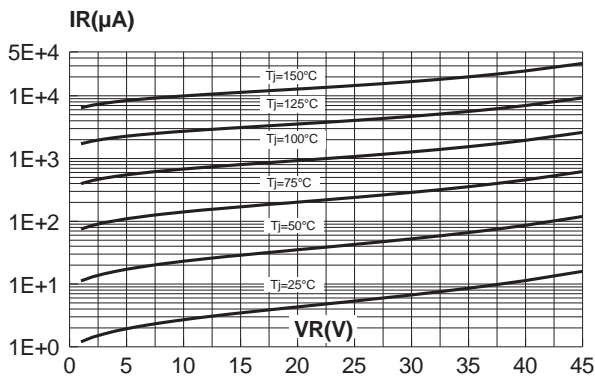

Fig. 8: Junction capacitance versus reverse voltage applied (typical values).

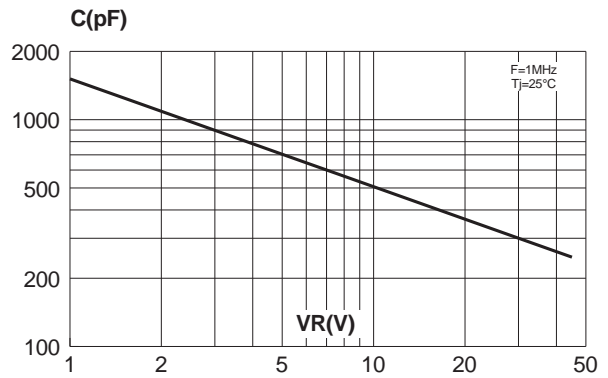

Fig. 9: Forward voltage drop versus forward current (maximum values).

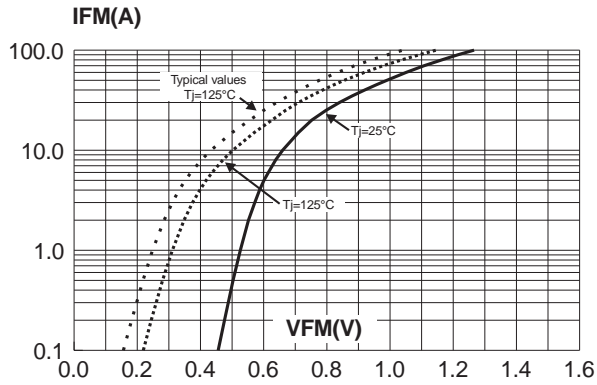
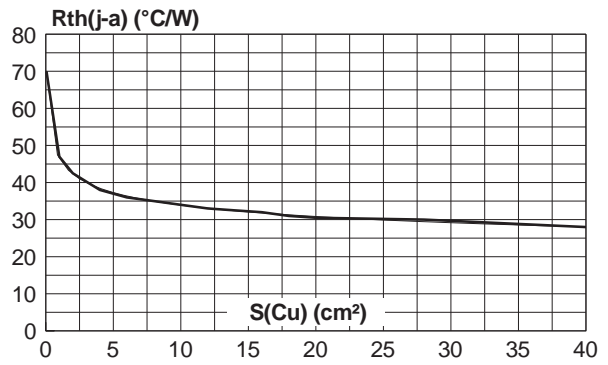
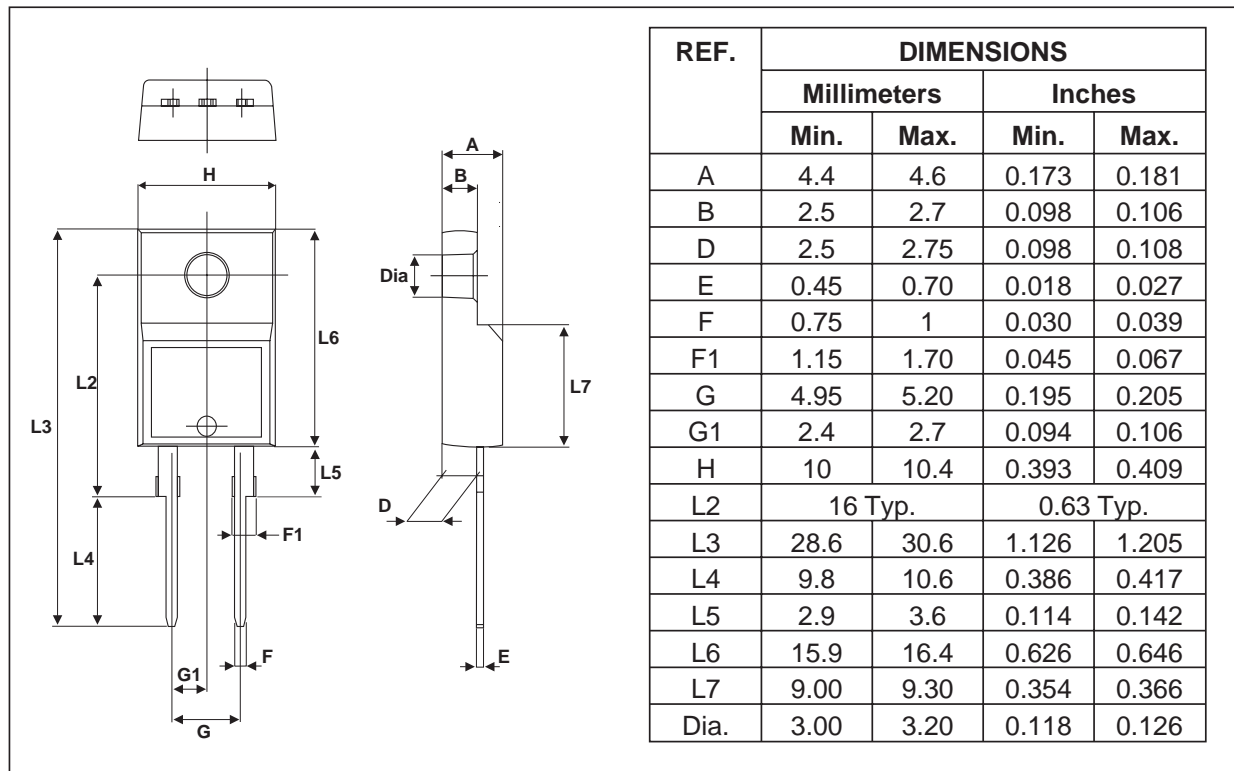

Fig. 10: Thermal resistance junction to ambient versus copper surface under tab (epoxy printed circuit board FR4, Cu=35µm) (D²PAK).



PACKAGE MECHANICAL DATA
TO-220FPAC



PACKAGE MECHANICAL DATA
ISOWATT220AC

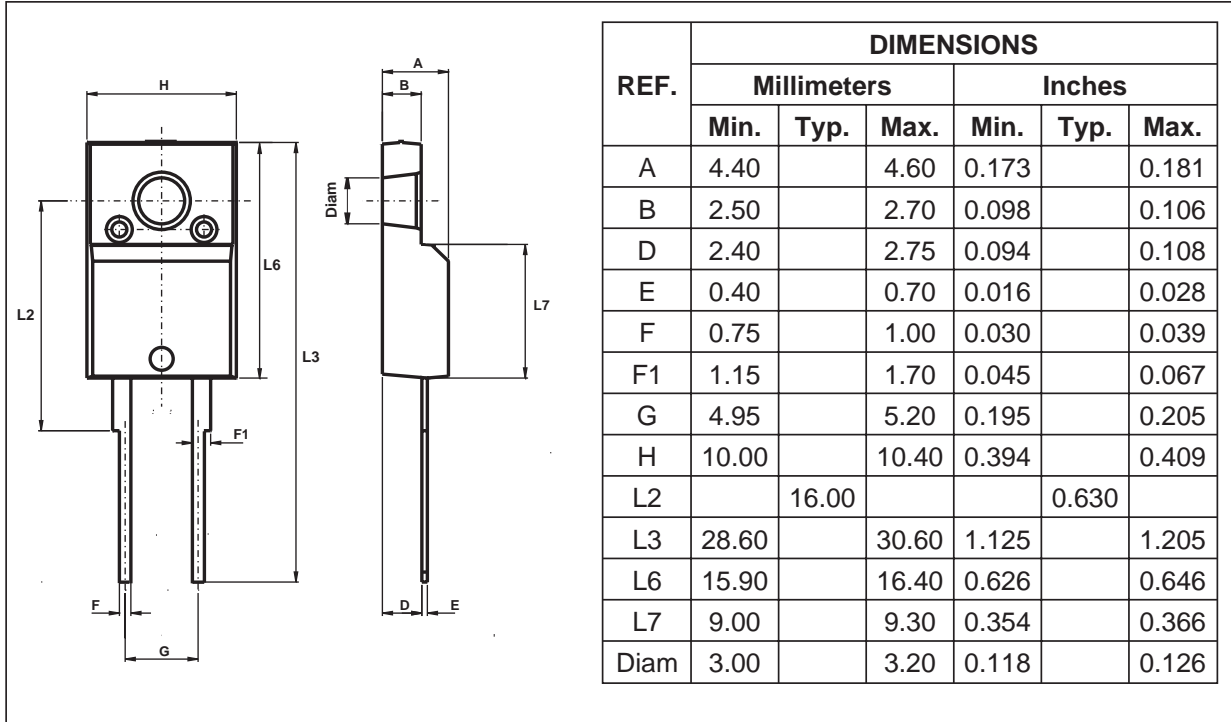

PACKAGE MECHANICAL DATA
I²PAK

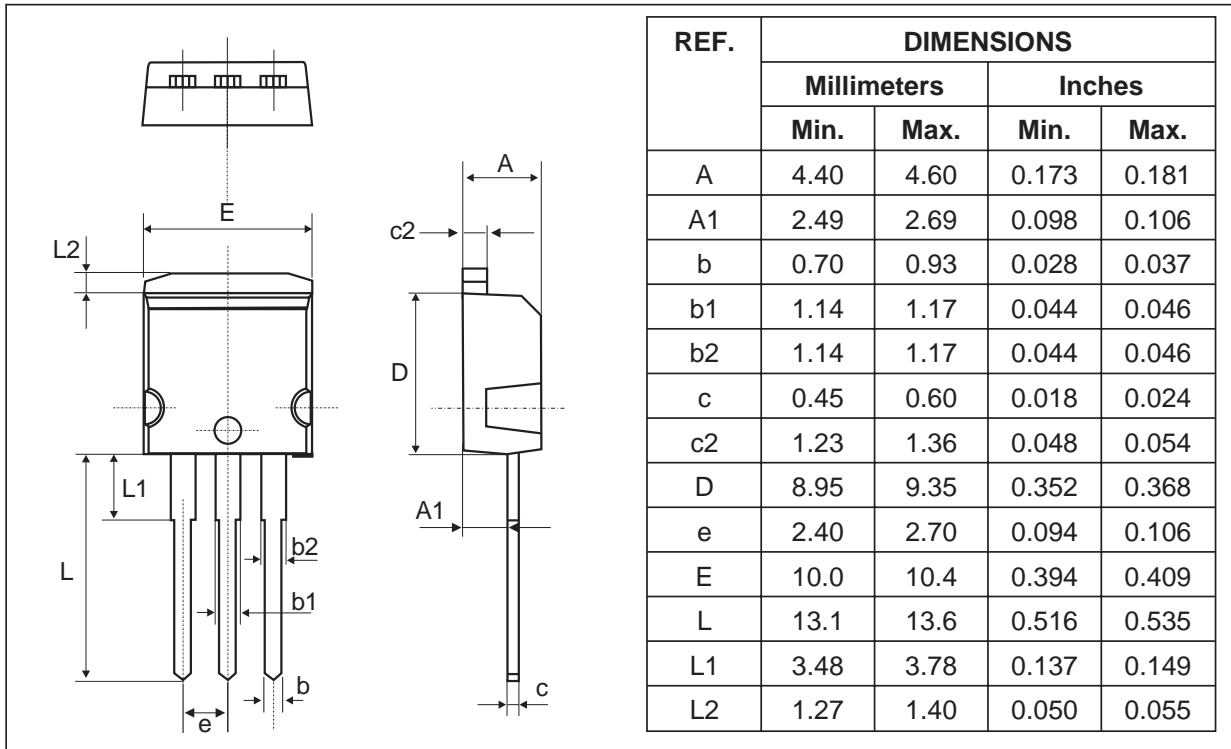

STPS1545D/F/FP/R/G

PACKAGE MECHANICAL DATA
D²PAK

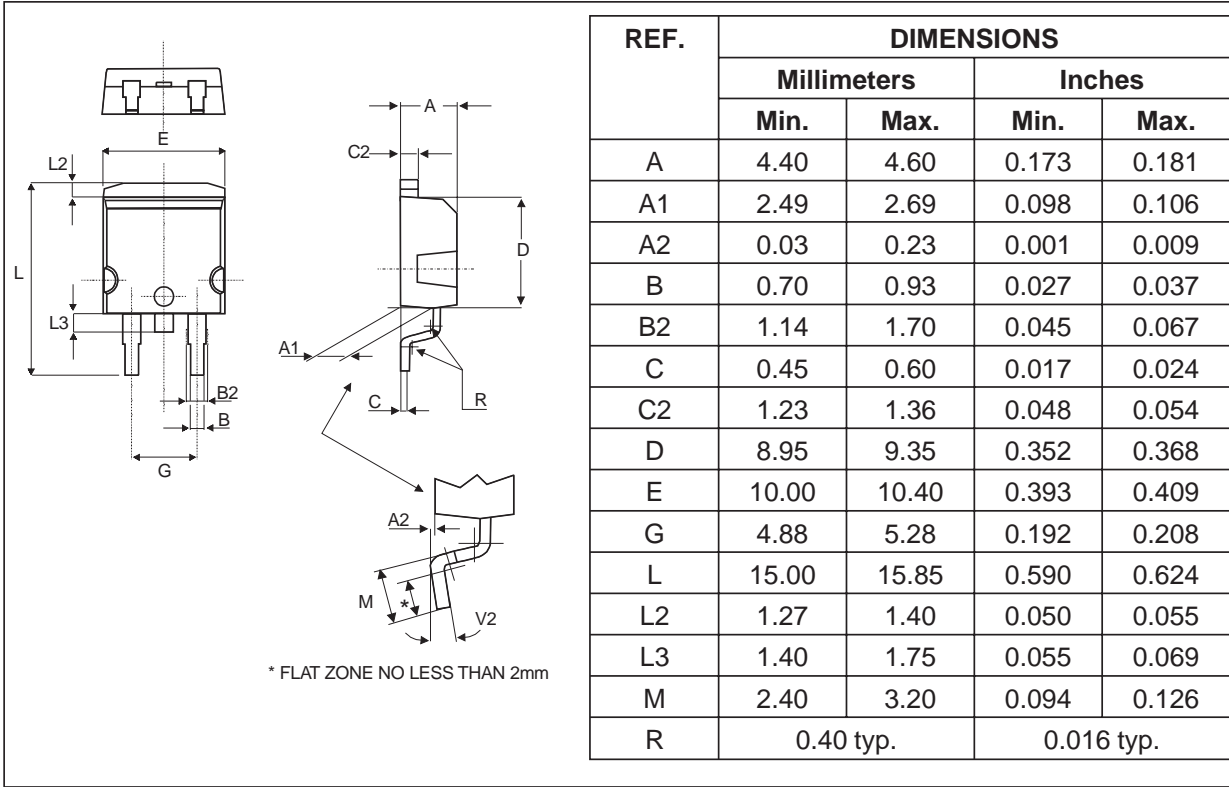

FOOT PRINT DIMENSIONS (in millimeters)

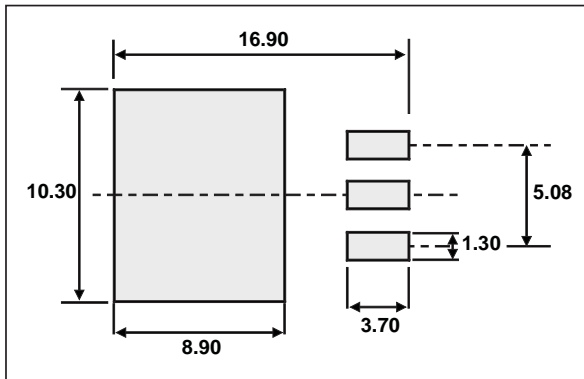

PACKAGE MECHANICAL DATA
 TO-220AC

REF.	DIMENSIONS			
	Millimeters		Inches	
	Min.	Max.	Min.	Max.
A	4.40	4.60	0.173	0.181
C	1.23	1.32	0.048	0.051
D	2.40	2.72	0.094	0.107
E	0.49	0.70	0.019	0.027
F	0.61	0.88	0.024	0.034
F1	1.14	1.70	0.044	0.066
G	4.95	5.15	0.194	0.202
H2	10.00	10.40	0.393	0.409
L2	16.40 typ.		0.645 typ.	
L4	13.00	14.00	0.511	0.551
L5	2.65	2.95	0.104	0.116
L6	15.25	15.75	0.600	0.620
L7	6.20	6.60	0.244	0.259
L9	3.50	3.93	0.137	0.154
M	2.6 typ.		0.102 typ.	
Diam. I	3.75	3.85	0.147	0.151

Type	Marking	Package	Weight	Base qty	Delivery mode
STPS1545D	STPS1545D	TO-220AC	1.86 g	50	Tube
STPS1545F	STPS1545F	ISOWATT220AC	2.0 g	50	Tube
STPS1545FP	STPS1545FP	TO-220FPAC	1.9 g	50	Tube
STPS1545R	STPS1545R	I ² PAK	1.7 g	50	Tube
STPS1545G	STPS1545G	D ² PAK	1.48 g	50	Tube
STPS1545G-TR	STPS1545G	D ² PAK	1.48 g	1000	Tape & Reel

- Cooling method: by conduction (C)
- Recommended torque value: 0.55 N.m.
- Maximum torque value: 0.7 N.m.
- Epoxy meets UL94,V0

Information furnished is believed to be accurate and reliable. However, STMicroelectronics assumes no responsibility for the consequences of use of such information nor for any infringement of patents or other rights of third parties which may result from its use. No license is granted by implication or otherwise under any patent or patent rights of STMicroelectronics. Specifications mentioned in this publication are subject to change without notice. This publication supersedes and replaces all information previously supplied. STMicroelectronics products are not authorized for use as critical components in life support devices or systems without express written approval of STMicroelectronics.

The ST logo is a registered trademark of STMicroelectronics
 © 2003 STMicroelectronics - Printed in Italy - All rights reserved.

STMicroelectronics GROUP OF COMPANIES
 Australia - Brazil - Canada - China - Finland - France - Germany
 Hong Kong - India - Israel - Italy - Japan - Malaysia - Malta - Morocco - Singapore
 Spain - Sweden - Switzerland - United Kingdom - United States.

<http://www.st.com>

