

PSD (POSITION SENSITIVE DETECTOR)

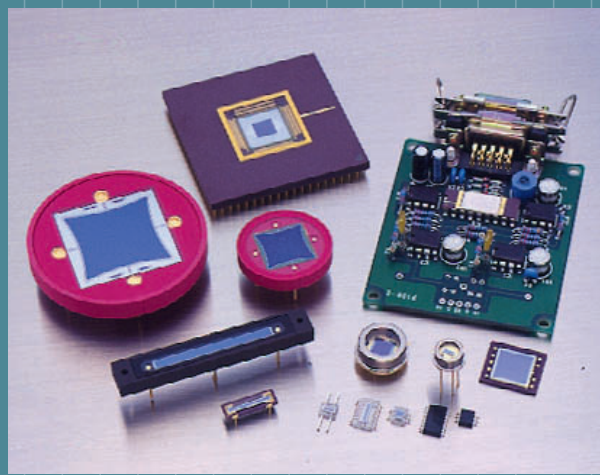

HAMAMATSU

PSD

Position Sensitive Detector

What is PSD?

Various methods are available for detecting the position of incident light. These include methods using small discrete detector arrays or multi-element sensors such as CCD sensors. In contrast to these sensors, PSDs (Position Sensitive Detectors) are comprised of a monolithic detector with no discrete elements and provide continuous position data by making use of the surface resistance of the photodiode. PSDs offer advantages such as high position resolution, high-speed response and reliability.

■ Features of PSD

- Excellent position resolution
- Wide spectral response range
- High-speed response
- Detects center-of-gravity position of spot light
- Simultaneously detects light intensity and center-of-gravity position of spot light
- High reliability

■ Applications of PSD

- Position and angle sensing
- Distortion and vibration measurements
- Lens reflection and refraction measurements
- Laser displacement sensing
- Optical remote control
- Optical range finders
- Optical switches
- Camera auto focusing

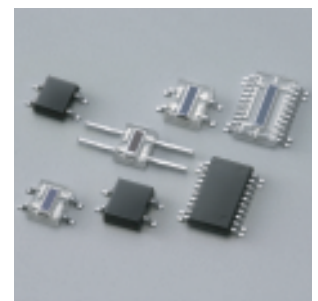
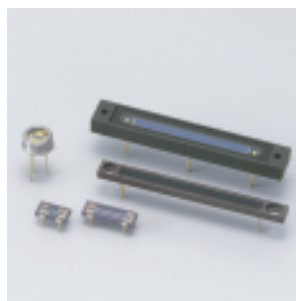
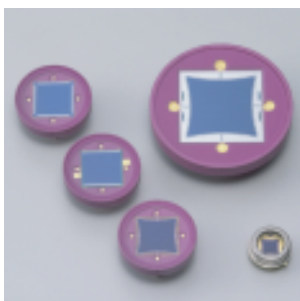

PSD (POSITION SENSITIVE DETECTOR)

CONTENTS

Selection guide	1
Description of terms	4
Characteristic and use	5
1. Basic Principle	5
2. One-dimensional PSD	5
3. Two-dimensional PSD	5
4. Position detection error	7
5. Position resolution	8
6. Response speed	10
7. Saturation photocurrent	11

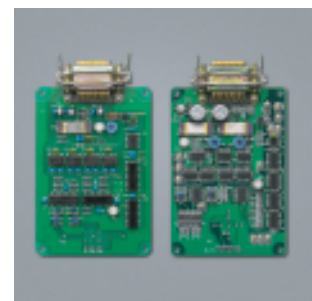
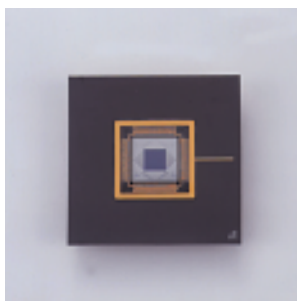
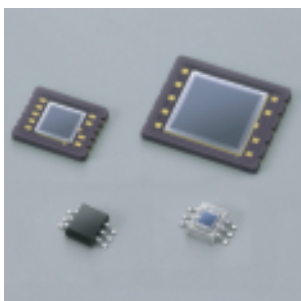

Selection guide

PSD (Position Sensitive Detector) is an optoelectronic position sensor utilizing photodiode surface resistance. Unlike discrete element detectors such as CCD, PSD provides continuous position data (X or Y coordinate data) and features high position resolution and high-speed response.

One-dimensional PSD

Hamamatsu provides various types of one-dimensional PSDs designed for high-precision distance measurement such as displacement meters, camera auto focusing and optical switches. Our product line includes a visible-cut type for near infrared detection, a red sensitivity enhanced type for red light detection, a microscopic spot light (LD beam, etc.) detection type, and a long, narrow type with an active area exceeding 30 mm.

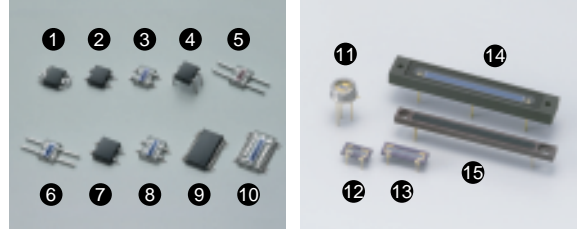

Type No.	Active area (mm)	Resistance length (mm)	Interelectrode resistance V _b =0.1 V (kΩ)	Spectral response range (nm)	Package	
S6407	1 × 1	1	200	760 to 1100	Plastic	
S6515	1 × 1.2	1.2	140	760 to 1100		
S4580-04	0.8 × 1.5	1.5	140	760 to 1100		
S4580-06				320 to 1100		
S4581-04	1 × 2	2	140	760 to 1060		
S4581-06				320 to 1060		
S3271-05	1 × 2.5	2.5	400	760 to 1060		
S4582-04			140	760 to 1100		
S4582-06			140	320 to 1100		
S3272-05			400	760 to 1100		
S4583-04	1 × 3	3	140	760 to 1100		
S4583-06				320 to 1100		
S3273-05			400	760 to 1100		
★ S7879			110	440 to 1100		
★ S8361 *	110	400 to 1100	1 × 3.5	3.5		
S4584-04	140	760 to 1100				
S4584-06	140	320 to 1100				
S3274-05	400	760 to 1100				
S7105-04	1 × 4.2	4.2	140	760 to 1100		
S7105-06				320 to 1100		
S7105-05				400		760 to 1100
S5629	1 × 6	6	50	760 to 1100		
S5629-01				320 to 1100		
S5629-02				300		760 to 1100
S3979	1 × 3	3	140	320 to 1100		TO-5
S3931	1 × 6	6	50	320 to 1100		Ceramic
S3932	1 × 12	12	50	320 to 1100		
★ S1352	2.5 × 34	34	20	320 to 1100		
★ S3270	1 × 37	37	15	700 to 1100		

* High sensitivity in the red region type

★ Works with microscopic spot light detection.

Two-dimensional PSD

Two-dimensional PSDs are classified by structure into a tetra-lateral type and a duo-lateral type. The tetra-lateral type features high-speed response and low dark current. The duo-lateral type offers small position detection error and high position resolution. A pin-cushion type, which is a tetra-lateral type with improved active area and electrodes, has a position detection error as small as the duo-lateral type while still having the advantages of the tetra-lateral type.

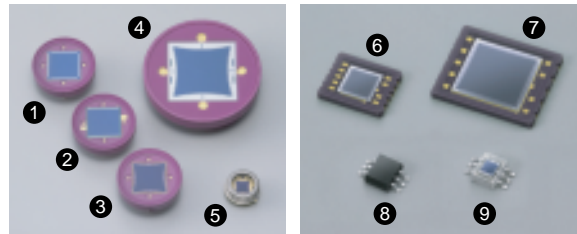

(Typ.)

Type No.	Active area (mm)	Resistance length (mm)	Interelectrode resistance Vb=0.1 V (kΩ)	Spectral response range (nm)	Structure	Package
★ S1200	13 × 13	13 × 13	10	320 to 1060	Tetra-lateral type	Ceramic
★ S1300				320 to 1100	Duo-lateral type	
★ S1880	12 × 12	14 × 14	10	320 to 1060	Pin-cushion type (improved tetra-lateral type)	Ceramic
★ S1881	22 × 22	26 × 26	10		Pin-cushion type (improved tetra-lateral type)	
★ S2044	4.7 × 4.7	5.7 × 5.7	10	320 to 1060	Pin-cushion type (improved tetra-lateral type)	Metal
S5990-01	4 × 4	4.5 × 4.5	7	320 to 1100	Pin-cushion type (improved tetra-lateral type)	Ceramic chip carrier
S5991-01	9 × 9	10 × 10	7		Pin-cushion type (improved tetra-lateral type)	
S7848	2 × 2	2 × 2	100	760 to 1100	Tetra-lateral type	Plastic
S7848-01				320 to 1100		

★ Works with microscopic spot light detection

Examples of position detectability (Ta=25 °C, λ=890 nm, spot light size: φ200 μm)

●S1200

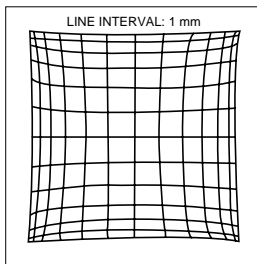

KPSC0017EA

●S1300

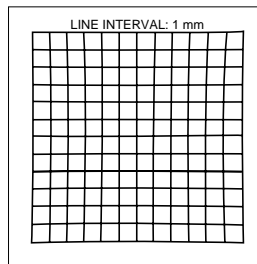

KPSC0015EA

●S1880

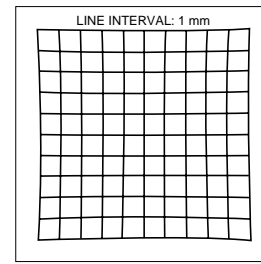

KPSC0020EA

●S5991-01

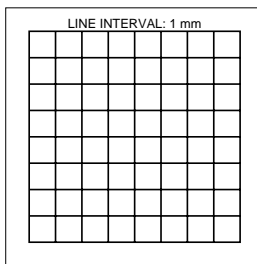

KPSC0065EA

●S7848

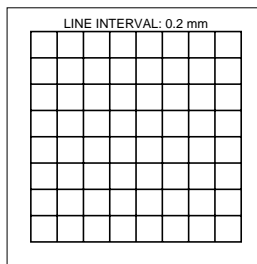

KPSC0084EA

128-element PSD array

S5681 is a 128-element PSD linear array. By scanning a slit-form light beam right and left based on the slit light projection method, S5681 allows measuring a 3-D shape of the object.

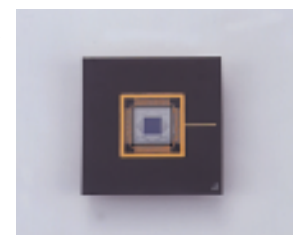

(Typ.)

Type No.	Active area (mm)	Resistance length (mm)	Interelectrode resistance Vb=0.1 V (kΩ)	Spectral response range (nm)	Package
S5681	0.025 × 6.375/128 elements	6.375	100	320 to 1100	Ceramic

PSD signal processing circuit

Features

- No complicated adjustments required
Position measurements can be made by just connecting to a PSD and power supply (± 15 V).
- The position (mm) of a spot light from the PSD center is obtained as an output voltage (V).
(except C3683-01)
- Stable position detection
Accurate position data can be detected independent of incident light intensity.
- Compact size
Head amplifiers, signal addition/subtraction circuits, and analog divider are mounted on a compact PC board.

DC signal processing circuit

Designed specifically for DC light detection.

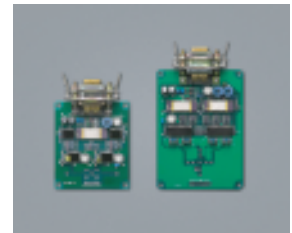

Type No.	PSD type	Dimensional outline (mm)
C3683-01	1-D PSD	66 × 56 × 15
C4674	Pin-cushion type 2-D PSD	90 × 65 × 15
C4757	Duo-lateral type 2-D PSD	92 × 70 × 15
C4758	Tetra-lateral type 2-D PSD	90 × 65 × 15

AC signal processing circuit

Designed specifically for pulse (AC) signal detection.
Has a synchronous circuit, S/H (sample & hold) circuit and LED driver circuit.
Use of a pulse-driven LED ensures reliable operation even under background light.

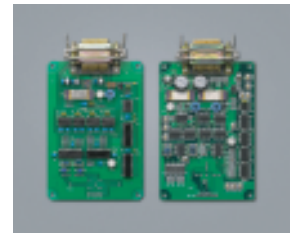

Type No.	PSD type	LED repetition frequency * (kHz)	Dimensional outline (mm)
C5923	1-D PSD	3.3	110 × 75 × 15
C7563	Pin-cushion type 2-D PSD	0.33	110 × 75 × 15

* Can not be modulated.

Description of terms

1. Spectral response

The photocurrent produced by a given level of incident light varies with the wavelength. This relation between the photoelectric sensitivity and wavelength is referred to as the spectral response characteristic and is expressed in terms of photo sensitivity, quantum efficiency, etc.

2. Photo sensitivity: S

This measure of sensitivity is the ratio of radiant energy expressed in watts (W) incident on the device, to the resulting photocurrent expressed in amperes (A). It may be represented as either an absolute sensitivity (A/W) or as a relative sensitivity normalized for the sensitivity at the peak wavelength, usually expressed in percent (%) with respect to the peak value. For the purpose of our PSD data sheets (separately available), the photo sensitivity is represented as the absolute sensitivity, and the spectral response range is defined as the region in which the relative sensitivity is higher than 5 % of the peak value.

3. Quantum efficiency: QE

The quantum efficiency is the number of electrons or holes that can be detected as a photocurrent divided by the number of the incident photons. This is commonly expressed in percent (%). The quantum efficiency and photo sensitivity S have the following relationship at a given wavelength (nm):

$$QE = \frac{S \times 1240}{\lambda} \times 100 [\%]$$

λ : Wavelength (nm)

S: Photo sensitivity at wavelength λ (A/W)

4. Resistance length: L

This is the distance between electrodes on a PSD and is used to calculate the position from the PSD outputs. The resistance length is equivalent to the active area size, except for the pin-cushion type (improved tetra-lateral type) whose resistance length is expressed by the distance actually used to calculate the position.

5. Position detection error

If a light beam strikes the electrical center of a PSD, the signal currents extracted from the output electrodes are equal. When this electrical center is viewed as the origin, the position detection error is defined as the difference between the position at which the light is actually incident on the PSD and the position calculated from the PSD outputs. Measurement conditions for position detection error are as follows:

Light source : $\lambda=890$ nm
Incident spot light: $\phi 200$ μ m
Photocurrent : 10 μ A

6. Position resolution: ΔR

This is the minimum detectable displacement of a spot light incident on a PSD, and is expressed as a distance on the PSD surface. Resolution is mainly determined by the S/N and given by "resistance length \times noise / signal". The resolution values listed in our PSD data sheets (separately available) are calculated based on the RMS values for noise measured under the following conditions.

- Interelectrode resistance: Typical value
(listed in the data sheets)
- Photocurrent : 1 μ A
- Frequency bandwidth : 1 kHz
- Equivalent noise input voltage to circuit: 1 μ V

7. Interelectrode resistance: R_{ie}

This is the resistance between opposing electrodes in a dark state. The interelectrode resistance is an important factor that determines the response speed, position resolution and saturation photocurrent.

The interelectrode resistance is measured with 0.1 V applied across the opposing electrodes and the common electrode left open. When measuring the interelectrode resistance of two-dimensional PSDs, the output electrodes other than the opposing electrodes under measurement are left open.

8. Dark current: I_D

When a reverse voltage is applied to a PSD, a slight current flows even in a dark state. This is termed the dark current and is a source of noise. The dark current listed in our PSD data sheets (separately available) are the total dark current values measured from all output electrodes.

9. Terminal capacitance: C_t

A capacitor is formed at the PN junction of a PSD and its capacitance is called the junction capacitance. The terminal capacitance is the sum of the junction capacitance plus the package stray capacitance, and is a factor in determining the response speed. The terminal capacitance listed in our PSD data sheets are the total capacitance values measured from all output electrodes.

10. Rise time: t_r

The rise time is defined as the time required for the PSD output to rise from 10 to 90 % of the steady output level, when a step function light is input to the PSD. The rise time depends on the incident light wavelength, load resistance, light incident position and reverse voltage, and is measured under the following conditions.

- Light source : $\lambda=890$ nm
- Incident spot light : $\phi 1$ mm
- Incident light position: Center point of PSD
- Load resistance : 1 k Ω
(connected to all output electrodes)

11. Saturation photocurrent: I_{st}

This is the maximum photocurrent value obtained from a PSD as long as it still functions as a position sensor. This value depends on the reverse voltage and interelectrode resistance, and is defined as the total photocurrent when the entire active area is illuminated.

12. Maximum reverse voltage: V_R Max.

Increasing the reverse voltage applied to a PSD can cause it to breakdown at a certain level and result in severe deterioration of PSD performance. To avoid this, the maximum reverse voltage is specified as the absolute maximum rating (this value must not be exceeded even momentarily) at a reverse voltage somewhat lower than the breakdown voltage.

1. Basic principle

A PSD basically consists of a uniform resistive layer formed on one or both surfaces of a high-resistivity semiconductor substrate, and a pair of electrodes formed on both ends of the resistive layer for extracting position signals. The active area, which is also a resistive layer, has a PN junction that generates photocurrent by means of the photovoltaic effect.

Figure 1-1 PSD sectional view

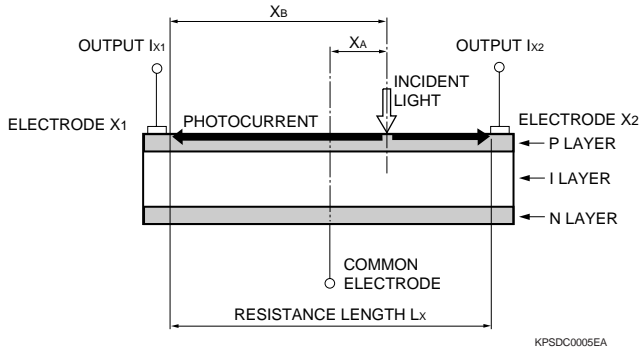

Figure 1-1 shows a sectional view of a PSD using a simple illustration to explain the operating principle. The PSD has a P-type resistive layer formed on an N-type high-resistive silicon substrate. This P-layer serves as an active area for photoelectric conversion and a pair of output electrodes are formed on the both ends of the P-layer. On the backside of the silicon substrate is an N-layer to which a common electrode is connected. Basically, this is the same structure as that of PIN photodiodes except for the P-type resistive layer on the surface.

When a spot light strikes the PSD, an electric charge proportional to the light intensity is generated at the incident position. This electric charge is driven through the resistive layer and collected by the output electrodes X1 and X2 as photocurrents, while being divided in inverse proportion to the distance between the incident position and each electrode.

The relation between the incident light position and the photocurrents from the output electrodes X1, X2 is given by the following formulas.

● When the center point of PSD is set at the origin:

$$I_{X1} = \frac{Lx - X_A}{Lx} \times I_o \dots\dots\dots (1-1) \quad I_{X2} = \frac{Lx + X_A}{Lx} \times I_o \dots\dots\dots (1-2)$$

$$\frac{I_{X2} - I_{X1}}{I_{X1} + I_{X2}} = \frac{2X_A}{Lx} \dots\dots\dots (1-3) \quad \frac{I_{X1}}{I_{X2}} = \frac{Lx - 2X_A}{Lx + 2X_A} \dots\dots\dots (1-4)$$

● When the end of PSD is set at the origin:

$$I_{X1} = \frac{Lx - X_B}{Lx} \cdot I_o \dots\dots\dots (1-5) \quad I_{X2} = \frac{X_B}{Lx} \cdot I_o \dots\dots\dots (1-6)$$

$$\frac{I_{X2} - I_{X1}}{I_{X1} + I_{X2}} = \frac{2X_B - Lx}{Lx} \dots\dots\dots (1-7) \quad \frac{I_{X1}}{I_{X2}} = \frac{Lx - X_B}{X_B} \dots\dots\dots (1-8)$$

- I_o : Total photocurrent ($I_{X1} + I_{X2}$)
- I_{X1} : Output current from electrode X1
- I_{X2} : Output current from electrode X2
- Lx : Resistance length (length of the active area)
- X_A : Distance from the electrical center of PSD to the light input position
- X_B : Distance from the electrode X1 to the light input position

By finding the difference or ratio of I_{X1} to I_{X2} , the light input position can be obtained by the formulas (1-3), (1-4), (1-7) and (1-8) irrespective of the incident light intensity level and its changes. The light input position obtained here corresponds to the center-of-gravity of the light beam.

2. One-dimensional PSD

Figure 2-1 Structure chart, equivalent circuit (one-dimensional PSD)

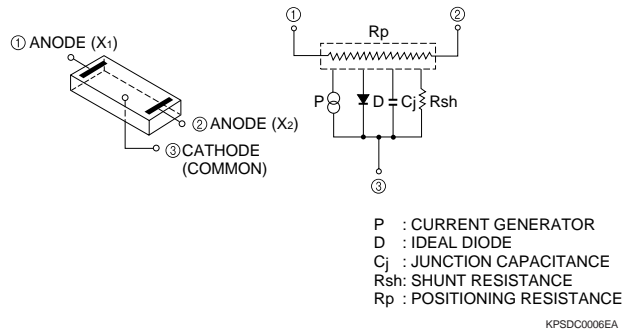
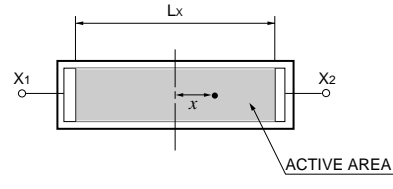

Figure 2-2 Active area chart (one-dimensional PSD)



● Position conversion formula (See Figure 2-2.)

$$\frac{I_{X2} - I_{X1}}{I_{X1} + I_{X2}} = \frac{2x}{Lx} \dots\dots\dots (2-1)$$

In the above formula, I_{X1} and I_{X2} are the output currents obtained from the electrodes shown in Figure 2-2.

3. Two-dimensional PSD

Two-dimensional PSDs are grouped by structure into duo-lateral and tetra-lateral types. Among the tetra-lateral type PSDs, a pin-cushion type with an improved active area and electrodes is also provided. (See "3-3".) The position conversion formulas slightly differ according to the PSD structure. Two-dimensional PSDs have two pairs of output electrodes, X1, X2 and Y1, Y2.

3-1 Duo-lateral type PSD

On the duo-lateral type, the N-layer shown in the sectional view of Figure 1-1 is processed to form a resistive layer, and two pair of electrodes are formed on both surfaces as X and Y electrodes arranged at right angles. (See Figure 3-1.) The X position signals are extracted from the X electrodes on the upper surface, while the Y position signals are extracted from the Y electrodes on the bottom surface. As shown in Figure 3-1, a photocurrent with a polarity opposite that of the other surface is on each surface, to produce signal currents twice as large as the tetra-lateral type and achieve a higher position resolution. In addition, when compared to the tetra-lateral type, the duo-lateral type offers excellent position detection characteristics because the electrodes are not in close proximity. The light input position can be calculated from conversion formulas (3-1) and (3-2).

Figure 3-1 Structure chart, equivalent circuit (duo-lateral type PSD)

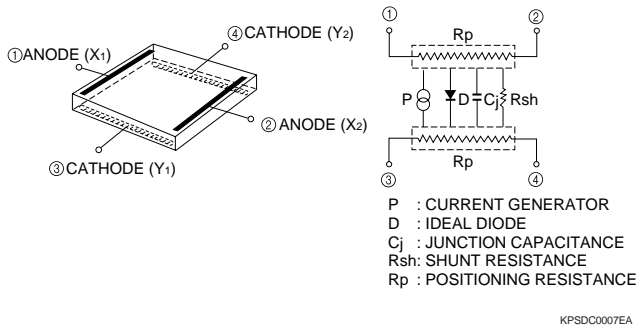

KP5DC0007EA

Figure 3-2 Active area chart (duo-lateral type PSD)

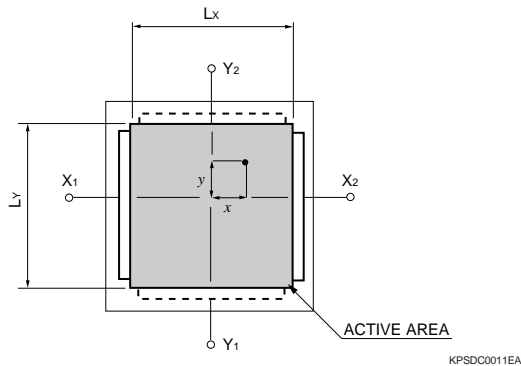

KP5DC0011EA

● Position conversion formula (See Figure 3-2.)

$$\frac{IX_2 - IX_1}{IX_1 + IX_2} = \frac{2x}{Lx} \dots\dots (3-1)$$

$$\frac{IY_2 - IY_1}{IY_1 + IY_2} = \frac{2y}{Ly} \dots\dots (3-2)$$

3-2 Tetra-lateral type PSD

The tetra-lateral type has four electrodes on the upper surface, formed along each of the four edges. Photocurrent is divided into 4 parts through the same resistive layer and extracted as position signals from the four electrodes. Compared to the duo-lateral type, interaction between the electrodes tends to occur near the corners of the active area, making position distortion larger. But the tetra-lateral type features an easy-to-apply reverse bias voltage, small dark current and high-speed response. The light input position for the tetra-lateral type shown in Figure 3-4 is given by conversion formulas (3-3) and (3-4), which are the same as for the duo-lateral type.

Figure 3-3 Structure chart, equivalent circuit (tetra-lateral type PSD)

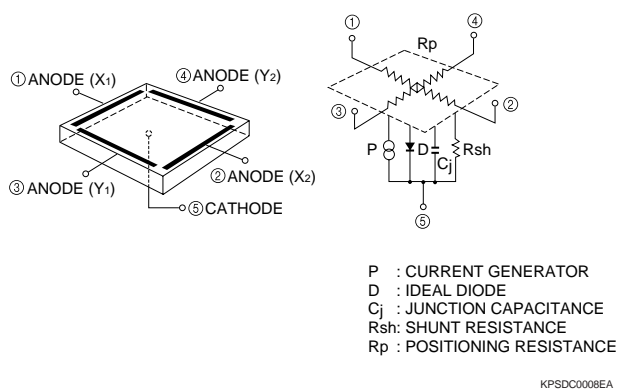

KP5DC0008EA

Figure 3-4 Active area chart (tetra-lateral type PSD)

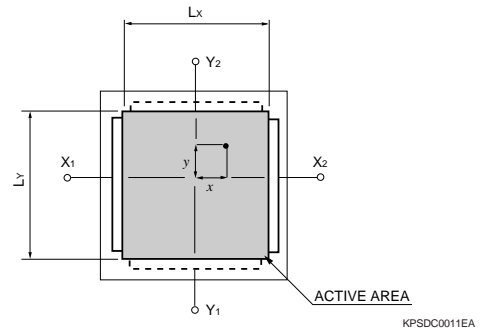

KP5DC0011EA

● Position conversion formula (See Figure 3-4.)

$$\frac{IX_2 - IX_1}{IX_1 + IX_2} = \frac{2x}{Lx} \dots\dots (3-3)$$

$$\frac{IY_2 - IY_1}{IY_1 + IY_2} = \frac{2y}{Ly} \dots\dots (3-4)$$

3-3 Pin-cushion type (improved tetra-lateral type) PSD

This is a variant of the tetra-lateral type PSD with an improved active area and reduced interaction between electrodes. In addition to the advantages of small dark current, high-speed response and easy application of reverse bias that the tetra-lateral type offers, the circumference distortion has been greatly reduced. The light input position of the pin-cushion type shown in Figure 3-6 is calculated from conversion formulas (3-5) and (3-6), which are different from those for the duo-lateral and tetra-lateral types.

Figure 3-5 Structure chart, equivalent circuit (pin-cushion type PSD)

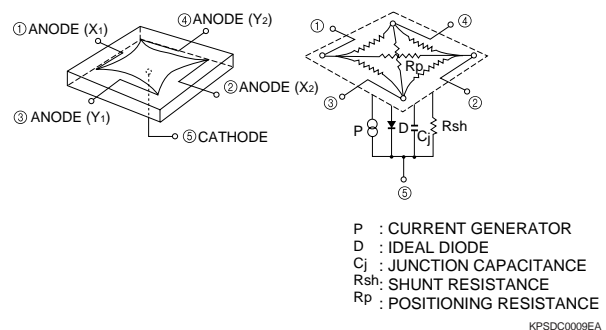

KP5DC0009EA

Figure 3-6 Active area chart (pin-cushion type PSD)

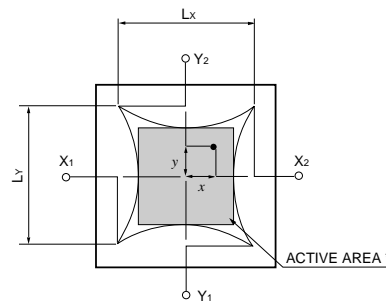

* Active area is specified at the inscribed square.

KP5DC0012EA

● Position conversion formula (See Figure 3-6.)

$$\frac{(IX_2 + IY_1) - (IX_1 + IY_2)}{IX_1 + IX_2 + IY_1 + IY_2} = \frac{2x}{Lx} \dots\dots (3-5)$$

$$\frac{(IX_2 + IY_2) - (IX_1 + IY_1)}{IX_1 + IX_2 + IY_1 + IY_2} = \frac{2y}{Ly} \dots\dots (3-6)$$

4. Position detection error

Position detection capability is the most important characteristic of a PSD. The position of a spot light incident on the PSD surface can be measured by making calculations based on the photocurrent extracted from each electrode. The position obtained here with the PSD is the center-of-gravity of the spot light, and is independent of the spot light size, shape and intensity.

However, the calculated position usually varies slightly in each PSD from the actual position of the incident light. This difference is referred to as the "position detection error" and is explained below.

If a light beam strikes the electrical center of a PSD, the signal currents extracted from the output electrodes are equal. When this electrical center is viewed as the origin, the position detection error is defined as the difference between the position at which the light is actually incident on the PSD and the position calculated from the PSD outputs.

Figure 4-1 Cross section of PSD

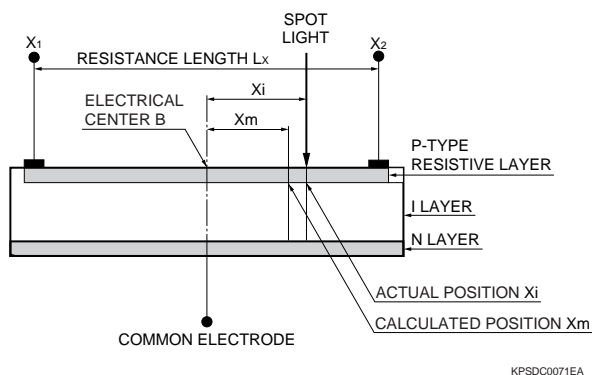

In Figure 4-1 above, if the actual position of incident light is X_i and the position calculated by the photocurrents (I_{X1} and I_{X2}) from electrodes X_1 and X_2 is X_m , then the difference in distance between X_i and X_m is the position detection error as calculated below.

$$\text{Position detection error } E = X_i - X_m \text{ } [\mu\text{m}] \text{ (4-1)}$$

X_i : Actual position of incident light (μm)

X_m : Calculated position of incident light (μm)

$$X_m = \frac{I_{X2} - I_{X1}}{I_{X1} + I_{X2}} \cdot \frac{Lx}{2} \text{ (4-2)}$$

The position detection error is measured under the following conditions.

- Light source : $\lambda=890 \text{ nm}$
- Spot light size : $\phi 200 \mu\text{m}$
- Total photocurrent: $10 \mu\text{A}$
- Reverse voltage : Specified value (listed in data sheets)

Figure 4-2 shows the photocurrent output example from electrodes of a one-dimensional PSD with a resistance length of 3 mm (S4583-04, etc.), measured when a light beam is scanned over the active surface. The position detection error estimated from the obtained data is also shown in the lower graph.

Figure 4-2 Photocurrent output example of one-dimensional PSD (S4583-04, etc.)

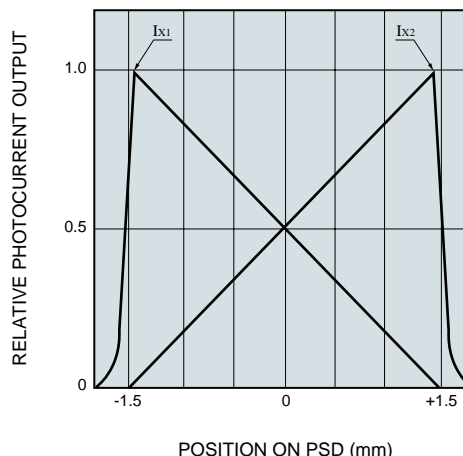

Position detection error example of one-dimensional PSD (S4583-04, etc.)

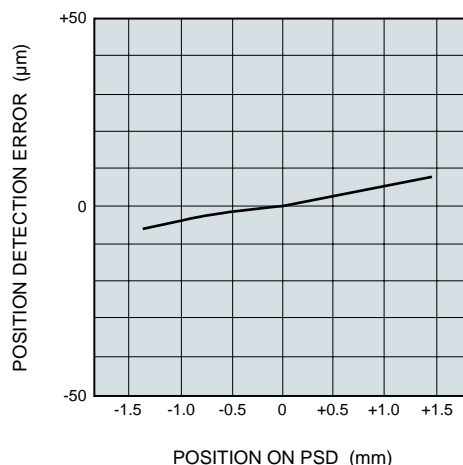

Specific area for position detection error

The light beam position can be detected over the entire active area of PSD. However, if part of the light beam strikes outside the active area, a positional shift in the center-of-gravity occurs between the entire light beam and the light spot falling within the active area, making the position measurement unreliable. It is therefore necessary to select a PSD whose active area matches the incident spot light.

Figure 4-3 Center-of-gravity of incident spot light

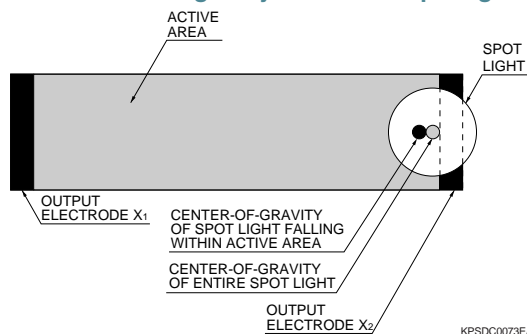

The position detection error is usually measured with a light beam of $\phi 200 \mu\text{m}$, so the specified areas shown in Figures 4-4 to 4-6 are used for position detection error.

Figure 4-4 Specific area for one-dimensional PSD position detection error (resistance length $\leq 12 \text{ mm}$)

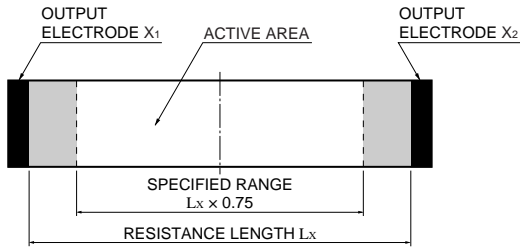

KPSCD0074EA

Figure 4-5 Specific area for one-dimensional PSD position detection error (resistance length $> 12 \text{ mm}$)

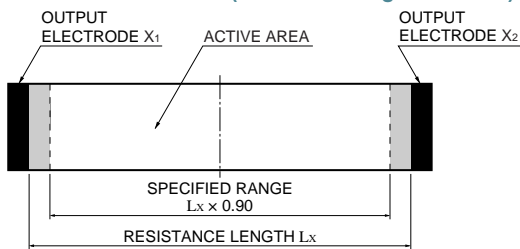

KPSCD0075EA

Figure 4-6 Specific area for two-dimensional PSD position detection error

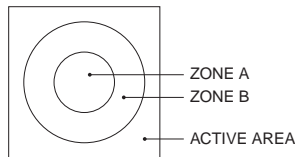

KPSCD0063EA

Position detection error for two-dimensional PSDs is separately measured in two areas: Zone A and Zone B. Two zones are used because position detection error in the circumference is larger than that in the center of the active area,

- Zone A: Within a circle with a diameter equal to 40 % of one side length of the active area.
- Zone B: Within a circle with a diameter equal to 80 % of one side length of the active area.

5. Position resolution

Position resolution is the minimum detectable displacement of a spot light incident on PSD, expressed as a distance on the PSD surface. Resolution is determined by the PSD resistance length and the S/N. Using formula (1-6) as an example, the following equation can be established.

$$IX2 + \Delta I = \frac{XB + \Delta x}{LX} \cdot Io \dots\dots\dots (5-1)$$

Δx : Small displacement

ΔI : Change in output current

Then, Δx can be expressed by the following equation.

$$\Delta x = LX \cdot \frac{\Delta I}{Io} \dots\dots\dots (5-2)$$

In cases where the positional displacement is infinitely small, the noise component contained in the output current $Ix2$ clearly determines the position resolution. Generally, if the PSD noise current is In , then the position resolution ΔR is given as follows:

$$\Delta R = LX \cdot \frac{In}{Io} \dots\dots\dots (5-3)$$

Figure 5-1 shows the basic connection example when using a PSD in conjunction with current-to-voltage amplifiers. The noise model for this circuit is shown in Figure 5-2.

Figure 5-1 Basic connection example of one-dimensional PSD and current-to-voltage conversion type operational amplifier

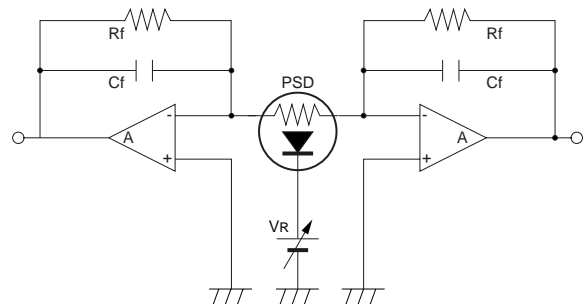

KPSCD0076EA

Figure 5-2 Noise model

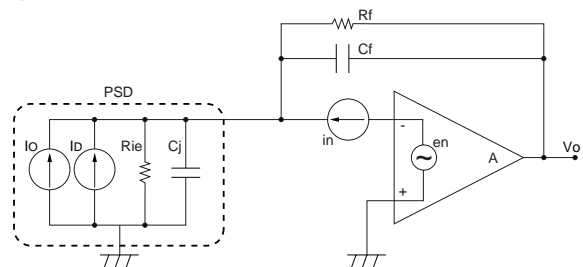

KPSCD0077EA

- I_o : Photocurrent
- I_D : Dark current
- R_{ie} : Interelectrode resistance
- C_j : Junction capacitance
- R_f : Feedback resistance
- C_f : Feedback capacitance
- e_n : Equivalent noise input voltage of operational amplifier
- i_n : Equivalent noise input current of operational amplifier
- V_o : Output voltage

Noise currents are calculated below, assuming that the feedback resistance R_f of the current-to-voltage conversion circuit is sufficiently greater than the PSD interelectrode resistance R_{ie} . In this case, $1/R_f$ can be ignored since it is sufficiently small compared to $1/R_{ie}$. Position resolution as listed in our PSD data sheets is calculated by this method.

- 1) Shot noise current I_s originating from photocurrent and dark current

$$I_s = \sqrt{2q \cdot (I_o + I_D) \cdot B} \text{ [A]} \dots\dots\dots (5-4)$$

q : Electron charge (1.60×10^{-19} C)
 I_o : Signal photocurrent (A)
 I_D : Dark current (A)
 B : Bandwidth (Hz)

- 2) Thermal noise current (Johnson noise current) I_j generated from interelectrode resistance (This can be ignored as $R_{sh} \gg R_{ie}$.)

$$I_j = \sqrt{\frac{4kTB}{R_{ie}}} \text{ [A]} \dots\dots\dots (5-5)$$

k : Boltzmann constant (1.38×10^{-23} J/K)
 T : Absolute temperature (K)
 R_{ie} : Interelectrode resistance (Ω)

- 3) Noise current I_{en} by equivalent noise input voltage of operational amplifier

$$I_{en} = \frac{e_n}{R_{ie}} \sqrt{B} \text{ [A]} \dots\dots\dots (5-6)$$

e_n : Equivalent noise input voltage of operational amplifier ($V/Hz^{1/2}$)

By taking the sum of equations (5-4), (5-5) and (5-6), the PSD noise current can be expressed as an RMS value as follows:

$$I_n = \sqrt{I_s^2 + I_j^2 + I_{en}^2} \text{ [A]} \dots\dots\dots (5-7)$$

If R_f cannot be ignored versus R_{ie} (as a guide, $R_{ie}/R_f > 0.1$), then the equivalent noise output voltage must be taken into account. In this case, equations (5-4), (5-5) and (5-6) are converted into output voltages as follows:

$$V_s = R_f \cdot \sqrt{2q \cdot (I_o + I_D) \cdot B} \text{ [V]} \dots\dots\dots (5-8)$$

$$V_j = R_f \cdot \sqrt{\frac{4kTB}{R_{ie}}} \text{ [V]} \dots\dots\dots (5-9)$$

$$V_{en} = \left(1 + \frac{R_f}{R_{ie}}\right) \cdot e_n \cdot \sqrt{B} \text{ [V]} \dots\dots\dots (5-10)$$

The thermal noise from the feedback resistance and the equivalent noise input current of the operational amplifier are also added as follows:

$$V_{Rf} = R_f \cdot \sqrt{\frac{4kTB}{R_f}} \text{ [V]} \dots\dots\dots (5-11)$$

$$V_{in} = R_f \cdot i_n \cdot \sqrt{B} \text{ [V]} \dots\dots\dots (5-12)$$

The equivalent noise input voltage of the operational amplifier is then expressed as an RMS value by the following equation.

$$V_n = \sqrt{V_s^2 + V_j^2 + V_{en}^2 + V_{Rf}^2 + V_{in}^2} \text{ [V]} \dots\dots\dots (5-13)$$

Figure 5-3 shows the shot noise current plotted along the signal photocurrent value when $R_f \gg R_{ie}$. Figure 5-4 shows the thermal noise current and the noise current by the equivalent noise input voltage of the operational amplifier, plotted along the interelectrode resistance value. When using a PSD with an interelectrode resistance of about $10 \text{ k}\Omega$, the operational amplifier becomes a crucial factor in determining the noise current, so a low-noise-current operational amplifier must be used. When using a PSD with an interelectrode resistance exceeding $100 \text{ k}\Omega$, the thermal noise generated from the interelectrode resistance of the PSD itself will be predominant.

As explained above, PSD position resolution is determined by interelectrode resistance and light intensity. This is the point in which the PSD greatly differs from discrete type position detectors.

The following methods are effective for increasing the PSD position resolution.

- Increase the signal photocurrent I_o .
- Increase the interelectrode resistance R_{ie} .
- Shorten the resistance length L .
- Use a low noise operational amplifier.

The position resolution listed in our PSD data sheets is measured under the following conditions.

- Photocurrent: $1 \mu\text{A}$
- Circuit input noise: $1 \mu\text{V}$ ($31.6 \text{ nV}/\text{Hz}^{1/2}$)
- Frequency bandwidth: 1 kHz

Figure 5-3 Shot noise vs. signal photocurrent

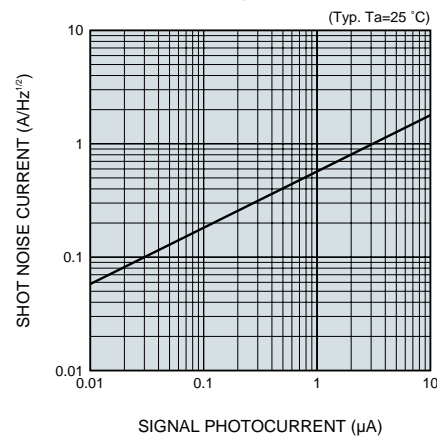

KPSDB0083EA

Figure 5-4 Noise current vs. interelectrode resistance

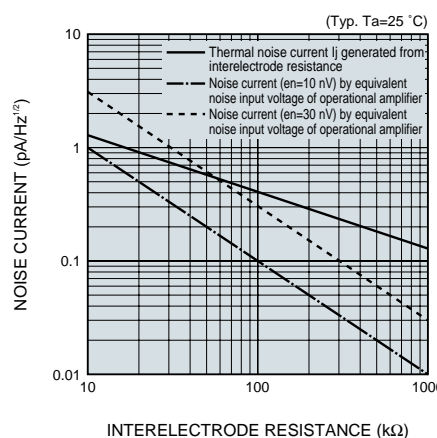

KPSDB0084EA

6. Response speed

As with photodiodes, the response speed of PSD is the time required for the generated carriers to be extracted as current by an external circuit. This is generally expressed as the rise time t_r and is an important parameter when detecting a spot light traveling over the active surface at high speeds or using pulse-modulated light for subtracting the background light. The rise time is defined as the time needed for the output signal to rise from 10 to 90 % of its peak value and is chiefly determined by the following two factors.

- 1) Time constant t_1 determined by the interelectrode resistance, load resistance and terminal capacitance

The interelectrode resistance R_{ie} of PSD basically acts as load resistance R_L , so the time constant t_1 is given by the interelectrode resistance R_{ie} and terminal capacitance C_t , as follows:

$$t_1 = 2.2 \cdot C_t \cdot (R_{ie} + R_L) \dots\dots\dots (6-1)$$

The rise time listed in our PSD datasheets is measured with a spot light striking the center of the active area with the interelectrode resistance R_{ie} distributed between the electrodes. So the time constant t_1 is as follows:

$$t_1 = 0.5 \cdot C_t \cdot (R_{ie} + R_L) \dots\dots\dots (6-2)$$

- 2) Diffusion time t_2 of carriers generated outside the depletion layer

Carriers are also generated outside the depletion layer when light is absorbed in the PSD chip surrounding areas outside the active area or at locations deeper than the depletion layer in the substrate. These carriers diffuse through the substrate and are extracted as an output. The time t_2 required for these carriers to diffuse may be more than several microseconds.

The equation below gives the approximate rise time t_r of a PSD. Figure 6-1 shows typical output waveforms in response to stepped light input.

$$t_r \cong \sqrt{t_1^2 + t_2^2} \dots\dots\dots (6-3)$$

Figure 6-1 Response wavelength example of PSD

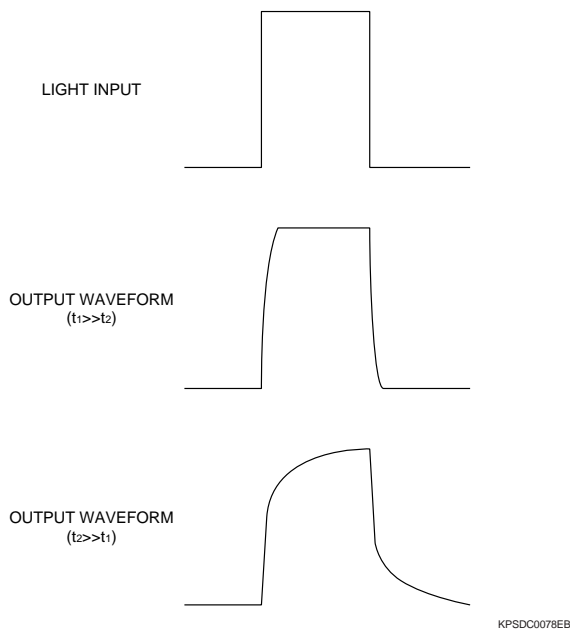
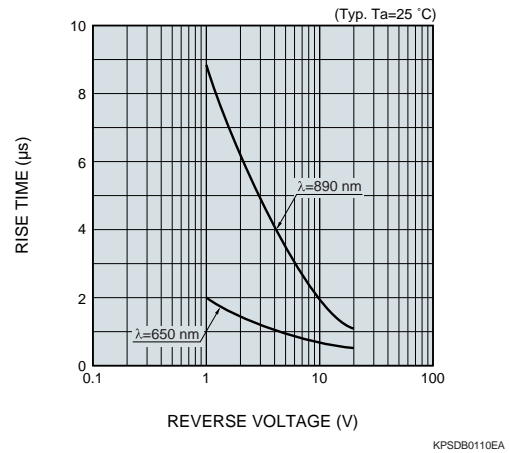

Figure 6-2 shows the relation between the rise time and reverse voltage measured at different wavelengths. The rise time can be reduced by increasing the reverse voltage and using a light beam of shorter wavelengths. Selecting a PSD with a small R_{ie} is also effective in improving the rise time.

Figure 6-2 Rise time vs. reverse voltage (S4583-06)



A method for integrating position signals can be used when detecting pulsed light having a pulse width shorter than the PSD rise time.

7. Saturation photocurrent

Photocurrent saturation must be taken into account when a PSD is used outdoors, in locations where the background light level is high, or the signal light amount is extremely large. Figure 7-1 shows typical photocurrent output of a PSD in a non-saturated state. This PSD is operating normally with good output linearity over the entire active area. If the background light level is excessively high or the signal light amount is extremely large, the PSD photocurrent will saturate. A typical output from a saturated PSD is shown in Figure 7-2. The output linearity of the PSD is impaired so the correct position cannot be detected in this case.

Photocurrent saturation of a PSD depends on the interelectrode resistance and reverse voltage, as shown in Figure 7-3. The saturated photocurrent is measured as the total photocurrent of a PSD when the entire active area is illuminated. If a small spot light is focused on the active area, the photocurrent that is generated is concentrated only on a localized portion, so saturation occurs at a lower level.

- To avoid the saturation effect, use the following methods.
- Reduce the background light level by using an optical filter.
 - Use a PSD with a small active area.
 - Increase the reverse voltage.
 - Decrease the interelectrode resistance.
 - Avoid concentrating the light beam on a small area.

Figure 7-1 Photocurrent output example of PSD in normal operation (S5629)

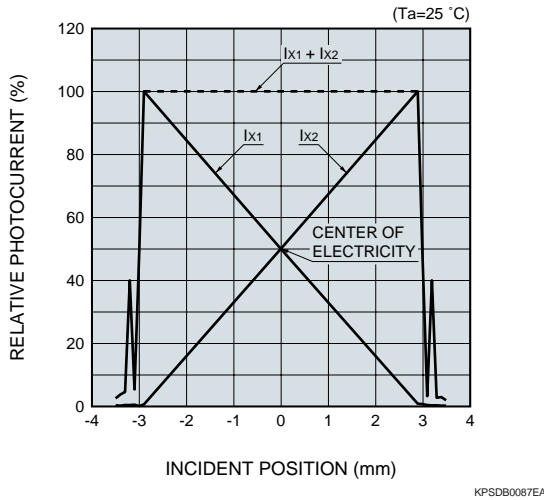

Figure 7-2 Photocurrent output example of saturated PSD (S5629)

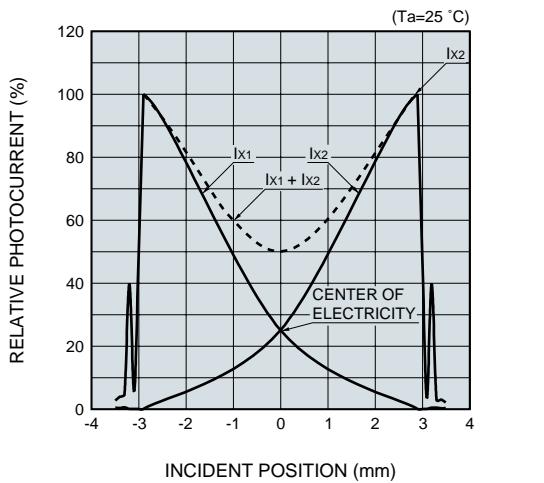
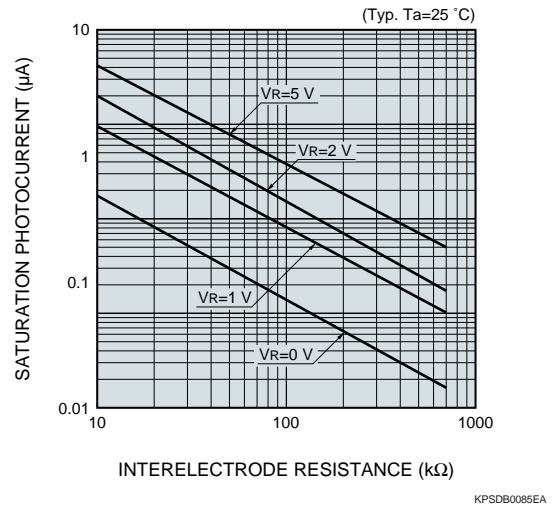

Figure 7-3 Saturation photocurrent vs. interelectrode resistance (entire active area fully illuminated)



Notice

- The information contained in this catalog does not represent or create any warranty, express or implied, including any warranty of merchantability or fitness for any particular purpose.
The terms and conditions of sale contain complete warranty information and is available upon request from your local HAMAMATSU representative.
- The products described in this catalog should be used by persons who are accustomed to the properties of photoelectronics devices, and have expertise in handling and operating them.
They should not be used by persons who are not experienced or trained in the necessary precautions surrounding their use.
- The information in this catalog is subject to change without prior notice.
- Information furnished by HAMAMATSU is believed to be reliable. However, no responsibility is assumed for possible inaccuracies or omission.
- No patent rights are granted to any of the circuits described herein.

HAMAMATSU

HAMAMATSU PHOTONICS K.K., Solid State Division

1126-1, Ichino-cho, Hamamatsu City, 435-8558, Japan

Telephone: (81)53-434-3311, Fax: (81)53-434-5184

Homepage: <http://www.hamamatsu.com>

Main Products

Si photodiodes
Photo IC
PSD
InGaAs PIN photodiodes
Compound semiconductor photosensors
Image sensors
Light emitting diodes
Application products and modules
Optical communication devices
High energy particle/X-ray detectors

Hamamatsu also supplies:

Photoelectric Tubes
Imaging Tubes
Specially Lamps
Imaging and Processing
Systems



Hamamatsu Photonics K. K., Solid State Division is certified by Lloyd's Register Quality Assurance.

Information in this catalog is believed to be reliable. However, no responsibility is assumed for possible inaccuracies or omission. Specifications are subject to change without notice. No patent rights are granted to any of the circuits described herein.

© 2002 Hamamatsu Photonics K.K.

Sales Offices

ASIA:
HAMAMATSU PHOTONICS K.K.
325-6, Sunayama-cho,
Hamamatsu City, 430-8587, Japan
Telephone: (81)53-452-2141, Fax: (81)53-456-7889

U.S.A.:
HAMAMATSU CORPORATION
Main Office
360 Foothill Road, P.O. BOX 6910,
Bridgewater, N.J. 08807-0910, U.S.A.
Telephone: (1)908-231-0960, Fax: (1)908-231-1218
E-mail: usa@hamamatsu.com

Western U.S.A. Office:
Suite 110, 2875 Moorpark Avenue
San Jose, CA 95128, U.S.A.
Telephone: (1)408-261-2022, Fax: (1)408-261-2522
E-mail: usa@hamamatsu.com

United Kingdom:
Hamamatsu Photonics UK Limited
2 Howard Court, 10 Tewin Road, Welwyn Garden City,
Hertfordshire AL7 1BW, United Kingdom
Telephone: (44)1707-294888, Fax: (44)1707-325777
E-mail: info@hamamatsu.co.uk

France, Portugal, Belgium, Switzerland, Spain:
HAMAMATSU PHOTONICS FRANCE S.A.R.L.
8, Rue du Saule Trapu, Parc du Moulin de Massy,
91882 Massy Cedex, France
Telephone: (33)1 69 53 71 00
Fax: (33)1 69 53 71 10
E-mail: infos@hamamatsu.fr

Swiss Office:
Richtersmattweg 6a
CH-3054 Schüpfen, Switzerland
Telephone: (41)31/879 70 70,
Fax: (41)31/879 18 74
E-mail: swiss@hamamatsu.ch

Belgian Office:
7, Rue du Bosquet
B-1348 Louvain-La-Neuve, Belgium
Telephone: (32)10 45 63 34
Fax: (32)10 45 63 67
E-mail: epirson@hamamatsu.com

Spanish Office:
Centro de Empresas de Nuevas Tecnologías
Parque Tecnológico del Valles
08290 CERDANYOLA, (Barcelona) Spain
Telephone: (34)93 582 44 30
Fax: (34)93 582 44 31
E-mail: spain@hamamatsu.com

Germany, Denmark, Netherland, Poland:
HAMAMATSU PHOTONICS DEUTSCHLAND GmbH
Arzbergerstr. 10,
D-82211 Herrsching am Ammersee, Germany
Telephone: (49)8152-375-0, Fax: (49)8152-2658
E-mail: info@hamamatsu.de

Danish Office:
Erantisvej 5
DK-8381 Tilst, Denmark
Telephone: (45)4346/6333, Fax: (45)4346/6350
E-mail: lkoldbaek@hamamatsu.de

Netherlands Office:
PO BOX 50.075, 1305 AB ALMERE, The Netherlands
Telephone: (31)36-5382123, Fax: (31)36-5382124
E-mail: hamamatsu_NL@compuserve.com

Poland Office:
ul. Chodkiewicza 8
PL-02525 Warsaw, Poland
Telephone: (48)22-660-8340, Fax: (48)22-660-8352
E-mail: info@hamamatsu.de

North Europe:
HAMAMATSU PHOTONICS NORDEN AB
Smidesvägen 12
SE-171 41 Solna, Sweden
Telephone: (46)8-509-031-00, Fax: (46)8-509-031-01
E-mail: info@hamamatsu.se

Italy:
HAMAMATSU PHOTONICS ITALIA S.R.L.
Strada della Moia, 1/E
20020 Arese, (Milano), Italy
Telephone: (39)02-935 81 733
Fax: (39)02-935 81 741
E-mail: info@hamamatsu.it

Rome Office:
Via Fosso del Torrino, 51
00144 Roma, Italy
Telephone: (39)06-52246492, Fax: (39)06-52246493
E-mail: inforoma@hamamatsu.it

Hong Kong:
HAKUTO ENTERPRISES LTD.
Room 404, Block B,
Seaview Estate, Watson Road,
North Point, Hong Kong
Telephone: (852)25125729, Fax: (852)28073155

Taiwan:
HAKUTO Taiwan Ltd.
3F-6, No. 188, Section 5, Nanking East Road
Taipei, Taiwan R.O.C.
Telephone: (886)2-2753-0188
Fax: (886)2-2746-5282

KORYO ELECTRONICS CO., LTD.
9F-7, No.79, Hsin Tai Wu Road
Sec.1, Hsi-Chih, Taipei, Taiwan, R.O.C.
Telephone: (886)2-2698-1143, Fax: (886)2-2698-1147

Republic of Korea:
SANGKI TRADING CO., LTD.
Suite 431, World Vision Bldg.,
24-2, Yoido-Dong, Youngdeungpo-ku,
Seoul, Republic of Korea
Telephone: (82)2-780-8515
Fax: (82)2-784-6062

Singapore:
HAKUTO SINGAPORE PTE LTD.
Block 2, Kaki Bukit Avenue 1, #04-01 to #04-04
Kaki Bukit Industrial Estate, Singapore 417938
Telephone: (65)7458910, Fax: (65)7418201