

SANYO	No. 3246	LA5315M
Variable Divided Voltage Generator for LCD Use		

Overview

The LA5315M is a variable divided voltage regulator IC for multiple drive of LCD matrix.

Features

- Power supply for variable bias LCD drive (1/5 to 1/13 bias available by internal resistances)
- 5 voltage outputs
- Low current dissipation (1.5mA max)
- Miniflat package

Maximum Ratings at Ta = 25°C

				unit
Maximum Supply Voltage	V _{CC} max	GND-V _{CC}	-35 to 0	V
Maximum Output Current	I _{OUT} max	V ₁ , V ₂ , V ₃ , V ₄ , V ₅	15	mA
Allowable Power Dissipation	P _d max		370	mW
Operating Temperature	T _{opr}		-20 to +75	°C
Storage Temperature	T _{stg}		-30 to +125	°C

Operating Conditions at Ta = 25°C

				unit
Recommended Supply Voltage	V _{CC}	GND-V _{CC} : (When V ₁ > -1V, I _{IN} is needed.) Note 1	-30 to -10	V
Recommended Input Voltage	V _{REF}	GND-V _{REF} : V _{REF} ≧ V _{CC} Note 1	-30 to -6	V
Recommended Input Current	I _{IN}	V _{IN} : V ₁ > -1V, current source of I _{IN} : 1V or greater relative to GND	0.2 to 3	mA
Recommended Output Current	I _{OUT1}	V ₁	-0.1 to +5	mA
	I _{OUT2,3}	V ₂ , V ₃	-5 to +5	mA
	I _{OUT4,5}	V ₄ , V ₅	-10 to +0.1	mA

Note 1: Set V_{CC}, V_{REF} so that |V₂|, |V_{CC}-V₅| become 1V or greater.

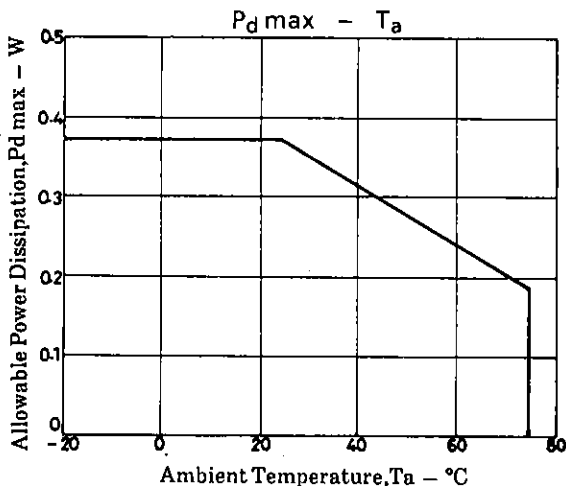

Package Dimensions 3036B
(unit: mm)

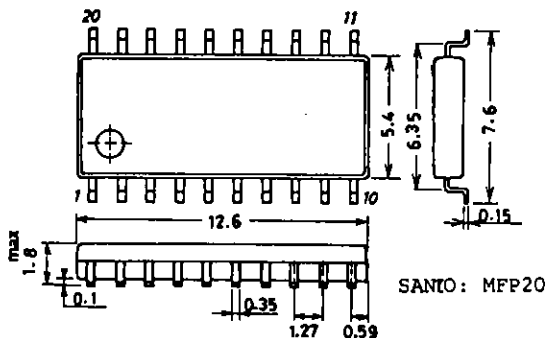

SANTO: MFP20

LA5315M

Operating Characteristics at Ta = 25°C, VCC = -16V				min	typ	max	unit
Current Dissipation		ICC	VIN,GND-VCC, VREF: VCC= VREF = -16V, VIN = GND, RX = 5R			1.5	mA
Output Voltage Ratio	1	Ra1	V2/V1	Vref = -12V VCC = -16V, 1/9 bias (RX = 5R)	1.96	2.00	2.04
	2	Ra2	(V5-V3)/(V5-V4)		1.96	2.00	2.04
	3	Rb1	V5/V1		8.73	9.00	9.27
	4	Rb2	V5/V2		4.37	4.50	4.63
	5	Rb3	V5/(V5-V3)		4.37	4.50	4.63
	6	Rb4	V5/(V5-V4)		8.73	9.00	9.27
Internal Resistance Ratio	1	4R	VIN3-RX1	Resistance ratio referenced to R across pins ⑤ and ⑥			4
	2	5R	VIN3-RX2				5
	3	6R	VIN3-RX3				6
	4	7R	VIN3-RX4				7
	5	8R	VIN3-RX5				8
	6	9R	VIN3-RX6				9
Resistance		R	RX1-RX2: R value when 0.5V is applied across pins ⑤ and ⑥.			20	kΩ
Load Regulation	1	ΔV1	V1: +100μA < IOUT1 < +5mA			20	mV
	2	ΔV2	V2: +100μA < IOUT2 < +5mA			20	mV
	3	ΔV3	V3: +100μA < IOUT3 < +5mA			20	mV
	4	-ΔV2	V2: -5mA < IOUT2 < -100μA			20	mV
	5	-ΔV3	V3: -5mA < IOUT3 < -100μA			20	mV
	6	-ΔV4	V4: -10mA < IOUT4 < -100μA			20	mV
	7	-ΔV5	V5: -10mA < IOUT5 < -100μA			20	mV

Pin Description

Pin No.	Pin Name	Description	Remarks
1	RX6	RX pin	Pin ⑥ shorted RX = 9R
2	RX5	RX pin	Pin ⑥ shorted RX = 8R
3	RX4	RX pin	Pin ⑥ shorted RX = 7R
4	RX3	RX pin	Pin ⑥ shorted RX = 6R
5	RX2	RX pin	Pin ⑥ shorted RX = 5R
6	RX1	RX pin	Pin ⑥ shorted RX = 4R
7		NC	
8		NC	
9	VIN3	V3 input	
10	VIN2	V2 input	
11	VIN	V1 supply (+ supply)	When V1 > -1.0V, VIN is applied. When V1 < -1.0V, this pin is shorted to GND.
12	GND	GND	
13	V1	V1 output	
14	V2	V2 output	
15	V3	V3 output	
16	V4	V4 output	
17	V5	V5 output	
18	VCC	VCC supply (- supply)	
19	VIN5	V5 input	
20	VREF	VREF supply (- supply)	

Note) Do not use the NC pin.

LA5315M

Pin Assignment

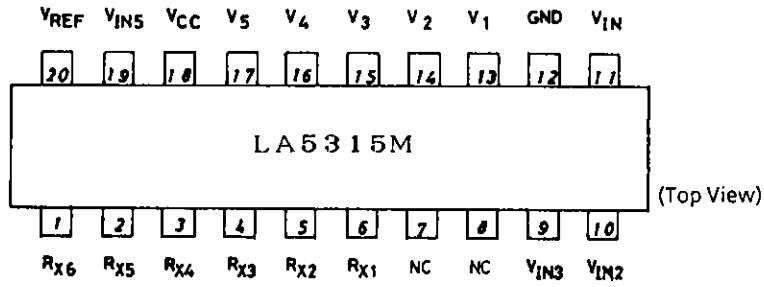

Equivalent Circuit Block Diagram

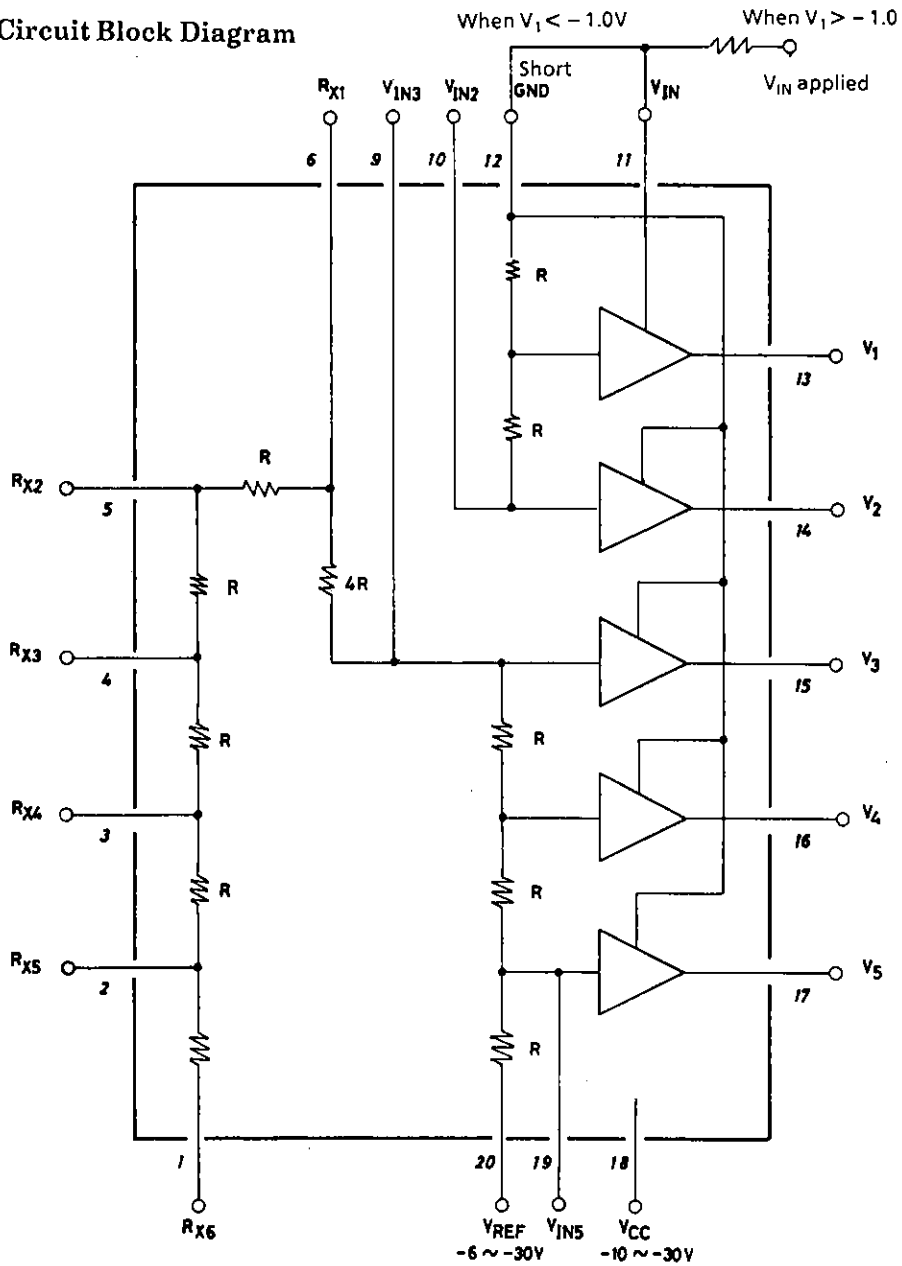

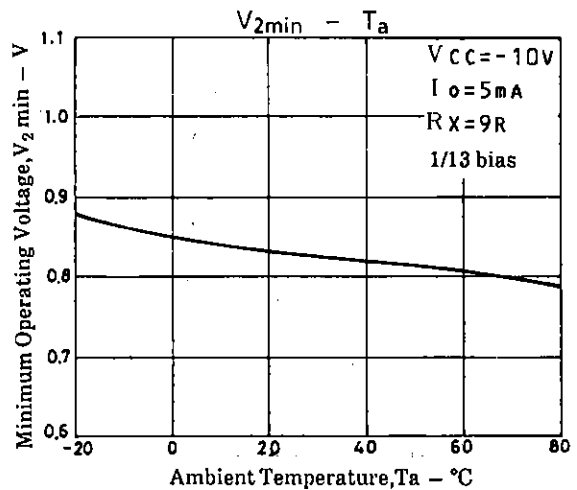
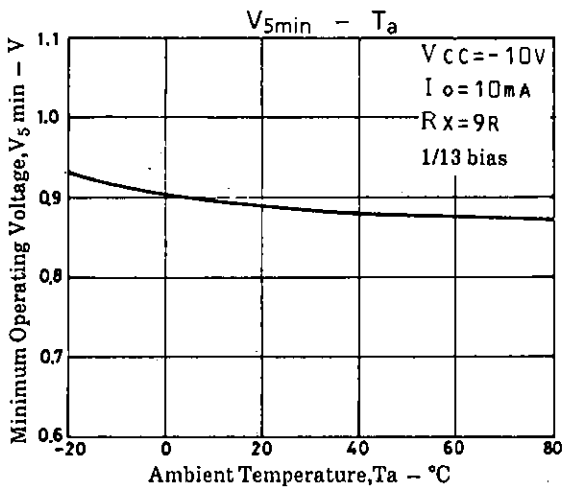
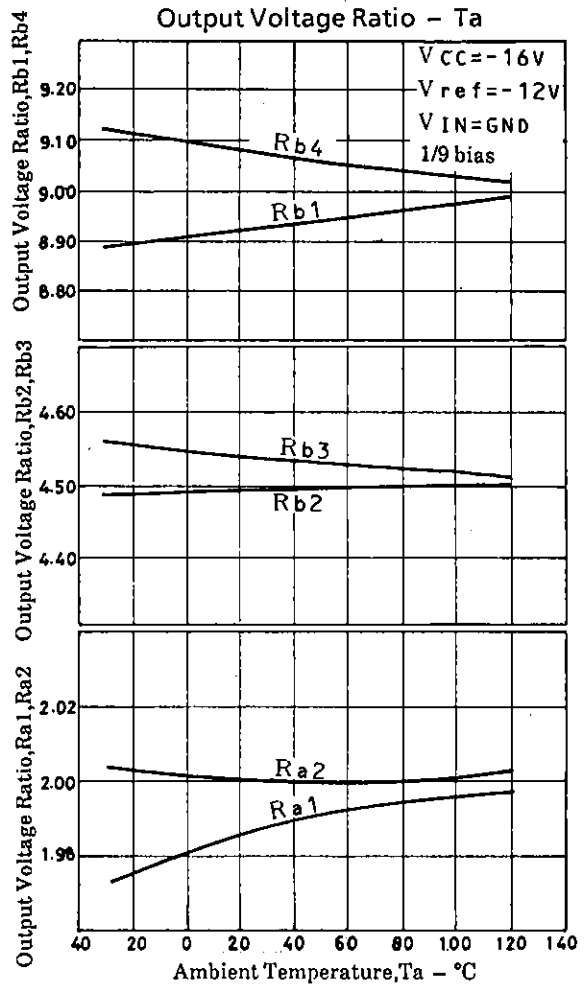
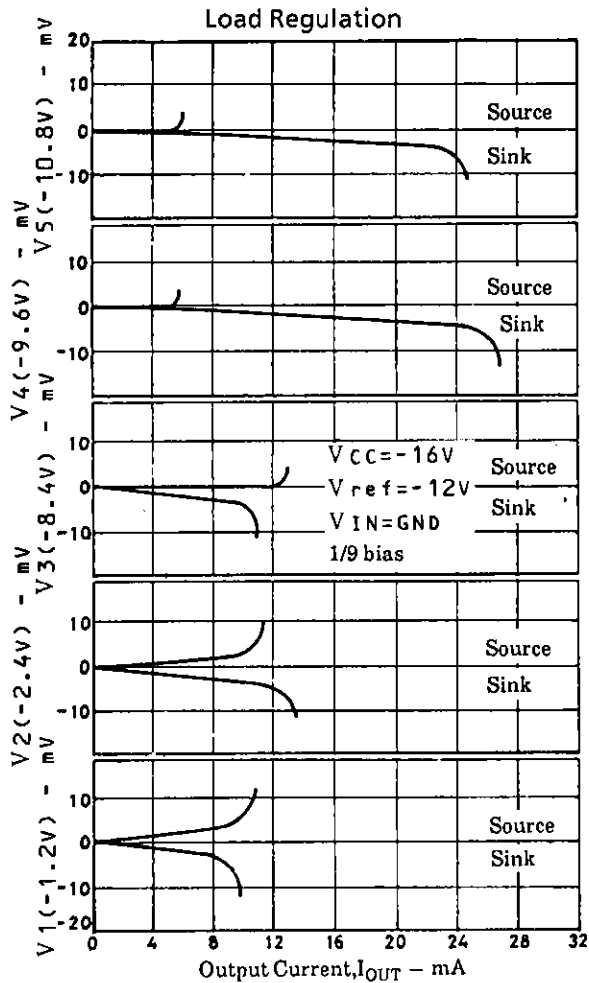

- No products described or contained herein are intended for use in surgical implants, life-support systems, aerospace equipment, nuclear power control systems, vehicles, disaster/crime-prevention equipment and the like, the failure of which may directly or indirectly cause injury, death or property loss.
- Anyone purchasing any products described or contained herein for an above-mentioned use shall:
 - ① Accept full responsibility and indemnify and defend SANYO ELECTRIC CO., LTD., its affiliates, subsidiaries and distributors and all their officers and employees, jointly and severally, against any and all claims and litigation and all damages, cost and expenses associated with such use;
 - ② Not impose any responsibility for any fault or negligence which may be cited in any such claim or litigation on SANYO ELECTRIC CO., LTD., its affiliates, subsidiaries and distributors or any of their officers and employees jointly or severally.
- Information (including circuit diagrams and circuit parameters) herein is for example only; it is not guaranteed for volume production. SANYO believes information herein is accurate and reliable, but no guarantees are made or implied regarding its use or any infringements of intellectual property rights or other rights of third parties.