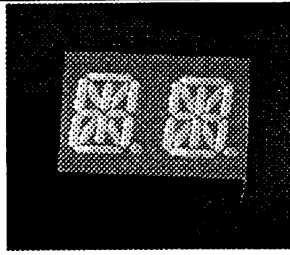
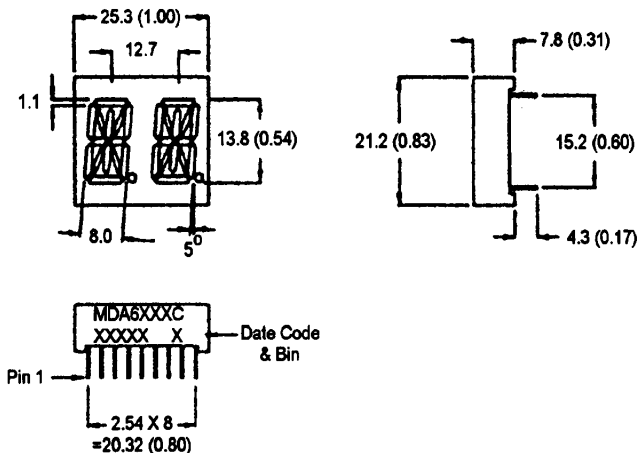

FAIRCHILD

SEMICONDUCTOR™

**0.54 INCH (13.7MM)
14 SEGMENT, DUAL DIGIT
ALPHA - NUMERIC STICK DISPLAY****BRIGHT RED MDA6110C, MDA6140C
YELLOW MDA6310C, MDA6340C
GREEN MDA6410C, MDA6440C
HIGH EFF. RED MDA6910C, MDA6940C****PACKAGE DIMENSIONS**

NOTES: Dimensions are in mm (inch).
All pins are 0.5 (0.02) diameter
Tolerances are ± 0.25 (0.1) unless otherwise noted.

FEATURES

Easy to read digits.
2 digit common anode or cathode.
Low power consumption.
Bold segments that are highly visible.
High brightness with high contrast
White segments on a grey face.
Directly compatible with integrated circuits.
Rugged plastic/epoxy construction.

APPLICATIONS

Digital readout displays.
Instrument panels.

MODEL NUMBERS

<u>Part number</u>	<u>Color</u>	<u>Description</u>
MDA6110C	Bright Red	2 Digit; Common Anode; Rt. Hand Decimal
MDA6140C	Bright Red	2 Digit; Common Cathode; Rt. Hand Decimal
MDA6310C	Yellow	2 Digit; Common Anode; Rt. Hand Decimal
MDA6340C	Yellow	2 Digit; Common Cathode; Rt. Hand Decimal
MDA6410C	Green	2 Digit; Common Anode; Rt. Hand Decimal
MDA6440C	Green	2 Digit; Common Cathode; Rt. Hand Decimal
MDA6910C	High Eff. Red	2 Digit; Common Anode; Rt. Hand Decimal
MDA6940C	High Eff. Red	2 Digit; Common Cathode; Rt. Hand Decimal

(For other colour options, contact your local area Sales Office)

ABSOLUTE MAXIMUM RATING (T_A=25°C unless otherwise specified)

Part number	B.Red MDA 6110C 6140C	Yellow MDA 6310C 6340C	Green MDA 6410C 6440C	High Eff. Red MDA 6910C 6940C	Unit
Continuous forward current (I _f) Per Segment.....	15	20	30	30	mA
Peak forward current per die (I _p). (at f = 1.0 KHz, Duty factor = 1/10)	50	80	90	160	mA
Power dissipation (P _D).....	40*	70*	70*	90*	mW
*Derate Linearly From 25°C.....	0.17	0.25	0.33	0.33	mW/°C
Reverse voltage per dice.....					5V
Operating and Storage temperature range.....					- 40°C to +85°C
Lead soldering time (at 1/16 inch from the bottom of lamp).....					5 seconds @ 230°C

ELECTRO - OPTICAL CHARACTERISTICS (T_A = 25°C unless otherwise specified)

Part number	B. Red MDA 6110C 6140C	Yellow MDA 6310C 6340C	Green MDA 6410C 6440C	High Eff. Red MDA 6910C 6940C	Test Condition
Luminous intensity (ucd) minimum	500	1000	750	1000	I _f = 20 mA
typical	1400	4000	5000	4000	
Forward voltage (V _f) typical	2.1	2.1	2.1	2.0	I _f = 20 mA
maximum	2.6	2.8	2.8	2.8	
Peak wavelength (nm)	697	590	570	635	I _f = 20 mA
Spectral line half width (nm)	90	35	30	45	I _f = 20 mA
Reverse breakdown voltage (V _R)	5	5	5	5	I _r = 100 uA

PINOUT

MDA6X10C - Common Anode; Pin 3 - no connection

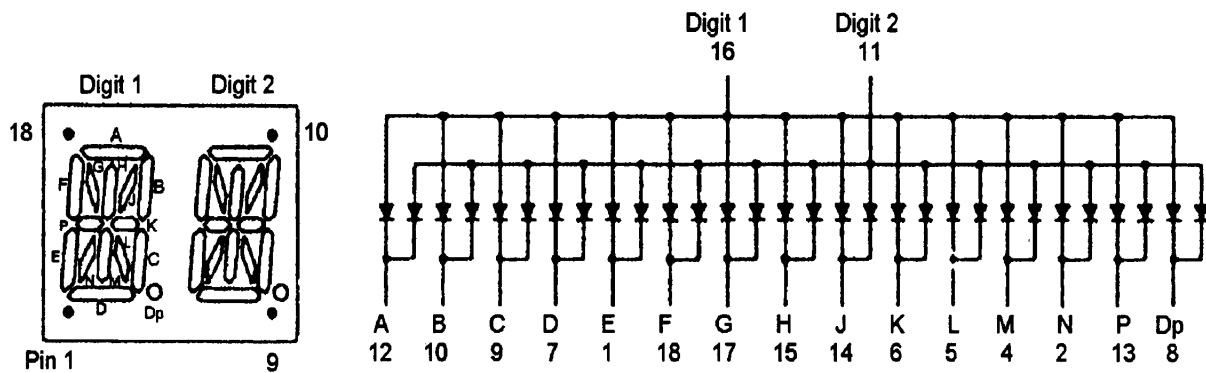

MDA6X40C - Common Cathode; Pin 3 - no connection

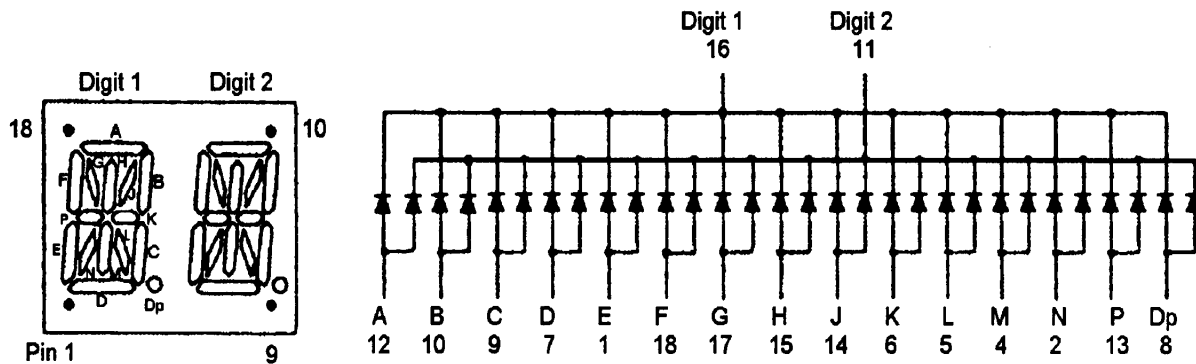

GRAPHICAL DETAIL: Bright Red ($T_A = 25^\circ\text{C}$ unless otherwise specified)

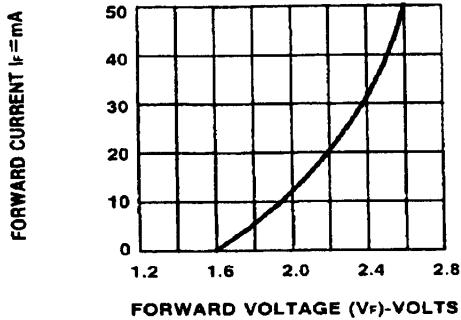

Fig.1 FORWARD CURRENT VS. FORWARD VOLTAGE.

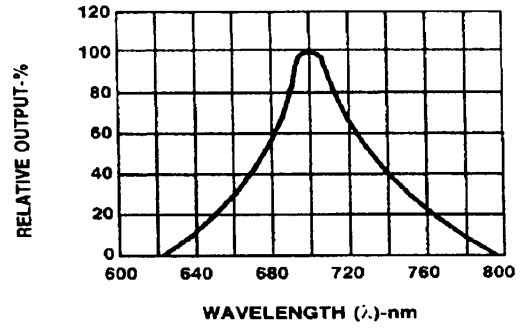

Fig.2 SPECTRAL RESPONSE

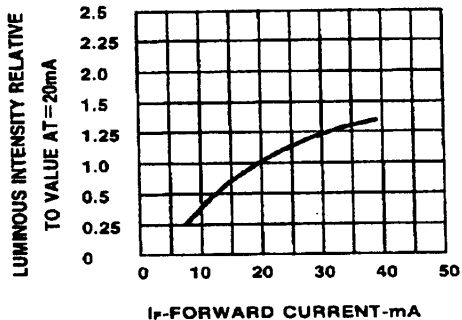

Fig.3 RELATIVE LUMINOUS INTENSITY VS. FORWARD CURRENT

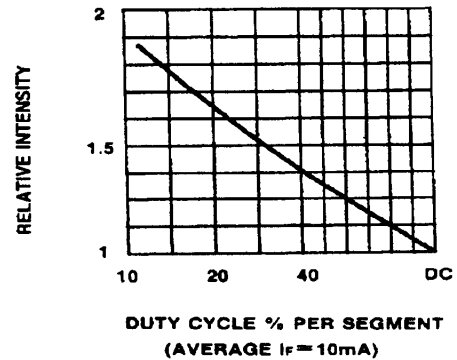

Fig.5 LUMINOUS INTENSITY VS. DUTY CYCLE

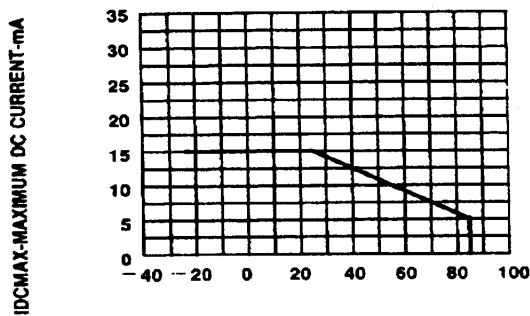

Fig.4 MAXIMUM ALLOWABLE DC CURRENT PER SEGMENT VS. A FUNCTION OF AMBIENT TEMPERATURE.

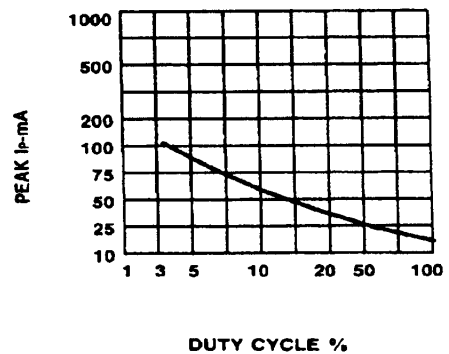

Fig. 6 MAX PEAK CURRENT VS. DUTY CYCLE % (REFRESH RATE $f = 1 \text{ KHz}$)

GRAPHICAL DETAIL: Green ($T_A = 25^\circ\text{C}$ unless otherwise specified)

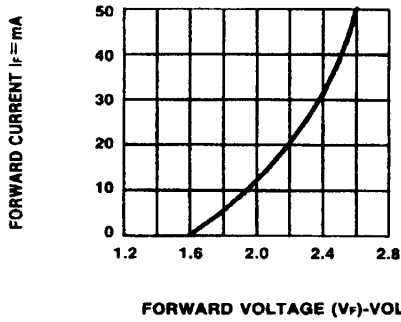

Fig.1 FORWARD CURRENT VS. FORWARD VOLTAGE.

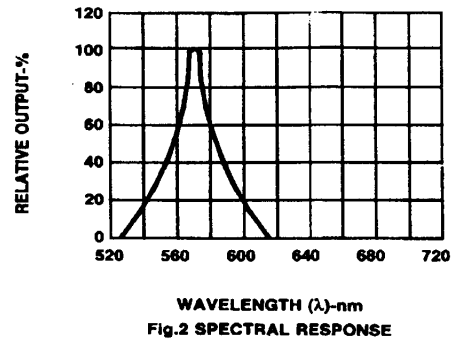

Fig.2 SPECTRAL RESPONSE

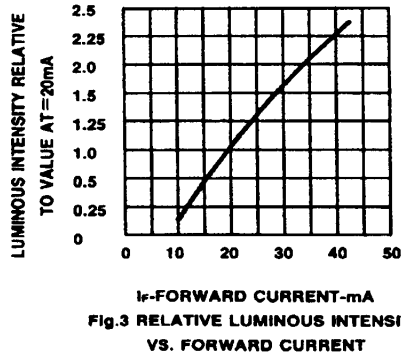

Fig.3 RELATIVE LUMINOUS INTENSITY VS. FORWARD CURRENT

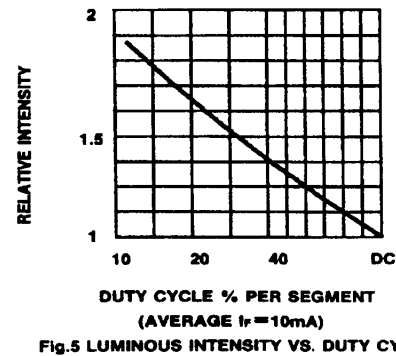

Fig.5 LUMINOUS INTENSITY VS. DUTY CYCLE

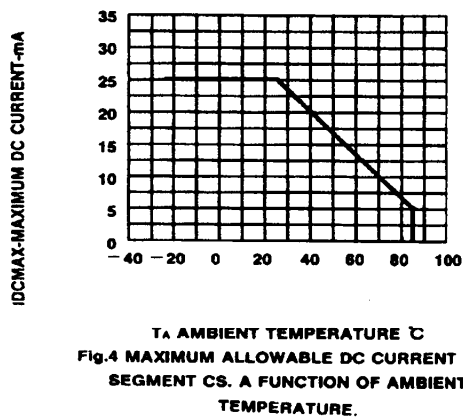

Fig.4 MAXIMUM ALLOWABLE DC CURRENT PER SEGMENT CS. A FUNCTION OF AMBIENT TEMPERATURE.

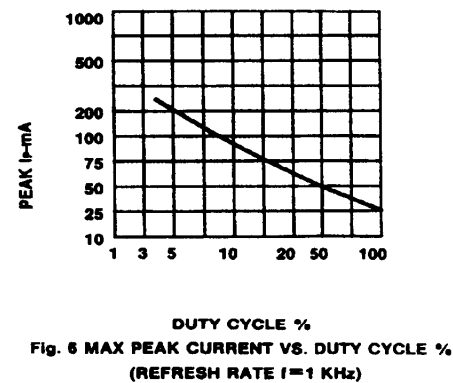

Fig. 6 MAX PEAK CURRENT VS. DUTY CYCLE % (REFRESH RATE $f = 1\text{ KHz}$)

GRAPHICAL DETAIL: High Efficiency Red ($T_A = 25^\circ\text{C}$ unless otherwise specified)

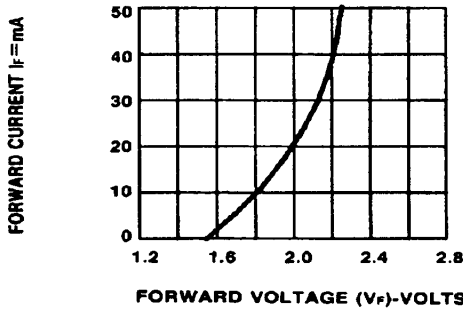

Fig.1 FORWARD CURRENT VS. FORWARD VOLTAGE.

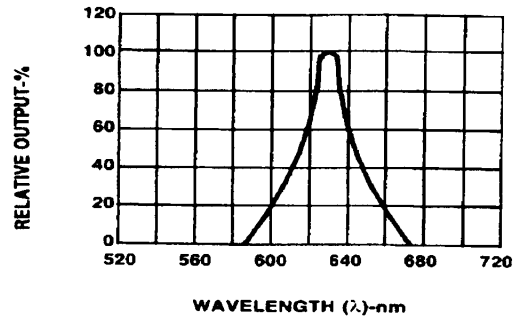

Fig.2 SPECTRAL RESPONSE

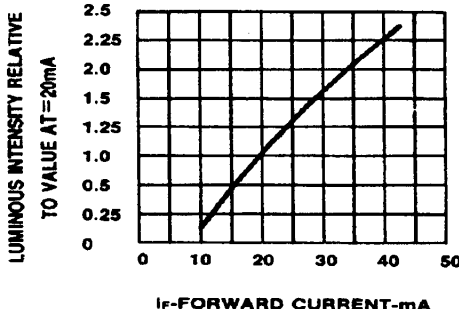

Fig.3 RELATIVE LUMINOUS INTENSITY VS. FORWARD CURRENT

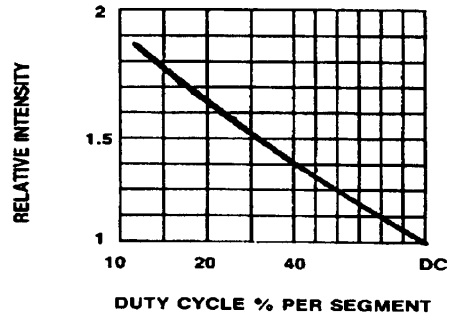

Fig.5 LUMINOUS INTENSITY VS. DUTY CYCLE (AVERAGE $I_f = 10\text{mA}$)

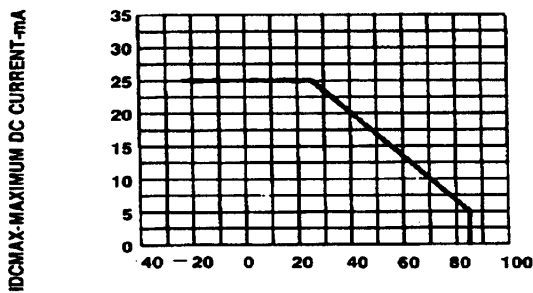

Fig.4 MAXIMUM ALLOWABLE DC CURRENT PER SEGMENT VS. A FUNCTION OF AMBIENT TEMPERATURE.

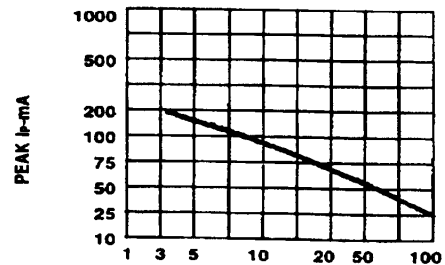

Fig. 6 MAX PEAK CURRENT VS. DUTY CYCLE % (REFRESH RATE $f = 1\text{ KHz}$)

GRAPHICAL DETAIL: Yellow ($T_A = 25^\circ\text{C}$ unless otherwise specified)

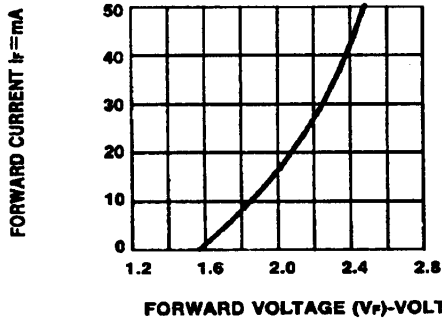

Fig.1 FORWARD CURRENT VS. FORWARD VOLTAGE.

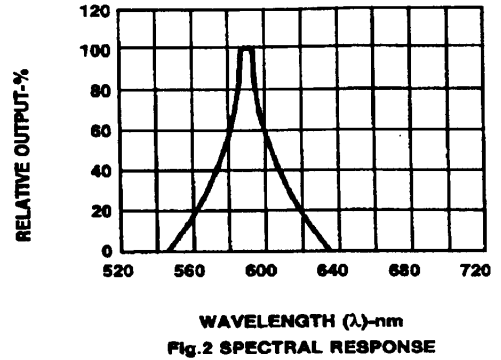

Fig.2 SPECTRAL RESPONSE

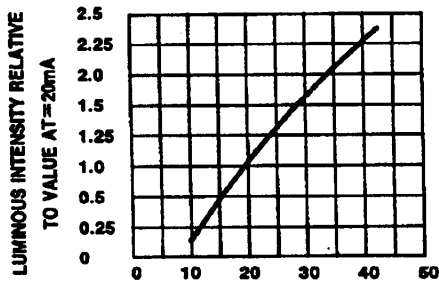

Fig.3 RELATIVE LUMINOUS INTENSITY VS. FORWARD CURRENT

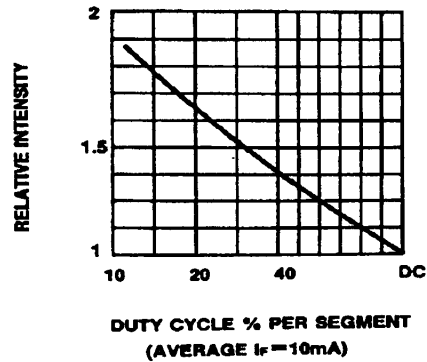

Fig.5 LUMINOUS INTENSITY VS. DUTY CYCLE

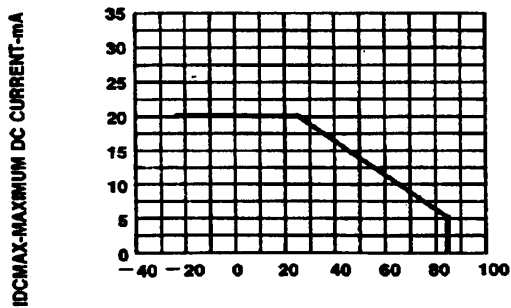

Fig.4 MAXIMUM ALLOWABLE DC CURRENT PER SEGMENT VS. A FUNCTION OF AMBIENT TEMPERATURE.

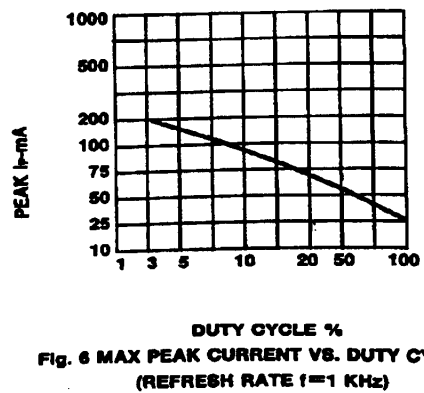

Fig. 6 MAX PEAK CURRENT VS. DUTY CYCLE % (REFRESH RATE $f = 1\text{ KHz}$)

DISCLAIMER

FAIRCHILD SEMICONDUCTOR RESERVES THE RIGHT TO MAKE CHANGES WITHOUT FURTHER NOTICE TO ANY PRODUCTS HEREIN TO IMPROVE RELIABILITY, FUNCTION OR DESIGN. FAIRCHILD DOES NOT ASSUME ANY LIABILITY ARISING OUT OF THE APPLICATION OR USE OF ANY PRODUCT OR CIRCUIT DESCRIBED HEREIN; NEITHER DOES IT CONVEY ANY LICENSE UNDER ITS PATENT RIGHTS, NOR THE RIGHTS OF OTHERS.

LIFE SUPPORT POLICY

FAIRCHILD'S PRODUCTS ARE NOT AUTHORIZED FOR USE AS CRITICAL COMPONENTS IN LIFE SUPPORT DEVICES OR SYSTEMS WITHOUT THE EXPRESS WRITTEN APPROVAL OF THE PRESIDENT OF FAIRCHILD SEMICONDUCTOR CORPORATION. As used herein:

1. Life support devices or systems are devices or systems which, (a) are intended for surgical implant into the body, or (b) support or sustain life, and (c) whose failure to perform when properly used in accordance with instructions for use provided in the labeling, can be reasonably expected to result in a significant injury of the user.
2. A critical component in any component of a life support device or system whose failure to perform can be reasonably expected to cause the failure of the life support device or system, or to affect its safety or effectiveness.