

HMC398QS16G

Ku-Band MMIC VCO with DIVIDE-BY-8, 14.0 - 15.0 GHz

Typical Applications

Low noise MMIC VCO w/Divide-by-8 for Ku-Band applications such as:

- Pt to Pt Radios
- Multi-Pt Radios / LMDS
- VSAT

Functional Diagram

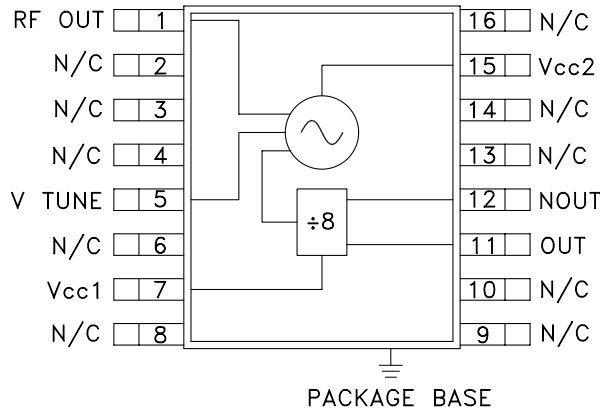

Features

- Pout: +7 dBm
- Phase Noise: -105 dBc/Hz @ 100 KHz Typ.
- No External Resonator Needed
- Single Supply: 5V @ 325 mA
- QSOP16G SMT Package

General Description

The HMC398QS16G is a single chip GaAs InGaP Heterojunction Bipolar Transistor (HBT) MMIC VCO. The HMC398QS16G integrates a resonator, negative resistance device, varactor diode and divide-by-8 prescaler. The VCO's phase noise performance is excellent over temperature, shock, and process due to the oscillator's monolithic structure. Power output is +7 dBm typical from a 5V supply voltage. The voltage controlled oscillator is packaged in a low cost, surface mount 16 lead QSOP package with an exposed base for improved RF and thermal performance. The HMC398QS16G requires no external components

Electrical Specifications, $T_A = +25^\circ C$, $V_{cc1}, V_{cc2} = +5.0V$

Parameter	Min.	Typ.	Max.	Units
Frequency Range	14.0 - 15.0			GHz
Power Output	RF Output Divided Output	+3 -9	+7 -6	dBm dBm
SSB Phase Noise @ 100 kHz Offset, $V_{tune} = +5V$ @ RF Output		-105		dBc/Hz
Tune Voltage	V_{tune}	1.0	10.0	V
Supply Current	I_{cc1} (Digital) I_{cc2} (RF)		65 260	mA mA
Tune Port Leakage Current ($V_{tune} = 10V$)			10	μA
Output Return Loss		2		dB
Harmonics/Subharmonics	1/2 3/2 2nd 5/2		-20 -30 -12 -40	dBc dBc dBc dBc
Pulling (into a 2.0:1 VSWR)		4		MHz pp
Pushing @ $V_{tune} = 5V$		30		MHz/V
Frequency Drift Rate		1.5		MHz/ $^\circ C$

HMC398QS16G

Ku-Band MMIC VCO with DIVIDE-BY-8, 14.0 - 15.0 GHz

Frequency vs. Tuning Voltage, T= 25°C

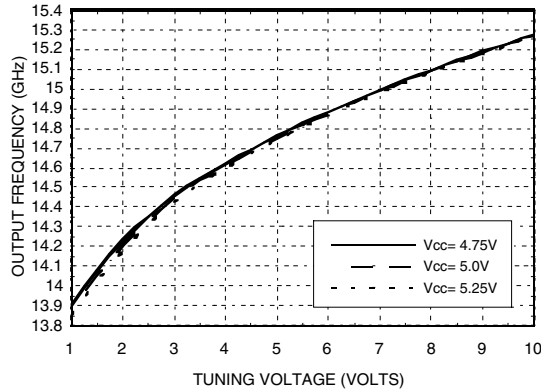

Frequency vs. Tuning Voltage, Vcc= +5V

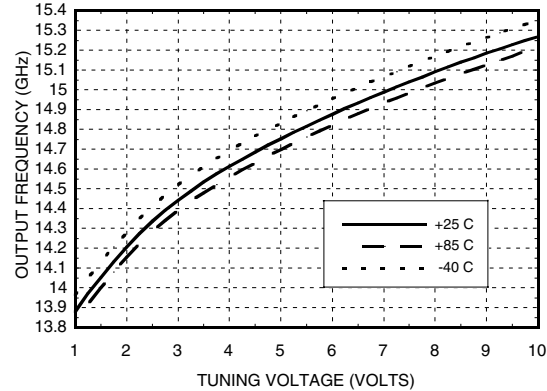

Sensitivity vs. Tuning Voltage, Vcc= +5V

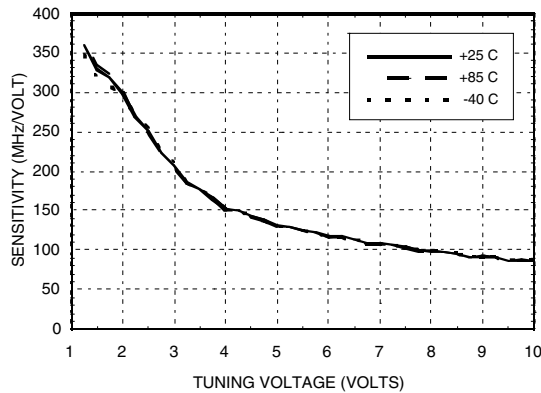

Output Power vs. Tuning Voltage, Vcc= +5V

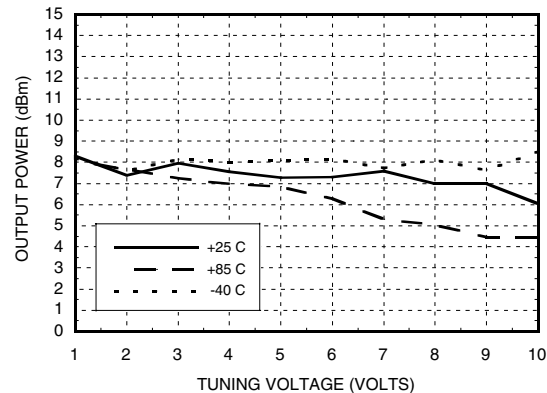

SSB Phase Noise vs. Tuning Voltage

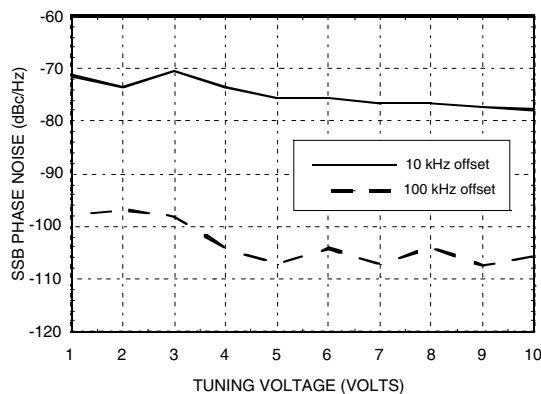

SSB Phase Noise @ Vtune= 5V

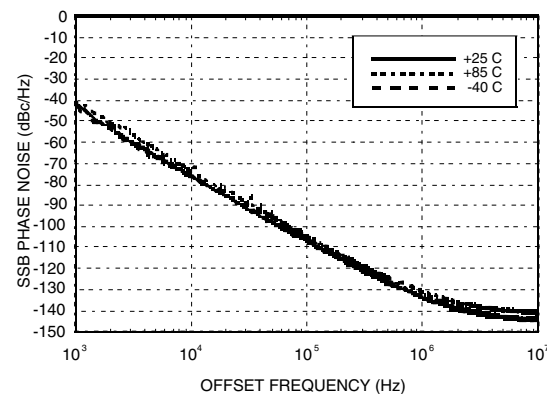

Ku-Band MMIC VCO with DIVIDE-BY-8, 14.0 - 15.0 GHz

**Divided Output
Frequency vs. Tuning Voltage, Vcc= +5V**

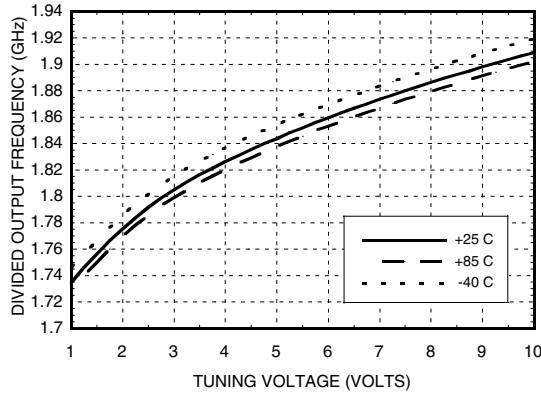

**Divided Output
Power vs. Tuning Voltage, Vcc= +5V***

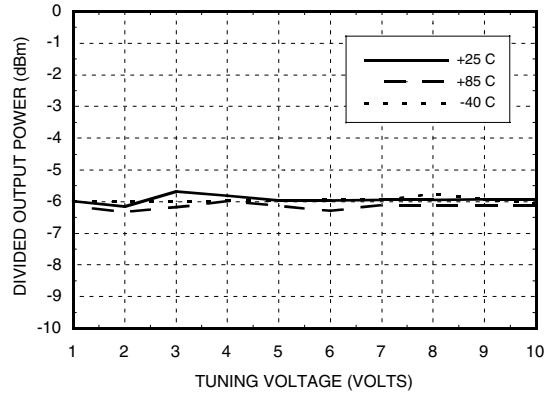

**Divided Output
SSB Phase Noise @ Vtune = 5V**

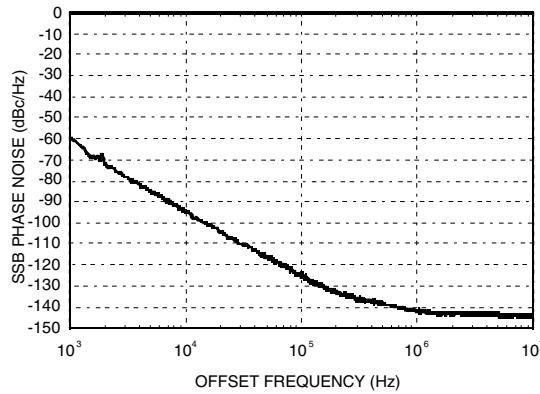

*Note: Tuning voltage must not drop below 1.0V for proper divider output.

Ku-Band MMIC VCO with DIVIDE-BY-8, 14.0 - 15.0 GHz

Absolute Maximum Ratings

Vcc1, Vcc2	+5.5
Storage Temperature	-65 to +150 °C
Operating Temperature	-40 to +85 °C
Vtune	0 to 11V

Typical Supply Current vs. Vcc

Vcc (V)	Icc (mA)
4.75	300
5.0	325
5.25	350

Note: VCO will operate over full voltage range shown above.

Outline Drawing

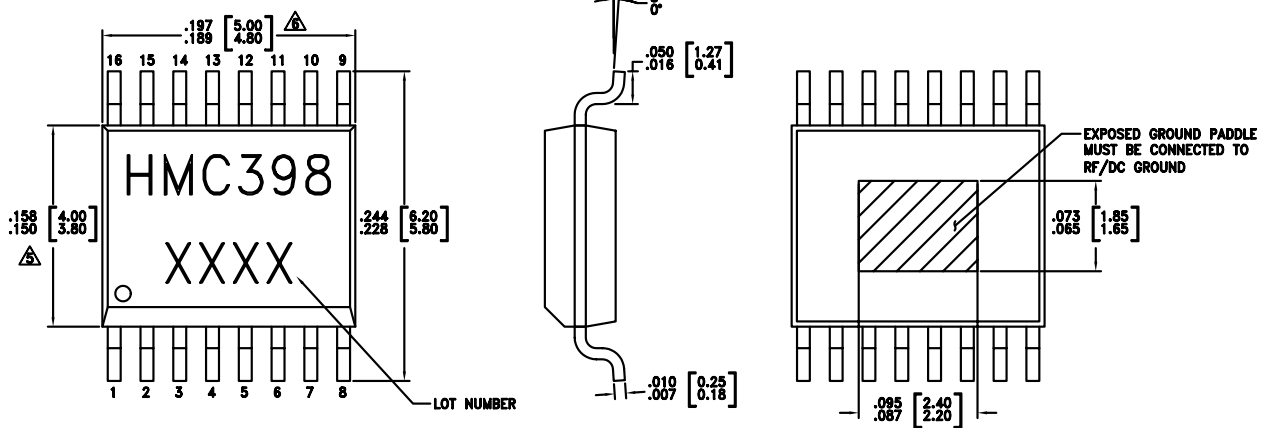



NOTES:

1. PACKAGE BODY MATERIAL: LOW STRESS INJECTION MOLDED PLASTIC. SILICA AND SILICON IMPREGNATED.
2. LEADFRAME MATERIAL: COPPER ALLOY
3. LEADFRAME PLATING: TIN/LEAD SOLDER
4. DIMENSIONS ARE IN INCHES [MILLIMETERS].
5. DIMENSION DOES NOT INCLUDE MOLDFLASH OF 0.15 mm PER SIDE.
6. DIMENSION DOES NOT INCLUDE MOLDFLASH OF 0.25 mm PER SIDE.
7. ALL GROUND LEADS AND GROUND PADDLE MUST BE SOLDERED TO PCB RF & DC GROUND.

Ku-Band MMIC VCO with DIVIDE-BY-8, 14.0 - 15.0 GHz

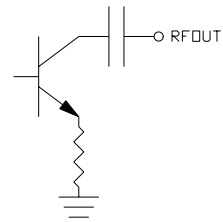
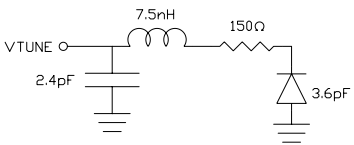
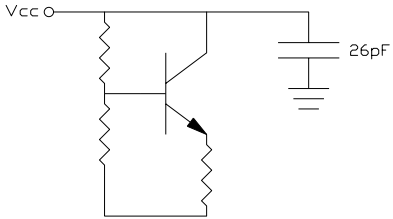
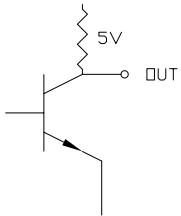
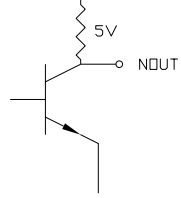
Pin Descriptions

Pin Number	Function	Description	Interface Schematic
1	RF OUT	RF output (AC coupled).	
2, 3, 4, 6, 8, 9, 10, 13, 14, 16	N/C	No Connection	
5	VTUNE	Control Voltage Input. Modulation port bandwidth dependent on drive source impedance.	
7, 15	VCC1, VCC2	Supply Voltage, 5V	
11	OUT	Divided Output	
12	NOUT	Divided Output 180° output phase with pin 11.	
	GND	Package bottom has an exposed metal paddle that must be RF & DC grounded.	

15

VCOS - SMT

Evaluation PCB

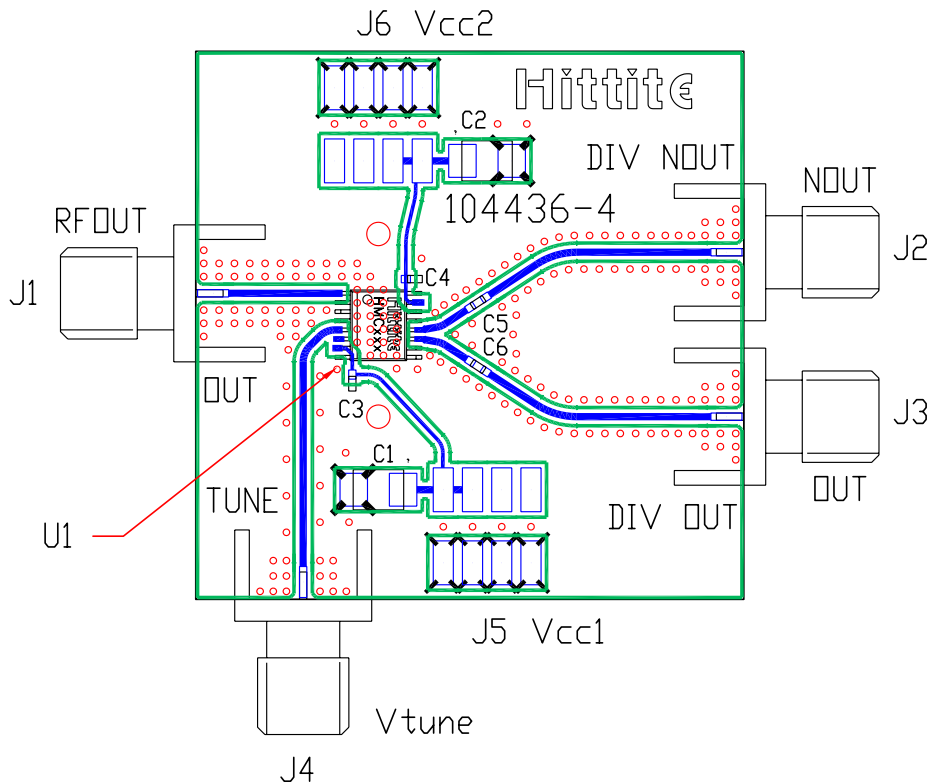

List of Materials

Item	Description
J1 - J4	PC Mount SMA RF Connector
J5 - J6	2 mm DC Header
C1 - C2	10 μ F Tantalum Capacitor
C3 - C6	1,000 pF Capacitor 0402 Pkg.
U1	HMC398QS16G VCO
PCB*	104436 Eval Board

* Circuit Board Material: Rogers 4350

The circuit board used in the final application should use RF circuit design techniques. Signal lines should have 50 ohm impedance while the package ground leads and backside ground slug should be connected directly to the ground plane similar to that shown. A sufficient number of via holes should be used to connect the top and bottom ground planes. The evaluation circuit board shown is available from Hittite upon request.

***Ku-Band MMIC VCO with
DIVIDE-BY-8, 14.0 - 15.0 GHz***

Typical Application Circuit

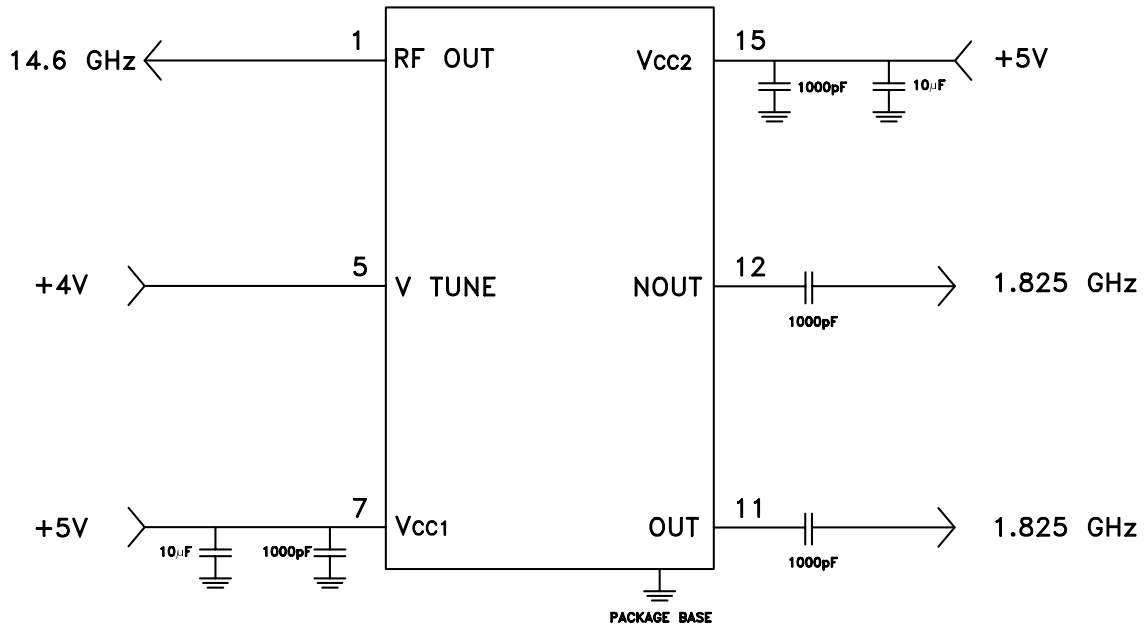

15

VCOs - SMT

*Ku-Band MMIC VCO with
DIVIDE-BY-8, 14.0 - 15.0 GHz*

Notes: