

**Features**

- Advanced Process Technology
- Ultra Low On-Resistance
- Dynamic dv/dt Rating
- 175°C Operating Temperature
- Fast Switching
- Repetitive Avalanche Allowed up to Tjmax

**Description**

Specifically designed for Automotive applications, this HEXFET® Power MOSFET utilizes the latest processing techniques to achieve extremely low on-resistance per silicon area. Additional features of this design are a 175°C junction operating temperature, fast switching speed and improved repetitive avalanche rating. These features combine to make this design an extremely efficient and reliable device for use in Automotive applications and a wide variety of other applications.

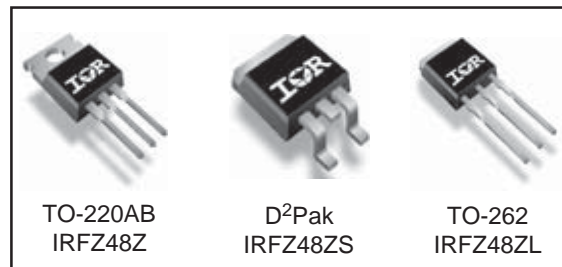
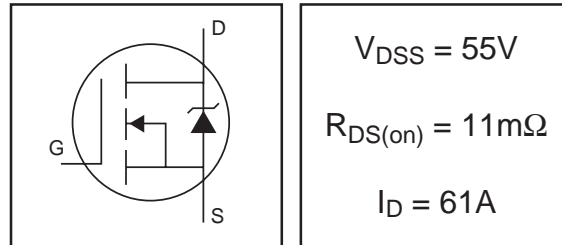

**Absolute Maximum Ratings**

	Parameter	Max.	Units
$I_D @ T_C = 25^\circ C$	Continuous Drain Current, $V_{GS} @ 10V$ (Silicon Limited)	61	A
$I_D @ T_C = 100^\circ C$	Continuous Drain Current, $V_{GS} @ 10V$ (See Fig. 9)	43	
$I_{DM}$	Pulsed Drain Current ①	240	
$P_D @ T_C = 25^\circ C$	Maximum Power Dissipation	91	W
	Linear Derating Factor	0.61	W/°C
$V_{GS}$	Gate-to-Source Voltage	$\pm 20$	V
$E_{AS}$	Single Pulse Avalanche Energy (Thermally Limited) ②	73	mJ
$E_{AS} (tested)$	Single Pulse Avalanche Energy Tested Value ②	120	
$I_{AR}$	Avalanche Current ①	See Fig.12a,12b,15,16	A
$E_{AR}$	Repetitive Avalanche Energy ③		mJ
$T_J$	Operating Junction and	-55 to + 175	°C
$T_{STG}$	Storage Temperature Range		
	Soldering Temperature, for 10 seconds		
	Mounting torque, 6-32 or M3 screw	10 lbf•in (1.1N•m)	

**Thermal Resistance**

	Parameter	Typ.	Max.	Units
$R_{\theta JC}$	Junction-to-Case	—	1.64	°C/W
$R_{\theta CS}$	Case-to-Sink, Flat, Greased Surface	0.50	—	
$R_{\theta JA}$	Junction-to-Ambient	—	62	
$R_{\theta JA}$	Junction-to-Ambient (PCB Mount, steady state)④	—	40	

HEXFET® is a registered trademark of International Rectifier.

# IRFZ48Z/S/L

International  
IR Rectifier

Static @  $T_J = 25^\circ\text{C}$  (unless otherwise specified)

	Parameter	Min.	Typ.	Max.	Units	Conditions
$V_{(BR)DSS}$	Drain-to-Source Breakdown Voltage	55	—	—	V	$V_{GS} = 0V, I_D = 250\mu A$
$\Delta BV_{DSS}/\Delta T_J$	Breakdown Voltage Temp. Coefficient	—	0.054	—	V/ $^\circ\text{C}$	Reference to $25^\circ\text{C}, I_D = 1mA$
$R_{DS(on)}$	Static Drain-to-Source On-Resistance	—	8.6	11	m $\Omega$	$V_{GS} = 10V, I_D = 37A$ ②
$V_{GS(th)}$	Gate Threshold Voltage	2.0	—	4.0	V	$V_{DS} = V_{GS}, I_D = 250\mu A$
$g_{fs}$	Forward Transconductance	24	—	—	S	$V_{DS} = 25V, I_D = 37A$
$I_{DSS}$	Drain-to-Source Leakage Current	—	—	20	$\mu A$	$V_{DS} = 55V, V_{GS} = 0V$
		—	—	250		$V_{DS} = 55V, V_{GS} = 0V, T_J = 125^\circ\text{C}$
$I_{GSS}$	Gate-to-Source Forward Leakage	—	—	200	nA	$V_{GS} = 20V$
	Gate-to-Source Reverse Leakage	—	—	-200		$V_{GS} = -20V$
$Q_g$	Total Gate Charge	—	43	64	nC	$I_D = 37A$
$Q_{gs}$	Gate-to-Source Charge	—	11	16		$V_{DS} = 44V$
$Q_{gd}$	Gate-to-Drain ("Miller") Charge	—	16	24		$V_{GS} = 10V$ ④
$t_{d(on)}$	Turn-On Delay Time	—	15	—	ns	$V_{DD} = 28V$
$t_r$	Rise Time	—	69	—		$I_D = 37A$
$t_{d(off)}$	Turn-Off Delay Time	—	35	—		$R_G = 12\Omega$
$t_f$	Fall Time	—	39	—		$V_{GS} = 10V$ ④
$L_D$	Internal Drain Inductance	—	4.5	—	nH	Between lead, 6mm (0.25in.) from package and center of die contact
$L_S$	Internal Source Inductance	—	7.5	—		
$C_{iss}$	Input Capacitance	—	1720	—	pF	$V_{GS} = 0V$
$C_{oss}$	Output Capacitance	—	300	—		$V_{DS} = 25V$
$C_{riss}$	Reverse Transfer Capacitance	—	160	—		$f = 1.0MHz$ , See Fig. 5
$C_{oss}$	Output Capacitance	—	1020	—		$V_{GS} = 0V, V_{DS} = 1.0V, f = 1.0MHz$
$C_{oss}$	Output Capacitance	—	230	—		$V_{GS} = 0V, V_{DS} = 44V, f = 1.0MHz$
$C_{oss\ eff.}$	Effective Output Capacitance	—	380	—		$V_{GS} = 0V, V_{DS} = 0V$ to 44V

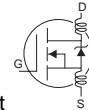

## Diode Characteristics

	Parameter	Min.	Typ.	Max.	Units	Conditions
$I_S$	Continuous Source Current (Body Diode)	—	—	61	A	MOSFET symbol showing the integral reverse p-n junction diode.
$I_{SM}$	Pulsed Source Current (Body Diode) ①	—	—	240		
$V_{SD}$	Diode Forward Voltage	—	—	1.3	V	$T_J = 25^\circ\text{C}, I_S = 37A, V_{GS} = 0V$ ④
$t_{rr}$	Reverse Recovery Time	—	20	31	ns	$T_J = 25^\circ\text{C}, I_F = 37A, V_{DD} = 30V$
$Q_{rr}$	Reverse Recovery Charge	—	13	20	nC	$di/dt = 100A/\mu s$ ④
$t_{on}$	Forward Turn-On Time	Intrinsic turn-on time is negligible (turn-on is dominated by $L_S+L_D$ )				

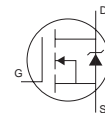

### Notes:

- ① Repetitive rating; pulse width limited by max. junction temperature. (See fig. 11).
- ② Limited by  $T_{Jmax}$ , starting  $T_J = 25^\circ\text{C}$ ,  $L = 0.11mH$ ,  $R_G = 25\Omega$ ,  $I_{AS} = 37A$ ,  $V_{GS} = 10V$ . Part not recommended for use above this value.
- ③  $I_{SD} \leq 37A$ ,  $di/dt \leq 920A/\mu s$ ,  $V_{DD} \leq V_{(BR)DSS}$ ,  $T_J \leq 175^\circ\text{C}$ .
- ④ Pulse width  $\leq 1.0ms$ ; duty cycle  $\leq 2\%$ .

- ⑤  $C_{oss\ eff.}$  is a fixed capacitance that gives the same charging time as  $C_{oss}$  while  $V_{DS}$  is rising from 0 to 80%  $V_{DSS}$ .
- ⑥ Limited by  $T_{Jmax}$ , see Fig.12a, 12b, 15, 16 for typical repetitive avalanche performance.
- ⑦ This value determined from sample failure population. 100% tested to this value in production.
- ⑧ This is applied to D<sup>2</sup>Pak, when mounted on 1" square PCB (FR-4 or G-10 Material). For recommended footprint and soldering techniques refer to application note #AN-994.

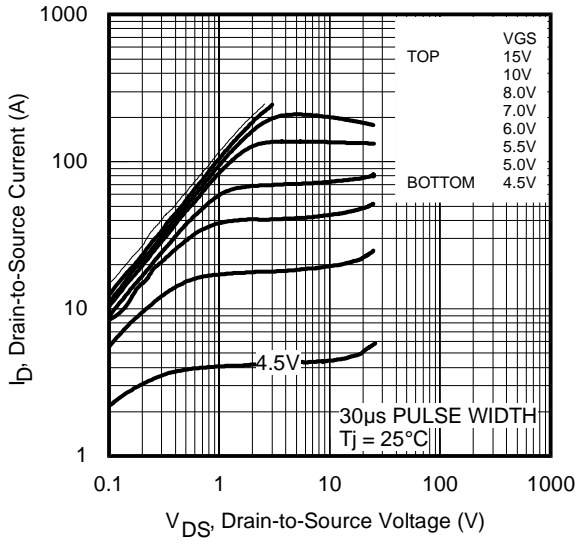

**Fig 1.** Typical Output Characteristics

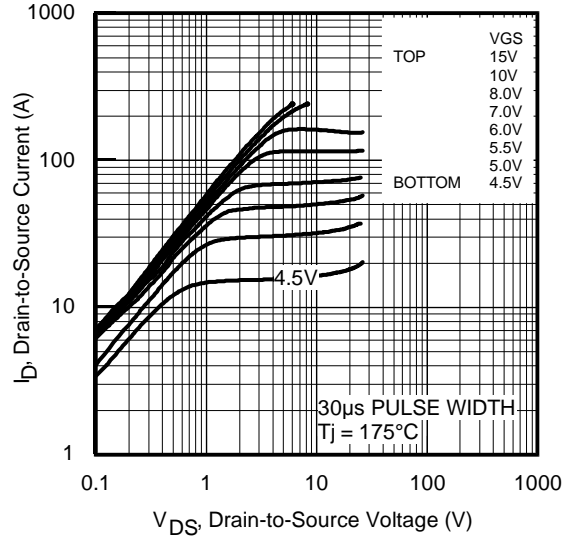

**Fig 2.** Typical Output Characteristics

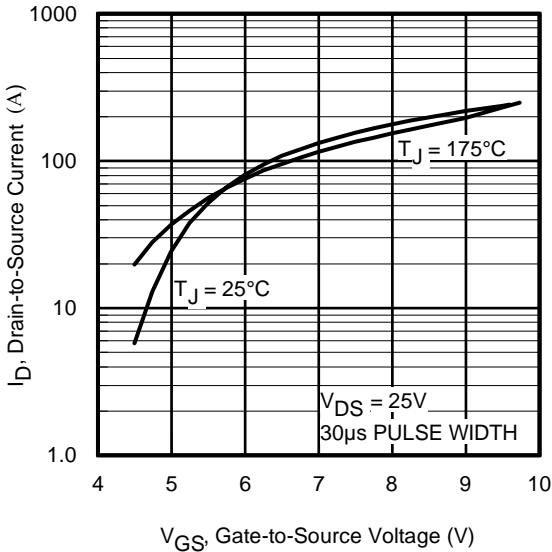

**Fig 3.** Typical Transfer Characteristics

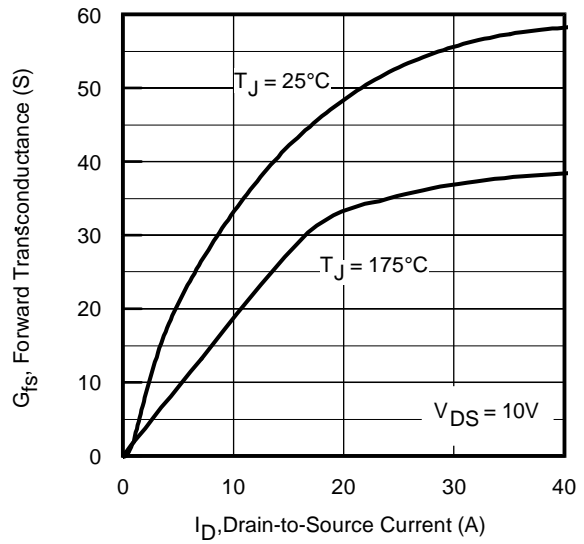

**Fig 4.** Typical Forward Transconductance vs. Drain Current

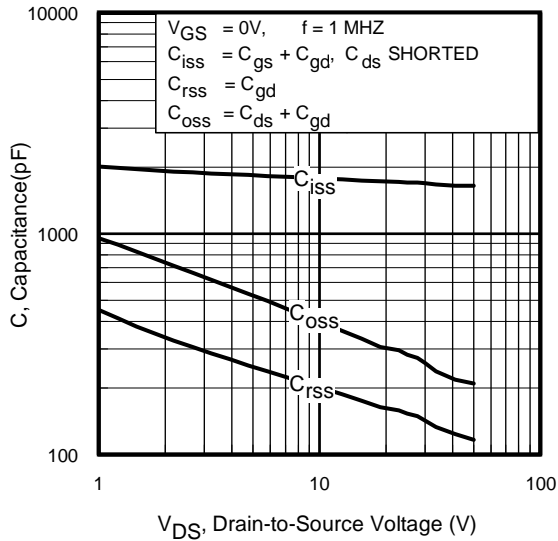

**Fig 5.** Typical Capacitance vs. Drain-to-Source Voltage

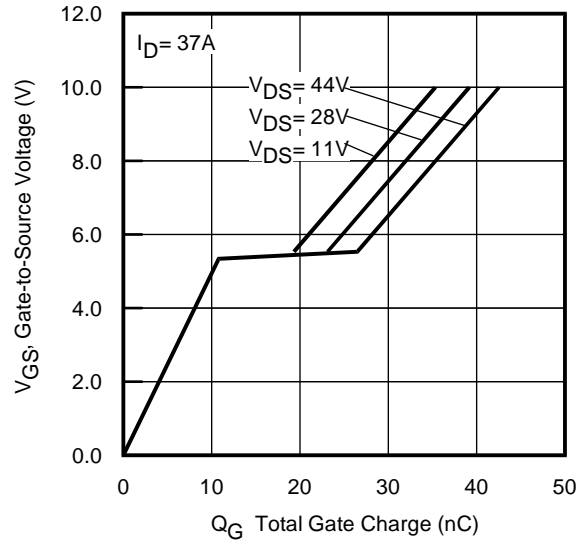

**Fig 6.** Typical Gate Charge vs. Gate-to-Source Voltage

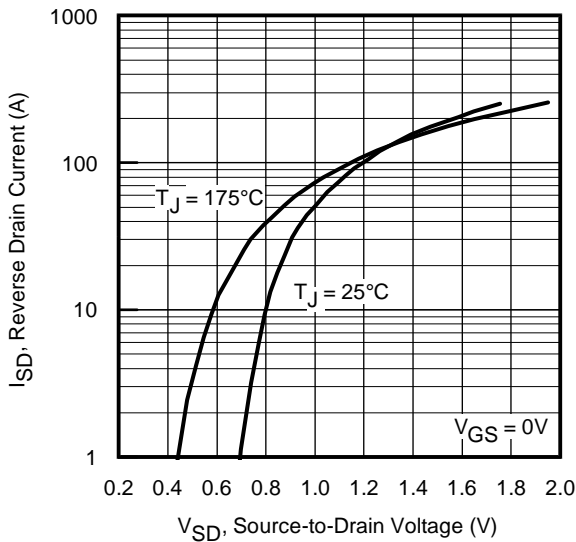

**Fig 7.** Typical Source-Drain Diode Forward Voltage

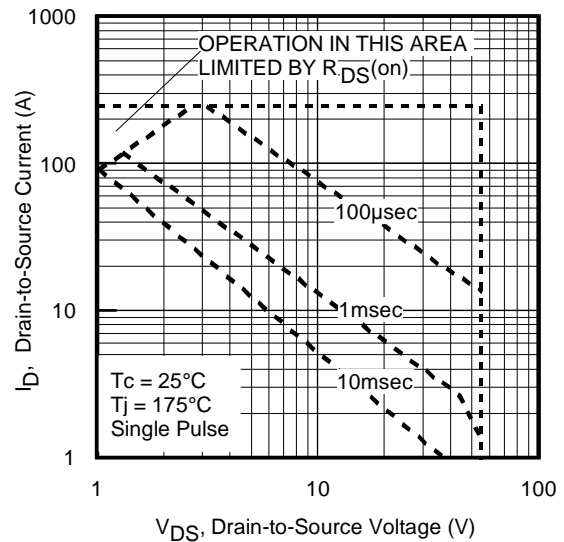

**Fig 8.** Maximum Safe Operating Area

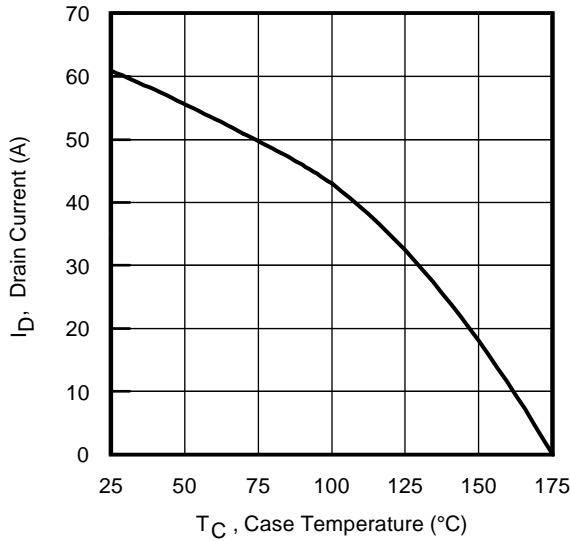

**Fig 9.** Maximum Drain Current vs. Case Temperature

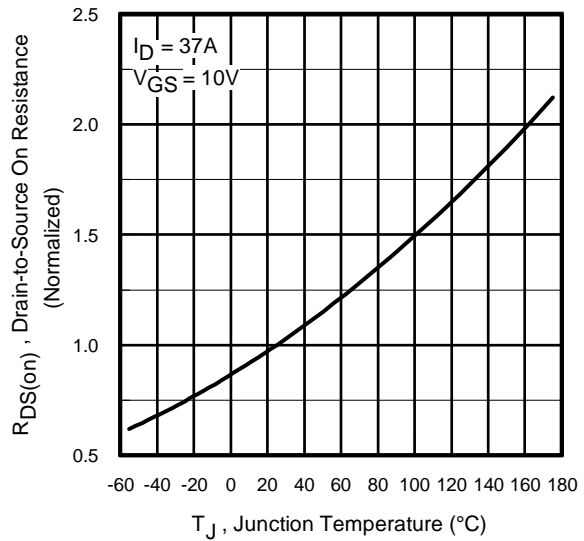

**Fig 10.** Normalized On-Resistance vs. Temperature

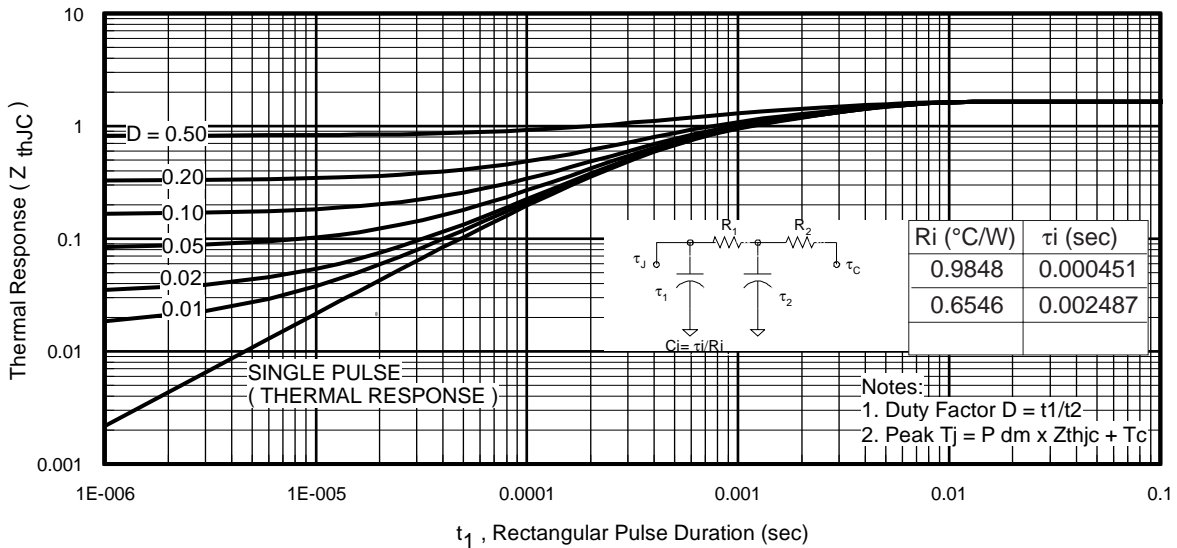

**Fig 11.** Maximum Effective Transient Thermal Impedance, Junction-to-Case

# IRFZ48Z/S/L

International  
**IR** Rectifier

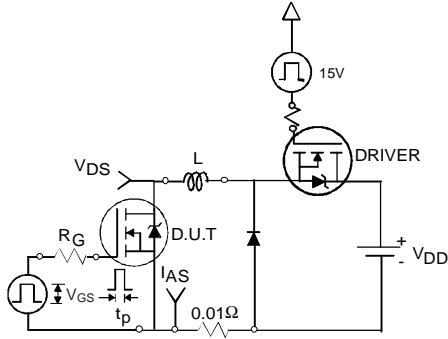

**Fig 12a.** Unclamped Inductive Test Circuit

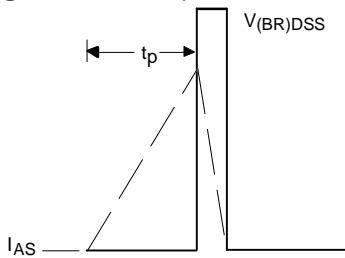

**Fig 12b.** Unclamped Inductive Waveforms

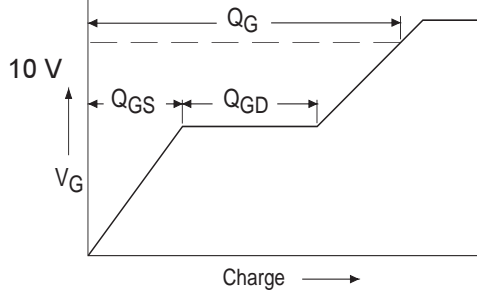

**Fig 13a.** Basic Gate Charge Waveform

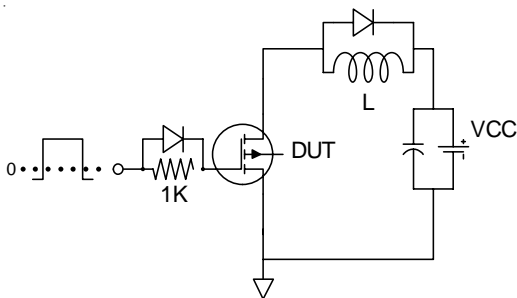

**Fig 13b.** Gate Charge Test Circuit

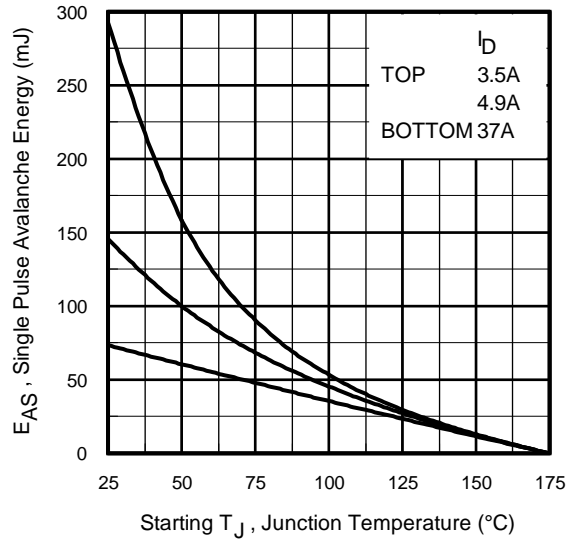

**Fig 12c.** Maximum Avalanche Energy vs. Drain Current

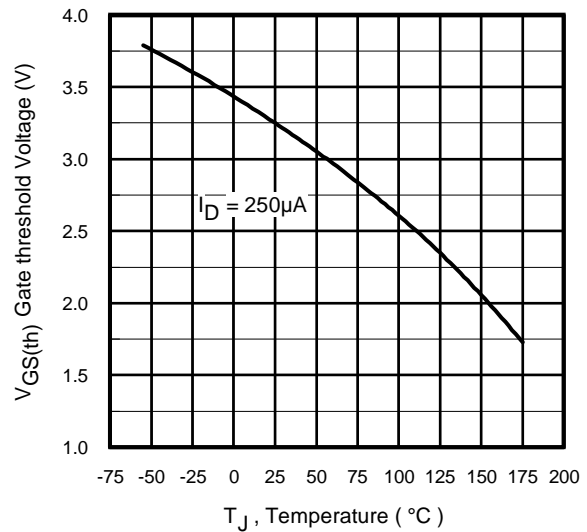

**Fig 14.** Threshold Voltage vs. Temperature

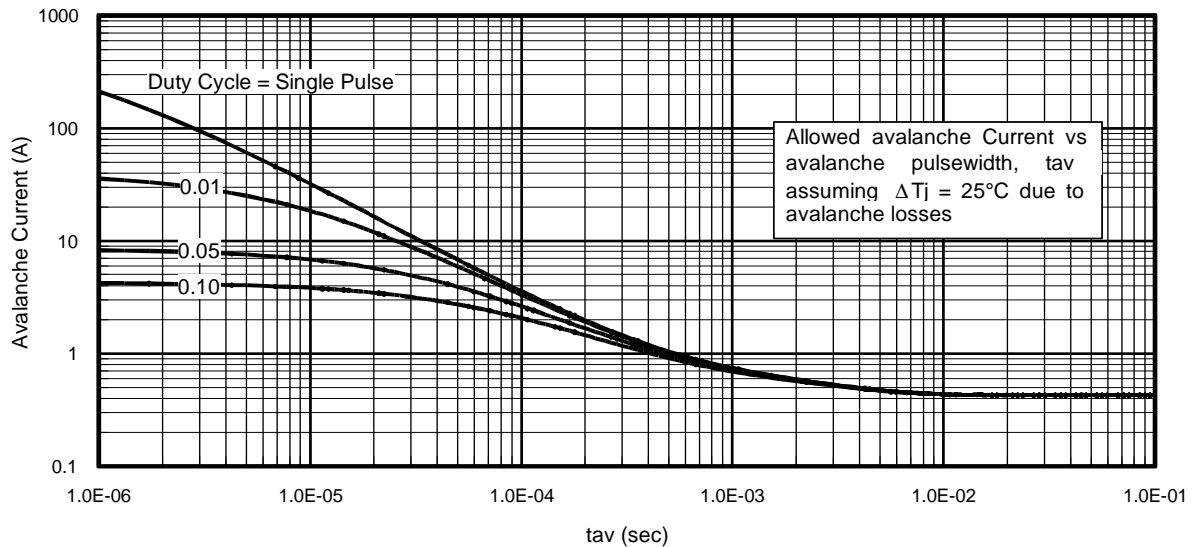

Fig 15. Typical Avalanche Current vs.Pulsewidth

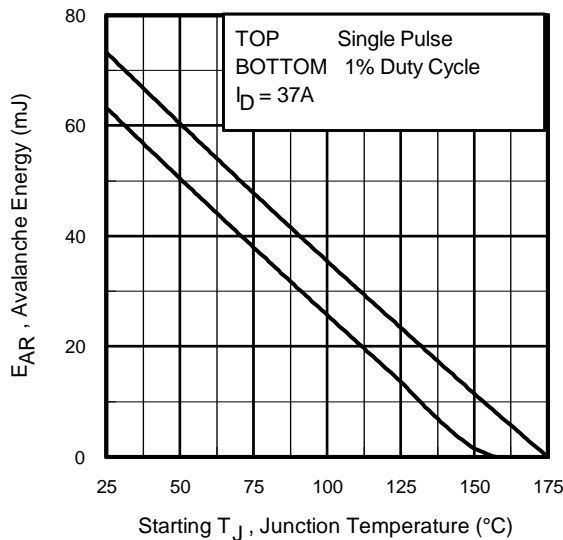

Fig 16. Maximum Avalanche Energy vs. Temperature

**Notes on Repetitive Avalanche Curves , Figures 15, 16:**  
(For further info, see AN-1005 at [www.irf.com](http://www.irf.com))

1. Avalanche failures assumption:  
Purely a thermal phenomenon and failure occurs at a temperature far in excess of  $T_{jmax}$ . This is validated for every part type.
2. Safe operation in Avalanche is allowed as long as  $T_{jmax}$  is not exceeded.
3. Equation below based on circuit and waveforms shown in Figures 12a, 12b.
4.  $P_{D(ave)}$  = Average power dissipation per single avalanche pulse.
5. BV = Rated breakdown voltage (1.3 factor accounts for voltage increase during avalanche).
6.  $I_{av}$  = Allowable avalanche current.
7.  $\Delta T$  = Allowable rise in junction temperature, not to exceed  $T_{jmax}$  (assumed as 25°C in Figure 15, 16).  
 $t_{av}$  = Average time in avalanche.  
 $D$  = Duty cycle in avalanche =  $t_{av} \cdot f$   
 $Z_{thJC}(D, t_{av})$  = Transient thermal resistance, see figure 11)

$$P_{D(ave)} = 1/2 ( 1.3 \cdot BV \cdot I_{av} ) = \Delta T / Z_{thJC}$$

$$I_{av} = 2\Delta T / [1.3 \cdot BV \cdot Z_{th}]$$

$$E_{AS(AR)} = P_{D(ave)} \cdot t_{av}$$

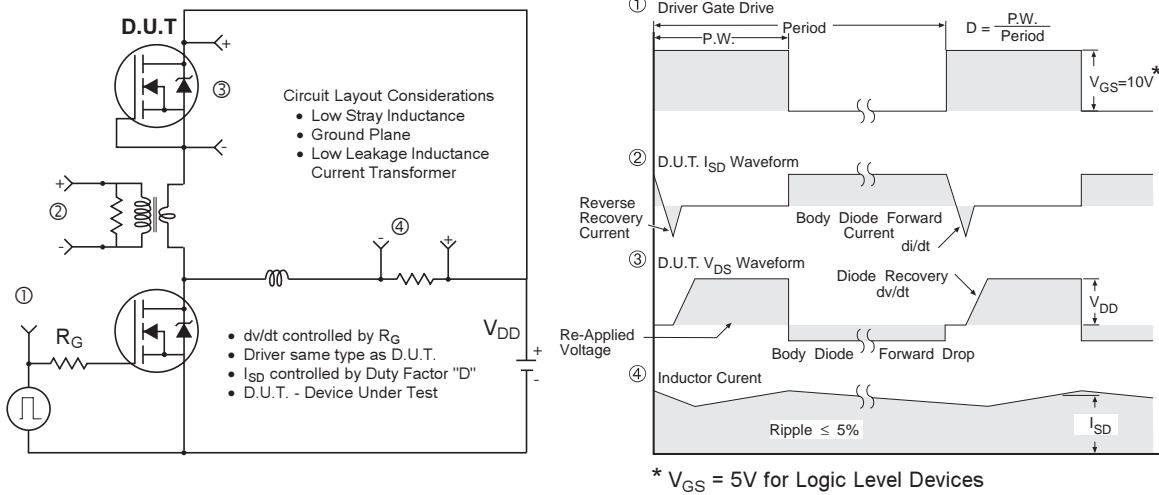

**Fig 17. Peak Diode Recovery  $dv/dt$  Test Circuit for N-Channel HEXFET® Power MOSFETs**

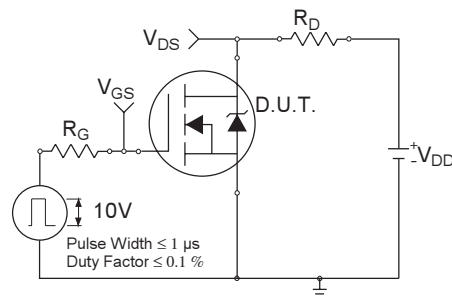

**Fig 18a. Switching Time Test Circuit**

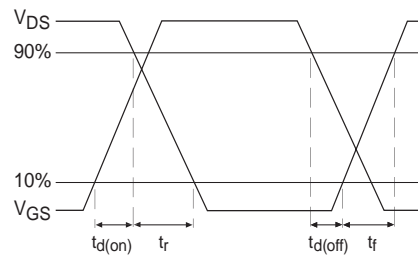
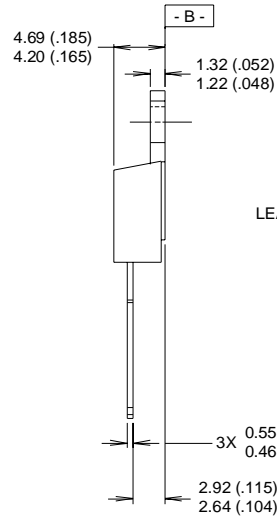
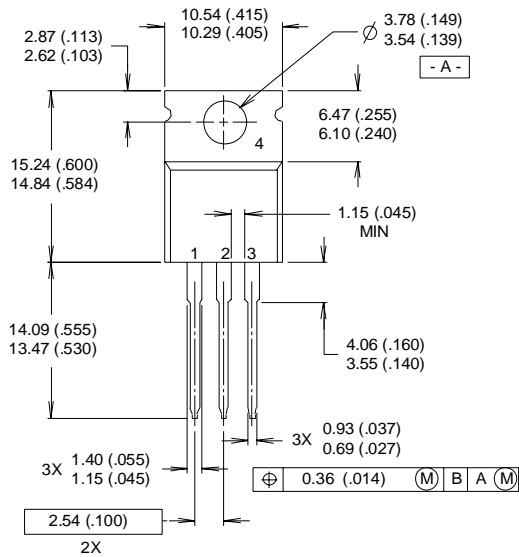

**Fig 18b. Switching Time Waveforms**



## TO-220AB Package Outline

Dimensions are shown in millimeters (inches)



**LEAD ASSIGNMENTS**

- 1 - GATE
- 2 - DRAIN
- 3 - SOURCE
- 4 - DRAIN

**NOTES:**

- 1 DIMENSIONING & TOLERANCING PER ANSI Y14.5M, 1982.
- 2 CONTROLLING DIMENSION : INCH
- 3 OUTLINE CONFORMS TO JEDEC OUTLINE TO-220AB.
- 4 HEATSINK & LEAD MEASUREMENTS DO NOT INCLUDE BURRS.

## TO-220AB Part Marking Information

EXAMPLE: THIS IS AN IRF1010  
LOT CODE 1789  
ASSEMBLED ON VW 19, 1997  
IN THE ASSEMBLY LINE "C"

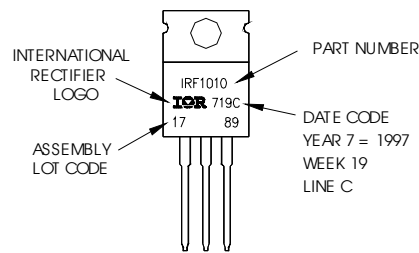

**For GB Production**

EXAMPLE: THIS IS AN IRF1010  
LOT CODE 1789  
ASSEMBLED ON VW 19, 1997  
IN THE ASSEMBLY LINE "C"

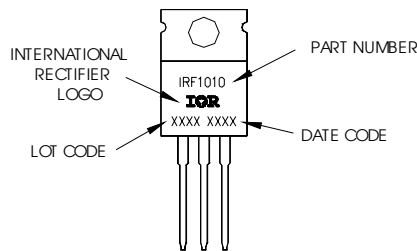

# IRFZ48Z/S/L

International  
**IR** Rectifier

## D<sup>2</sup>Pak Package Outline

Dimensions are shown in millimeters (inches)

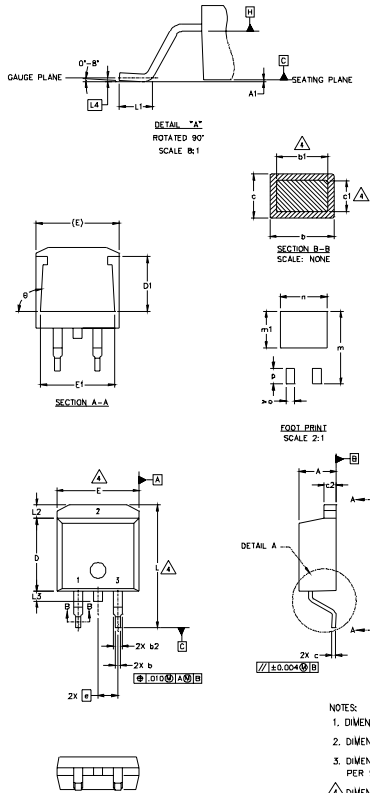

SYMBOL	DIMENSIONS				NOTES
	MILLIMETERS		INCHES		
	MIN.	MAX.	MIN.	MAX.	
A	4.06	4.83	.160	.190	4
A1		0.127		.005	
b	0.51	0.99	.020	.039	
b1	0.51	0.89	.020	.035	
b2	1.14	1.40	.045	.055	4
c	0.43	0.63	.017	.025	
c1	0.38	0.74	.015	.029	
c2	1.14	1.40	.045	.055	
D	8.51	9.65	.335	.380	3
D1	5.33		.210		3
E	9.65	10.67	.380	.420	
E1	6.22		.245		
e	2.54 BSC		.100 BSC		
L	14.61	15.88	.575	.625	
L1	1.78	2.79	.070	.110	
L2		1.65		.065	
L3	1.27	1.78	.050	.070	
L4	0.25 BSC		.010 BSC		
m	17.78		.700		
m1	8.89		.350		
n	11.43		.450		
o	2.08		.082		
p	3.81		.150		
theta	90°	93°	90°	93°	

### LEAD ASSIGNMENTS

HEXFET	IGBTs, CoPACK	DIODES
1 - GATE	1 - GATE	1 - ANODE *
2 - DRAIN	2 - COLLECTOR	2 - CATHODE
3 - SOURCE	3 - EMITTER	3 - ANODE

\* PART DEPENDENT.

- NOTES:
- DIMENSIONING AND TOLERANCING PER ASME Y14.5M-1994
  - DIMENSIONS ARE SHOWN IN MILLIMETERS [INCHES]
  - DIMENSION D & E DO NOT INCLUDE MOLD FLASH. MOLD FLASH SHALL NOT EXCEED 0.127 [0.005"] PER SIDE. THESE DIMENSIONS ARE MEASURED AT THE OUTMOST EXTREMES OF THE PLASTIC BODY.
  - DIMENSION b1 AND c1 APPLY TO BASE METAL ONLY.
  - CONTROLLING DIMENSION: INCH.

## D<sup>2</sup>Pak Part Marking Information

EXAMPLE: THIS IS AN IRF530S WITH  
LOT CODE 8024  
ASSEMBLED ON WW02, 2000  
IN THE ASSEMBLY LINE "L"

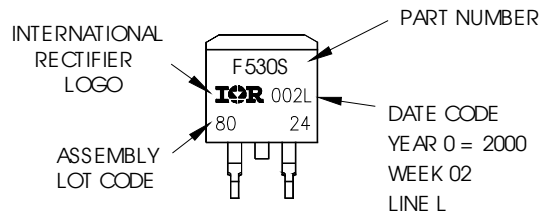

For GB Production  
EXAMPLE: THIS IS AN IRF530S WITH  
LOT CODE 8024  
ASSEMBLED ON WW02, 2000  
IN THE ASSEMBLY LINE "L"

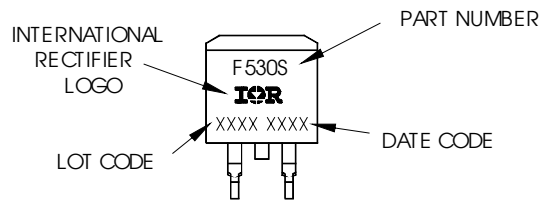

International  
**IR Rectifier**  
**TO-262 Package Outline**  
 Dimensions are shown in millimeters (inches)

# IRFZ48Z/S/L

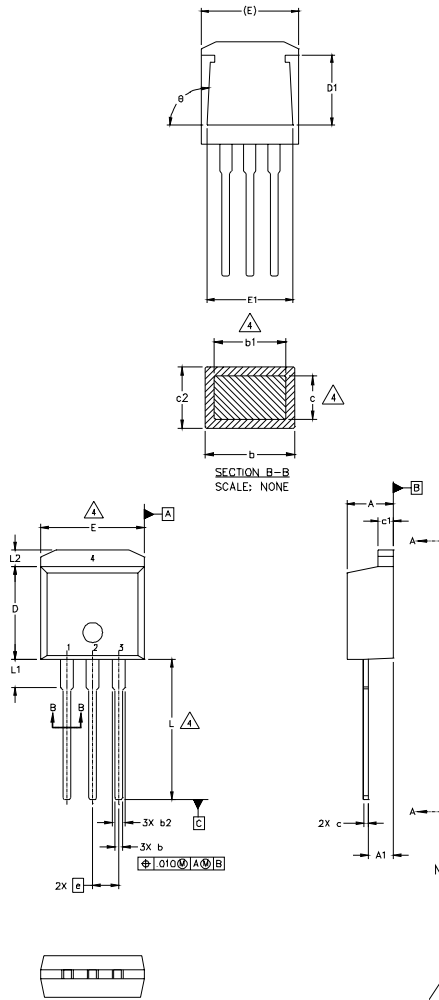

SYMBOL	DIMENSIONS				NOTES
	MILLIMETERS		INCHES		
	MIN.	MAX.	MIN.	MAX.	
A	4.06	4.83	.160	.190	
A1	2.03	2.92	.080	.115	
b	0.51	0.99	.020	.039	
b1	0.51	0.89	.020	.035	4
b2	1.14	1.40	.045	.055	
c	0.38	0.63	.015	.025	4
c1	1.14	1.40	.045	.055	
c2	0.43	.063	.017	.029	
D	8.51	9.65	.335	.380	3
D1	5.33		.210		
E	9.65	10.67	.380	.420	3
E1	6.22		.245		
e	2.54 BSC		.100 BSC		
L	13.46	14.09	.530	.555	
L1	3.56	3.71	.140	.146	
L2		1.65		.065	

LEAD ASSIGNMENTS

HEXFET

- 1.- GATE
- 2.- DRAIN
- 3.- SOURCE
- 4.- DRAIN

IGBT

- 1- GATE
- 2- COLLECTOR
- 3- EMITTER

NOTES:

1. DIMENSIONING AND TOLERANCING PER ASME Y14.5M-1994
2. DIMENSIONS ARE SHOWN IN MILLIMETERS [INCHES].
3. DIMENSION D & E DO NOT INCLUDE MOLD FLASH. MOLD FLASH SHALL NOT EXCEED 0.127 [.005"] PER SIDE. THESE DIMENSIONS ARE MEASURED AT THE OUTMOST EXTREMES OF THE PLASTIC BODY.
4. DIMENSION b1 AND c1 APPLY TO BASE METAL ONLY.
5. CONTROLLING DIMENSION: INCH.

## TO-262 Part Marking Information

EXAMPLE: THIS IS AN IRL3103L  
 LOT CODE 1789  
 ASSEMBLED ON WW 19, 1997  
 IN THE ASSEMBLY LINE "C"

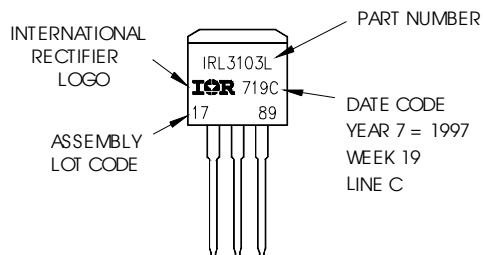

# IRFZ48Z/S/L

International  
**IR** Rectifier

## D<sup>2</sup>Pak Tape & Reel Information

Dimensions are shown in millimeters (inches)

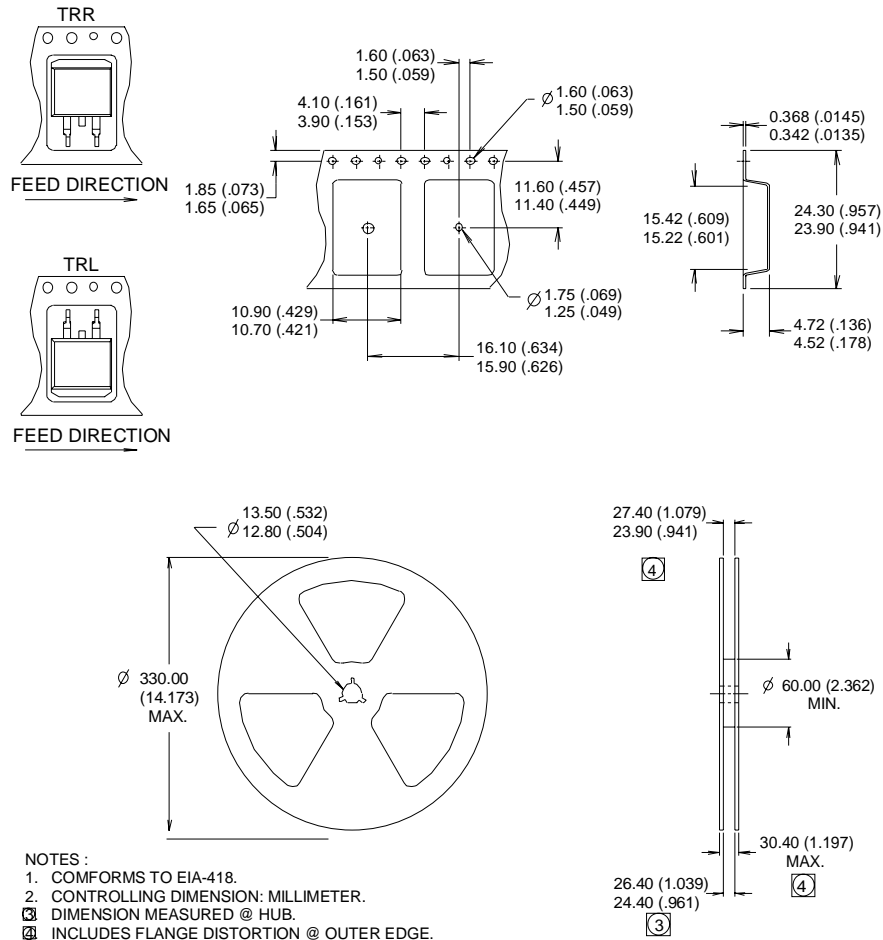

**TO-220AB package is not recommended for Surface Mount Application.**

Data and specifications subject to change without notice.  
This product has been designed and qualified for the Automotive [Q101] market.  
Qualification Standards can be found on IR's Web site.

International  
**IR** Rectifier

**IR WORLD HEADQUARTERS:** 233 Kansas St., El Segundo, California 90245, USA Tel: (310) 252-7105  
TAC Fax: (310) 252-7903  
Visit us at [www.irf.com](http://www.irf.com) for sales contact information. 08/03