

PC9D10

Ultra-high Speed Response, 2-channel OPIC Photocoupler

■ Features

1. Built-in 2-channel
2. Ultra-high speed response
(t_{PHL} , t_{PLH} : TYP. 50ns at $R_L = 350\Omega$)
3. Isolation voltage between input and output
(V_{ISO} : 2 500V_{rms})
4. Low input current drive (I_{FHL} : MAX. 5mA)
5. Instantaneous common mode rejection
voltage (CM_H : TYP. 500V/ μ s)
6. Recognized by UL file No. 64380

■ Applications

1. Computer peripherals high speed interface
for microcomputer systems
2. High speed line receivers
3. Digital audio equipment
4. Interface with various data transfer equipment

■ Outline Dimensions

(Unit : mm)

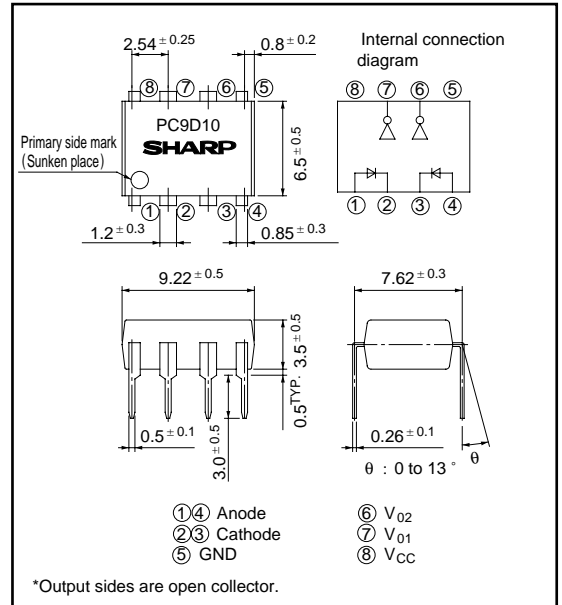

* "OPIC" (Optical IC) is a trademark of the SHARP Corporation.
An OPIC consists of a light-detecting element and signal-processing circuit integrated onto a single chip.

■ Absolute Maximum Ratings

(Ta = 25°C)

Parameter		Symbol	Rating	Unit
Input	*1 *2 Forward current	I_F	15	mA
	*2 Reverse voltage	V_R	5	V
	*1 *2 Power dissipation	P	40	mW
Output	*3 Supply voltage	V_{CC}	7	V
	*2 High level output voltage	V_{OH}	7	V
	*2 Low level output current	I_{OL}	16	mA
	Collector power dissipation	P_C	60	mW
*4 Isolation voltage		V_{iso}	2 500	V _{rms}
Operating temperature		T_{opr}	0 to + 70	°C
Storage temperature		T_{stg}	- 55 to + 125	°C
*5 Soldering temperature		T_{sol}	260	°C

*1 Ta = 0 to 70°C

*2 Each channel

*3 For 1 minute max.

*4 AC for 1 minute, 40 to 60% RH. Apply the specified voltage between the whole of the electrode pins on the input side and the whole of the electrode pins on the output side.

*5 2mm or more away from the lead base for 10 seconds or less

■ Electro-optical Characteristics

(Unless otherwise specified, $T_a = 0$ to $+ 70^{\circ}\text{C}$)

Parameter		Symbol	Conditions	MIN.	TYP.	MAX.	Unit	
Input	Forward voltage	V_F	$T_a = 25^{\circ}\text{C}, I_F = 10\text{mA}$	-	1.6	1.75	V	
	Reverse current	I_R	$T_a = 25^{\circ}\text{C}, V_R = 5\text{V}$	-	-	10	μA	
	Terminal capacitance	C_t	$T_a = 25^{\circ}\text{C}, V = 0, f = 1\text{MHz}$	-	60	250	pF	
Output	High level output current	I_{OH}	$V_{CC} = V_O = 5.5\text{V}, I_F = 250\mu\text{A}$	-	2	250	μA	
	Low level output voltage	V_{OL}	$V_{CC} = 5.5\text{V}, I_F = 5\text{mA}, I_{OL} = 13\text{mA}$	-	0.4	0.6	V	
	High level supply current	I_{CCH}	$V_{CC} = 5.5\text{V}, I_F = 0$	-	14	30	mA	
	Low level supply current	I_{CCL}	$V_{CC} = 5.5\text{V}, I_F = 10\text{mA}$	-	26	36	mA	
Transfer characteristics	“ High→Low ” threshold input current	I_{FHL}	$V_{CC} = 5\text{V}, V_O = 0.8\text{V}, R_L = 350\Omega$	-	2.5	5	mA	
	Isolation resistance	R_{ISO}	$T_a = 25^{\circ}\text{C}, \text{DC}500\text{V}, 40$ to $60\% \text{RH}$	5×10^{10}	10^{11}	-	Ω	
	Floating capacitance	C_f	$T_a = 25^{\circ}\text{C}, V = 0, f = 1\text{MHz}$	-	0.6	-	pF	
	Response time	“ High→Low ” propagation delay time	t_{PHL}	$T_a = 25^{\circ}\text{C}, V_{CC} = 5\text{V}$ Fig.1	-	50	75	ns
		“ Low→High ” propagation delay time	t_{PLH}	$R_L = 350\Omega, C_L = 15\text{pF}$	-	50	75	ns
		Rise time, Fall time	t_r, t_f	$I_F = 7.5\text{mA}$	-	30	60	ns
	CMR	Instantaneous common mode rejection voltage “ High level output ”	CM_H	$T_a = 25^{\circ}\text{C}, V_{CC} = 5\text{V}, V_{O(MIN)} = 2\text{V}$ Fig.2 $V_{CM} = 10\text{V}, R_L = 350\Omega, I_F = 0$	100	500	-	V/ μs
Instantaneous common mode rejection voltage “ Low level output ”		CM_L	Fig.2 $T_a = 25^{\circ}\text{C}, V_{CC} = 5\text{V}, V_{O(MAX)} = 0.8\text{V}$ $V_{CM} = 10\text{V}, R_L = 350\Omega, I_F = 5\text{mA}$	- 100	- 500	-	V/ μs	

All typical values : at $T_a = 25^{\circ}\text{C}, V_{CC} = 5\text{V}$

■ Recommended Operating Conditions

Parameter	Symbol	MIN.	MAX.	Unit
Low level input current	I_{FL}	0	250	μA
High level input current	I_{FH}	7	15	mA
Supply voltage	V_{CC}	4.5	5.5	V
Fanout (TTL load)	N	-	8	-
Operating temperature	T_{opr}	0	70	$^{\circ}\text{C}$

Connect a ceramic by-pass capacitor (0.01 to $0.1\mu\text{F}$) between V_{CC} and GND at the position within 1cm from pin.

Fig. 1 Test Circuit for t_{PHL} , t_{PLH} , t_r and t_f

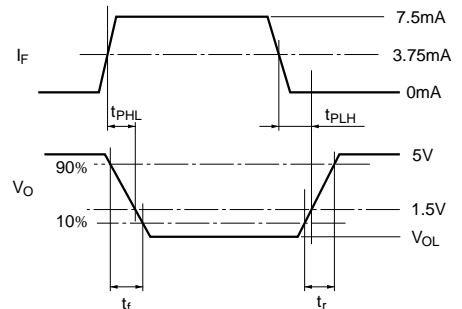
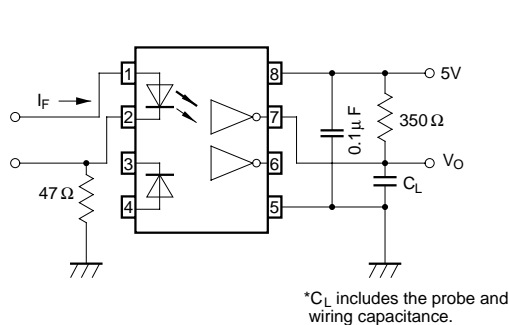

Fig. 2 Test Circuit for CM_H and CM_L

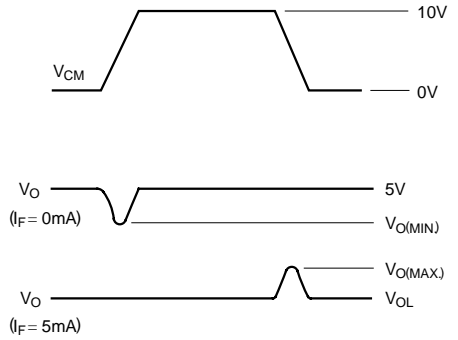
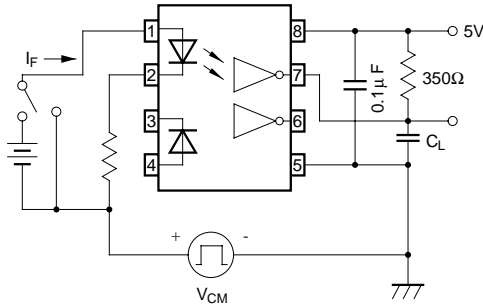

Fig. 3 Collector Power Dissipation vs. Ambient Temperature

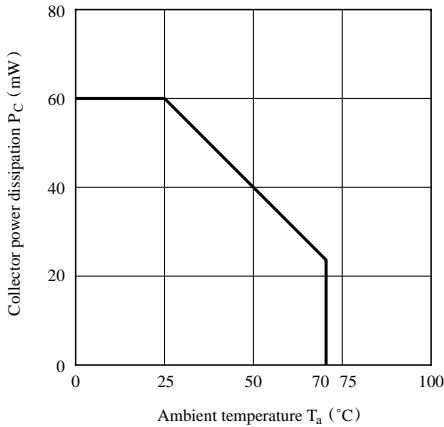

Fig. 4 Forward Current vs. Forward Voltage

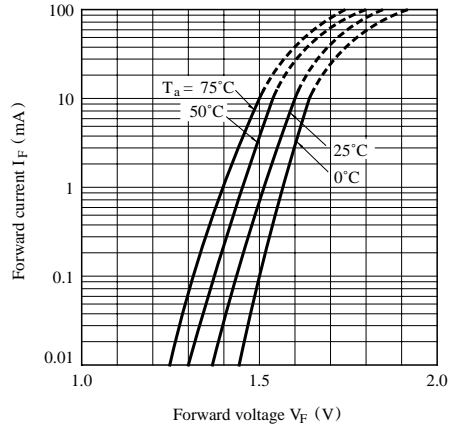

Fig. 5 High Level Output Current vs. Ambient Temperature

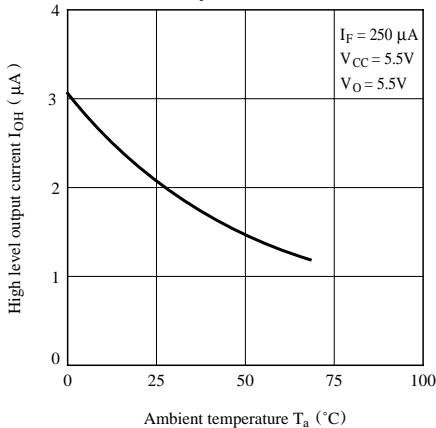

Fig. 6 Low Level Output Voltage vs. Ambient Temperature

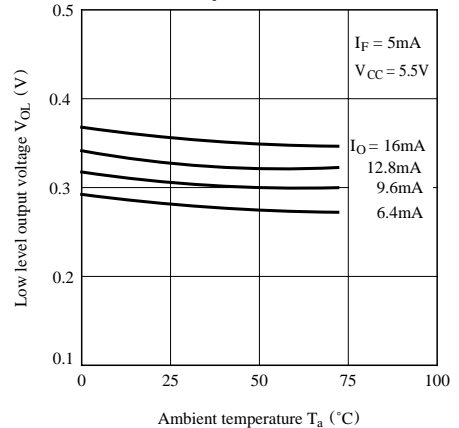

Fig. 7-a Output Voltage vs. Forward Current

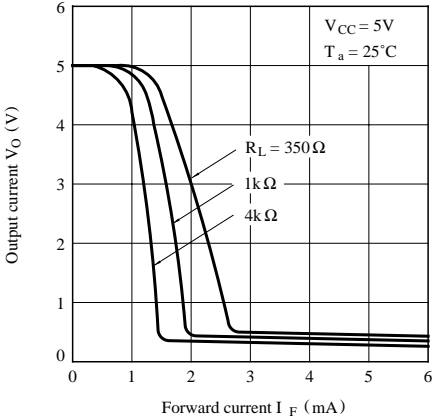

Fig. 7-b Output Voltage vs. Forward Current (Ambient Temp. Characteristics)

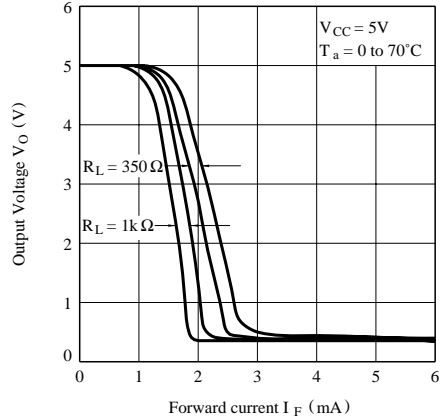

Fig. 8 Propagation Delay Time vs. Forward Current

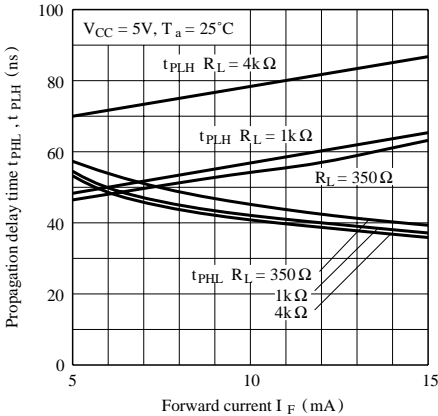

Fig. 9 Propagation Delay Time vs. Ambient Temperature

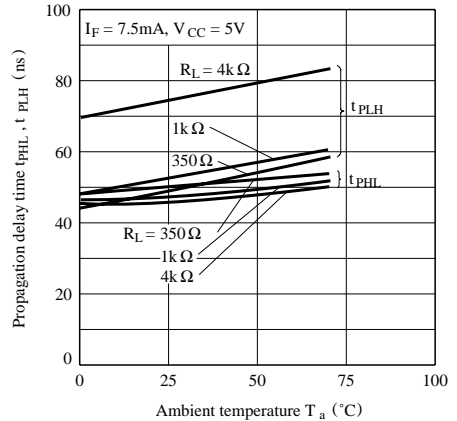
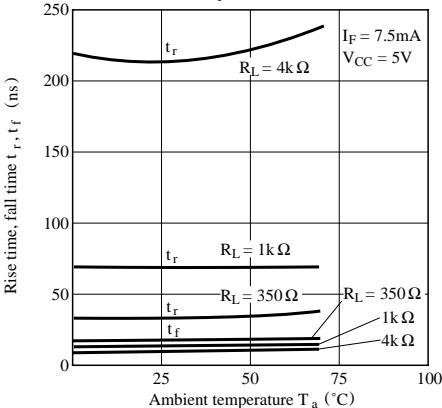

Fig. 10 Rise Time, Fall Time vs. Ambient Temperature



■ Precautions for Use

- (1) Handle this product the same as with other integrated circuits against static electricity.
- (2) As for other general cautions, refer to the chapter "Precautions for Use"