

DATA SHEET

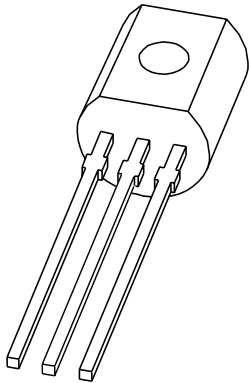

PBSS4350S

50 V low V_{CEsat} NPN transistor

Product specification

2001 Nov 19

50 V low V_{CEsat} NPN transistor

PBSS4350S

FEATURES

- High power dissipation (830 mW)
- Ultra low collector-emitter saturation voltage
- 3 A continuous current
- High current switching
- Improved device reliability due to reduced heat generation

APPLICATIONS

- Medium power switching and muting
- Linear regulators
- DC/DC convertor
- Supply line switching circuits
- Battery management applications
- Strobe flash units
- Heavy duty battery powered equipment (motor and lamp drivers).

DESCRIPTION

NPN low V_{CEsat} transistor in a SOT54 plastic package.
PNP complement: PBSS5350S.

MARKING

TYPE NUMBER	MARKING CODE
PBSS4350S	S4350S

QUICK REFERENCE DATA

SYMBOL	PARAMETER	MAX.	UNIT
V_{CEO}	collector-emitter voltage	50	V
I_C	collector current (DC)	3	A
I_{CM}	peak collector current	5	A
R_{CEsat}	equivalent on-resistance	<145	m Ω

PINNING

PIN	DESCRIPTION
1	base
2	collector
3	emitter

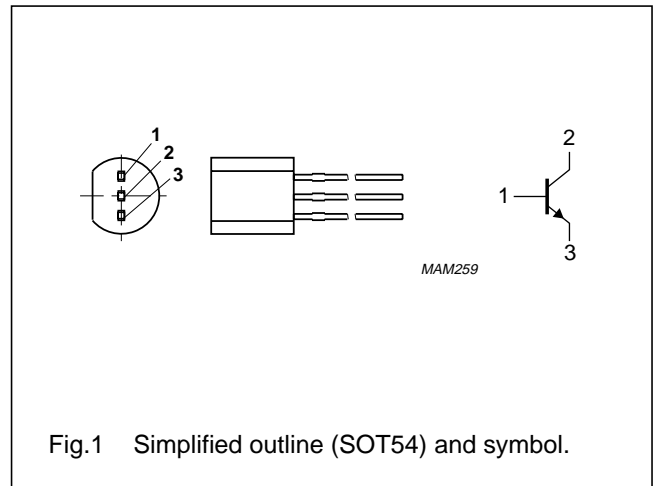

Fig.1 Simplified outline (SOT54) and symbol.

LIMITING VALUES

In accordance with the Absolute Maximum Rating System (IEC 60134).

SYMBOL	PARAMETER	CONDITIONS	MIN.	MAX.	UNIT
V_{CBO}	collector-base voltage	open emitter	–	60	V
V_{CEO}	collector-emitter voltage	open base	–	50	V
V_{EBO}	emitter-base voltage	open collector	–	6	V
I_C	collector current (DC)		–	3	A
I_{CM}	peak collector current		–	5	A
I_{BM}	peak base current		–	1	A
P_{tot}	total power dissipation	$T_{amb} \leq 25\text{ }^\circ\text{C}$; note 1	–	830	mW
T_{stg}	storage temperature		–65	+150	$^\circ\text{C}$
T_j	junction temperature		–	150	$^\circ\text{C}$
T_{amb}	operating ambient temperature		–65	+150	$^\circ\text{C}$

Note

1. Device mounted on a printed-circuit board, single sided copper, tinplated and standard footprint.

50 V low V_{CEsat} NPN transistor

PBSS4350S

THERMAL CHARACTERISTICS

SYMBOL	PARAMETER	CONDITIONS	VALUE	UNIT
$R_{th\ j-a}$	thermal resistance from junction to ambient	in free air; note 1	150	K/W

Note

1. Device mounted on a printed-circuit board, single sided copper, tinplated and standard footprint.

CHARACTERISTICS

$T_{amb} = 25\text{ °C}$ unless otherwise specified.

SYMBOL	PARAMETER	CONDITIONS	MIN.	TYP.	MAX.	UNIT
I_{CBO}	collector-base cut-off current	$V_{CB} = 50\text{ V}; I_E = 0$	–	–	100	nA
		$V_{CB} = 50\text{ V}; I_E = 0; T_j = 150\text{ °C}$	–	–	50	μA
I_{EBO}	emitter-base cut-off current	$V_{EB} = 5\text{ V}; I_C = 0$	–	–	100	nA
h_{FE}	DC current gain	$V_{CE} = 2\text{ V}; I_C = 500\text{ mA}$	200	–	–	
		$V_{CE} = 2\text{ V}; I_C = 1\text{ A}; \text{note 1}$	200	–	–	
		$V_{CE} = 2\text{ V}; I_C = 2\text{ A}; \text{note 1}$	100	–	–	
V_{CEsat}	collector-emitter saturation voltage	$I_C = 500\text{ mA}; I_B = 50\text{ mA}$	–	–	90	mV
		$I_C = 1\text{ A}; I_B = 50\text{ mA}$	–	–	170	mV
		$I_C = 2\text{ A}; I_B = 200\text{ mA}; \text{note 1}$	–	–	290	mV
R_{CEsat}	equivalent on-resistance	$I_C = 2\text{ A}; I_B = 200\text{ mA}; \text{note 1}$	–	110	<145	$\text{m}\Omega$
V_{BEsat}	base-emitter saturation voltage	$I_C = 2\text{ A}; I_B = 200\text{ mA}; \text{note 1}$	–	–	1.2	V
V_{BEon}	base-emitter turn-on voltage	$V_{CE} = 2\text{ V}; I_C = 1\text{ A}; \text{note 1}$	–	–	1.1	V
f_T	transition frequency	$I_C = 100\text{ mA}; V_{CE} = 5\text{ V}; f = 100\text{ MHz}$	100	–	–	MHz
C_c	collector capacitance	$V_{CB} = 10\text{ V}; I_E = I_e = 0; f = 1\text{ MHz}$	–	–	30	pF

Note

1. Pulse test: $t_p \leq 300\text{ }\mu\text{s}$; $\delta \leq 0.02$.

50 V low V_{CEsat} NPN transistor

PBSS4350S

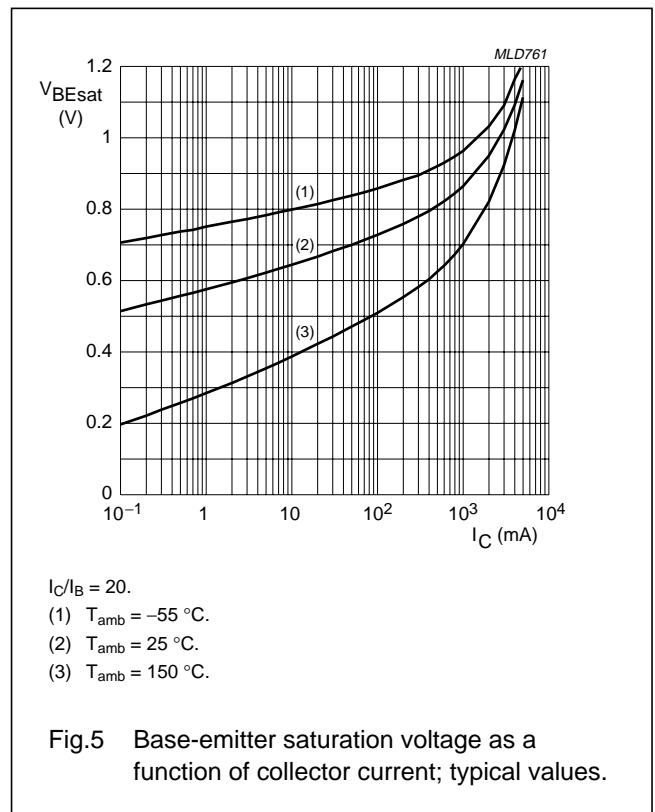
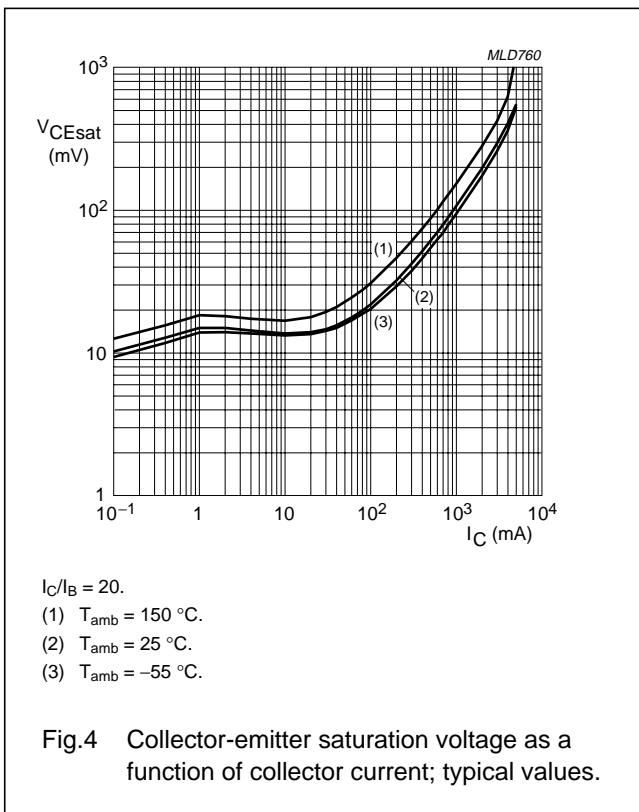
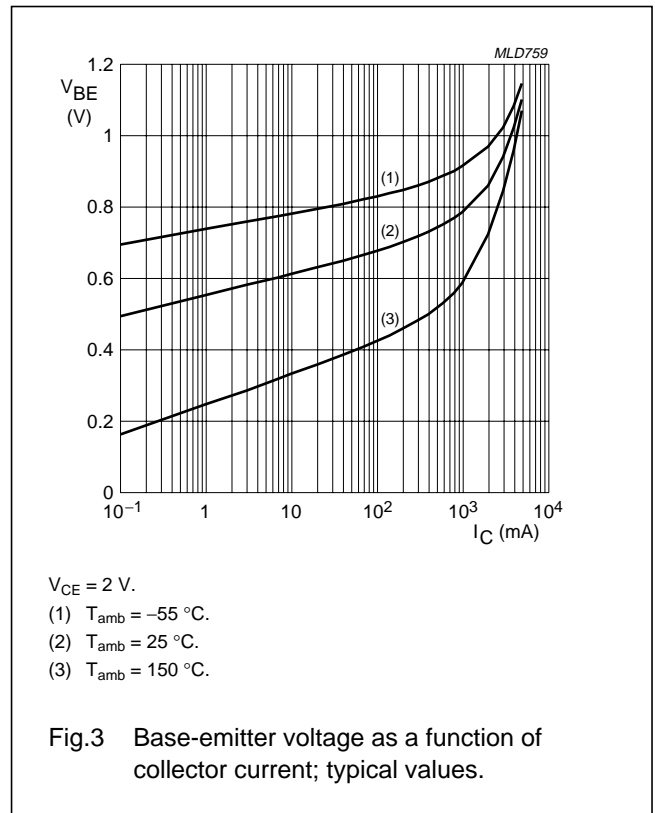
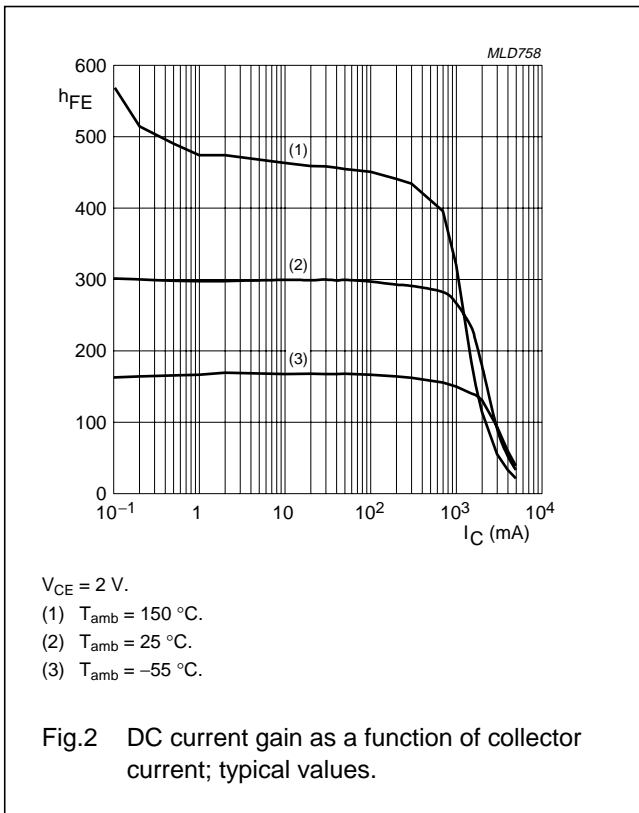

50 V low V_{CEsat} NPN transistor

PBSS4350S

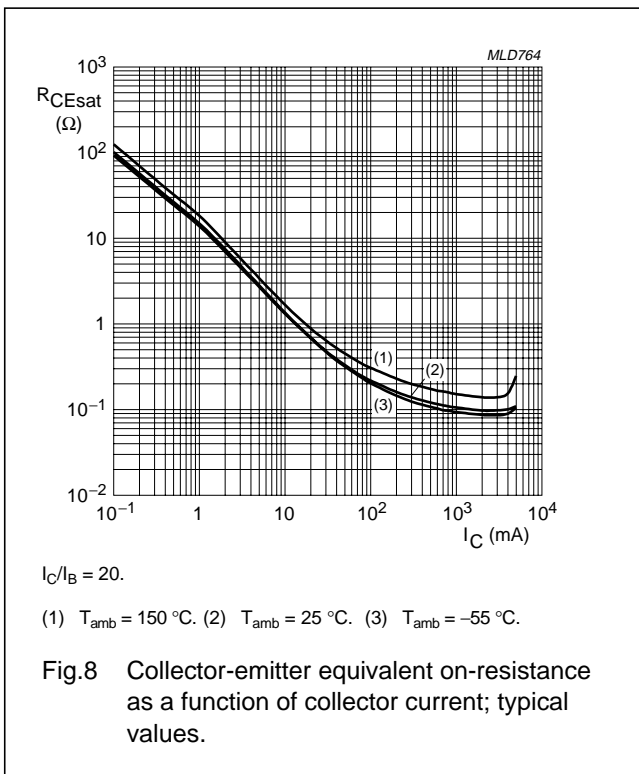
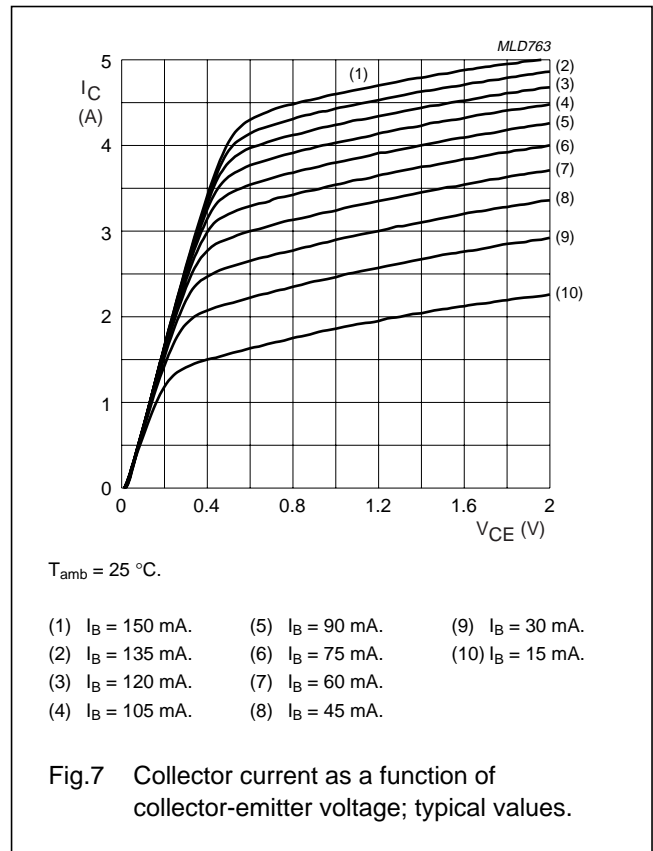
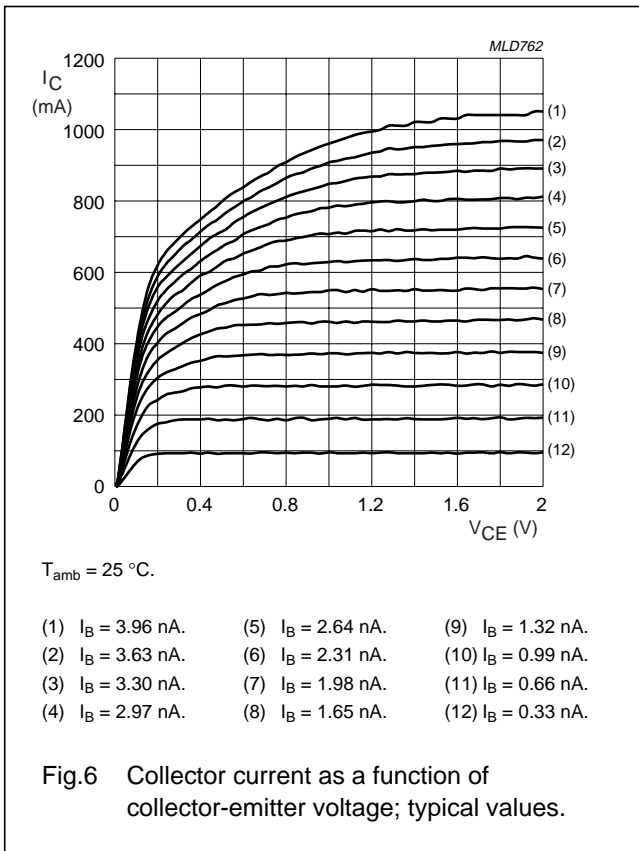

50 V low V_{CEsat} NPN transistor

PBSS4350S

PACKAGE OUTLINE

Plastic single-ended leaded (through hole) package; 3 leads

SOT54

0 2.5 5 mm
scale

DIMENSIONS (mm are the original dimensions)

UNIT	A	b	b ₁	c	D	d	E	e	e ₁	L	L ₁ ⁽¹⁾
mm	5.2 5.0	0.48 0.40	0.66 0.56	0.45 0.40	4.8 4.4	1.7 1.4	4.2 3.6	2.54	1.27	14.5 12.7	2.5

Note
1. Terminal dimensions within this zone are uncontrolled to allow for flow of plastic and terminal irregularities.

OUTLINE VERSION	REFERENCES			EUROPEAN PROJECTION	ISSUE DATE
	IEC	JEDEC	EIAJ		
SOT54		TO-92	SC-43		97-02-28

50 V low V_{CEsat} NPN transistor

PBSS4350S

DATA SHEET STATUS

DATA SHEET STATUS ⁽¹⁾	PRODUCT STATUS ⁽²⁾	DEFINITIONS
Objective data	Development	This data sheet contains data from the objective specification for product development. Philips Semiconductors reserves the right to change the specification in any manner without notice.
Preliminary data	Qualification	This data sheet contains data from the preliminary specification. Supplementary data will be published at a later date. Philips Semiconductors reserves the right to change the specification without notice, in order to improve the design and supply the best possible product.
Product data	Production	This data sheet contains data from the product specification. Philips Semiconductors reserves the right to make changes at any time in order to improve the design, manufacturing and supply. Changes will be communicated according to the Customer Product/Process Change Notification (CPCN) procedure SNW-SQ-650A.

Notes

1. Please consult the most recently issued data sheet before initiating or completing a design.
2. The product status of the device(s) described in this data sheet may have changed since this data sheet was published. The latest information is available on the Internet at URL <http://www.semiconductors.philips.com>.

DEFINITIONS

Short-form specification — The data in a short-form specification is extracted from a full data sheet with the same type number and title. For detailed information see the relevant data sheet or data handbook.

Limiting values definition — Limiting values given are in accordance with the Absolute Maximum Rating System (IEC 60134). Stress above one or more of the limiting values may cause permanent damage to the device. These are stress ratings only and operation of the device at these or at any other conditions above those given in the Characteristics sections of the specification is not implied. Exposure to limiting values for extended periods may affect device reliability.

Application information — Applications that are described herein for any of these products are for illustrative purposes only. Philips Semiconductors make no representation or warranty that such applications will be suitable for the specified use without further testing or modification.

DISCLAIMERS

Life support applications — These products are not designed for use in life support appliances, devices, or systems where malfunction of these products can reasonably be expected to result in personal injury. Philips Semiconductors customers using or selling these products for use in such applications do so at their own risk and agree to fully indemnify Philips Semiconductors for any damages resulting from such application.

Right to make changes — Philips Semiconductors reserves the right to make changes, without notice, in the products, including circuits, standard cells, and/or software, described or contained herein in order to improve design and/or performance. Philips Semiconductors assumes no responsibility or liability for the use of any of these products, conveys no licence or title under any patent, copyright, or mask work right to these products, and makes no representations or warranties that these products are free from patent, copyright, or mask work right infringement, unless otherwise specified.

Philips Semiconductors – a worldwide company

Contact information

For additional information please visit <http://www.semiconductors.philips.com>. Fax: +31 40 27 24825

For sales offices addresses send e-mail to: sales.addresses@www.semiconductors.philips.com.

© Koninklijke Philips Electronics N.V. 2001

SCA73

All rights are reserved. Reproduction in whole or in part is prohibited without the prior written consent of the copyright owner.

The information presented in this document does not form part of any quotation or contract, is believed to be accurate and reliable and may be changed without notice. No liability will be accepted by the publisher for any consequence of its use. Publication thereof does not convey nor imply any license under patent- or other industrial or intellectual property rights.

Printed in The Netherlands

613514/01/pp8

Date of release: 2001 Nov 19

Document order number: 9397 750 08945

Let's make things better.

**Philips
Semiconductors**



PHILIPS