

AD1857/AD1858

FEATURES

Low Cost, High Performance Stereo DACs
 128 Times Oversampling Interpolation Filter
 Multibit $\Sigma\Delta$ Modulator with Triangular PDF Dither
 Discrete Time and Continuous Time Analog Reconstruction Filters
 Extremely Low Out-of-Band Energy
 Buffered Outputs with 2 k Ω Output Load Drive
 94 dB Dynamic Range, -90 dB THD+N Performance
 Digital De-emphasis and Mute
 $\pm 0.1^\circ\text{C}$ Maximum Phase Linearity Deviation
 Continuously Variable Sample Rate Support
 Power-Down Mode
 16-, 18- and 20-Bit I²S-Justified, Left-Justified Modes
 Offered on AD1857
 Accepts 24-Bit Word
 16-Bit Right-Justified and DSP Serial Port Modes
 Offered on AD1858
 Single +5 V Supply
 20-Pin SSOP Package

APPLICATIONS

Digital Cable TV and Direct Broadcast Satellite Set-Top Decoder Boxes
 Video Laser Disk, Video CD and CD-I Players
 High Definition Televisions, Digital Audio Broadcast Receivers
 CD, CD-R, DAT, DCC and MD Players
 Digital Audio Workstations, Computer Multimedia Products

PRODUCT OVERVIEW

The AD1857/AD1858 are complete single-chip stereo digital audio playback components. They each comprise an advanced digital interpolation filter, a revolutionary "linearity-compensated" multibit sigma-delta ($\Sigma\Delta$) modulator with dither, a jitter-tolerant DAC, switched capacitor and continuous time analog filters and analog output drive circuitry. Other features include digital de-emphasis processing and mute. The AD1857/AD1858 support continuously variable sample rates with essentially linear phase response, and support 50/15 μs digital de-emphasis intended for "Redbook" 44.1 kHz sample frequency playback from Compact Discs. The user must provide a master clock that is synchronous with the left/right clock at 256 or 384 times the intended sample frequency.

The AD1857/AD1858 have a simple but very flexible serial data input port that allows for glueless interconnection to a variety of ADCs, DSP chips, AES/EBU receivers and sample rate converters. The AD1857 serial data input port can be configured in either 16-bit, 18-bit or 20-bit left-justified or I²S-justified modes. The AD1858 serial data input port can be configured in either 16-bit right-justified or DSP serial port compatible modes. The AD1857/AD1858 accept serial audio data in MSB first, two's-complement format. A power-down mode is offered to minimize power consumption when the device is inactive. The AD1857/AD1858 operate from a single +5 V power supply. They are fabricated on a single monolithic integrated circuit and housed in 20-pin SSOP packages for operation over the temperature range 0°C to +70°C.

FUNCTIONAL BLOCK DIAGRAM

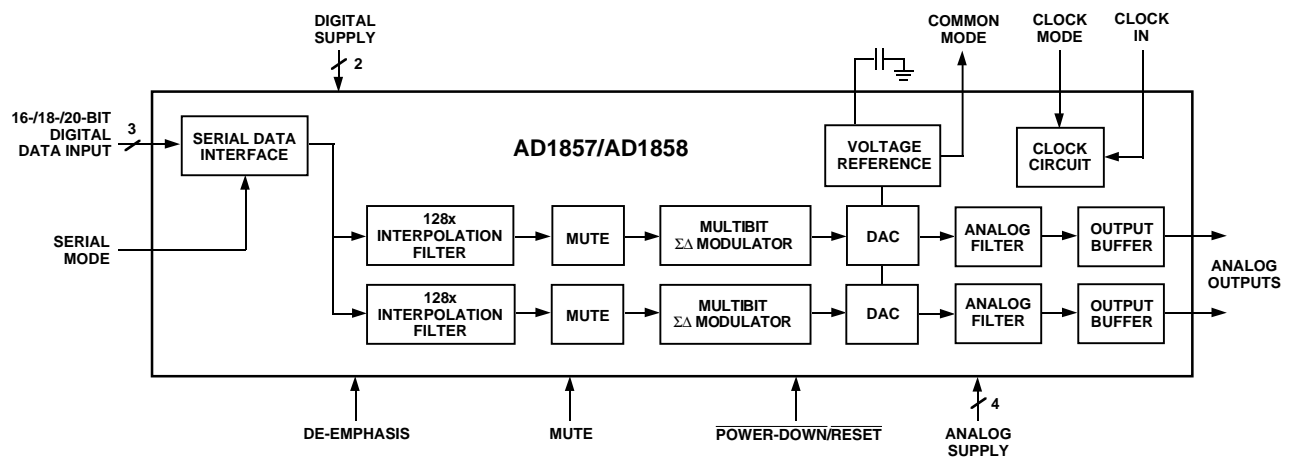

REV. 0

Information furnished by Analog Devices is believed to be accurate and reliable. However, no responsibility is assumed by Analog Devices for its use, nor for any infringements of patents or other rights of third parties which may result from its use. No license is granted by implication or otherwise under any patent or patent rights of Analog Devices.

One Technology Way, P.O. Box 9106, Norwood, MA 02062-9106, U.S.A.
 Tel: 617/329-4700 World Wide Web Site: <http://www.analog.com>
 Fax: 617/326-8703 © Analog Devices, Inc., 1997

AD1857/AD1858—SPECIFICATIONS

TEST CONDITIONS UNLESS OTHERWISE NOTED

Supply Voltages (V_{DD} , DV_{DD})	+5.0 V
Ambient Temperature	25°C
Input Clock (F_{MCLK})	11.2896 MHz ($256 \times F_S$ Mode)
Input Signal	1.0013 kHz
	-0.5 dB Full Scale
Input Sample Rate	44.1 kHz
Measurement Bandwidth	20 Hz to 20 kHz
AD1857 Input Data Wordwidth	18 Bits
AD1858 Input Data Wordwidth	16 Bits
Load Capacitance	100 pF
Load Impedance	47 k Ω
Input Voltage HI (V_{IH})	2.4 V
Input Voltage LO (V_{IL})	0.8 V

I²S-Justified Mode (Ref. Figure 7) for AD1857, Right-Justified Mode (Ref. Figure 8) for AD1858.

Performance of the right and left channels are identical (exclusive of the Interchannel Gain Mismatch and Interchannel Phase Deviation specifications).

Values in **bold** typeface are tested, all others are guaranteed, not tested.

ANALOG PERFORMANCE

	Min	Typ	Max	Units
AD1857 Resolution		18		Bits
AD1858 Resolution		16		Bits
Dynamic Range (20 Hz to 20 kHz, -60 dB Input)				
No A-Weight Filter		91		dB
With A-Weight Filter		94		dB
Total Harmonic Distortion + Noise		-90	-85	dB
		0.003	0.006	%
Analog Outputs				
Single-Ended Output Range (\pm Full Scale)	2.8	3.0	3.2	V p-p
Output Impedance at Each Output Pin		<200		Ω
Output Capacitance at Each Output Pin			20	pF
Out-of-Band Energy (0.5 \times F_S to 100 kHz)			-72.5	dB
CMOUT	2.1	2.25	2.4	V
DC Accuracy				
Gain Error		± 3.0	± 7.5	%
Interchannel Gain Mismatch		0.01	± 0.2	dB
Gain Drift		150	300	ppm/°C
Interchannel Crosstalk (EIAJ method)		-120	-100	dB
Interchannel Phase Deviation		± 0.1		Degrees
Mute Attenuation		-100	-90	dB
De-emphasis Gain Error			± 0.1	dB

DIGITAL I/O

	Min	Max	Units
Input Voltage HI (V_{IH})	2.4		V
Input Voltage LO (V_{IL})		0.8	V
Input Leakage (I_{IH} @ $V_{IH} = 2.4$ V)		10	μ A
Input Leakage (I_{IL} @ $V_{IL} = 0.8$ V)		10	μ A
Input Capacitance		20	pF

DIGITAL TIMING (Guaranteed over 0°C to +70°C, $AV_{DD} = DV_{DD} = +5.0\text{ V} \pm 5\%$)

	Min	Max	Units
t_{DML} MCLK LO Pulse Width ($256 \times F_S$ Mode)	35		ns
t_{DMH} MCLK HI Pulse Width ($256 \times F_S$ Mode)	40		ns
t_{DMP} MCLK Period ($256 \times F_S$ Mode)	88.577		ns
t_{DML} MCLK LO Pulse Width ($384 \times F_S$ Mode)	25		ns
t_{DMH} MCLK HI Pulse Width ($384 \times F_S$ Mode)	25		ns
t_{DMP} MCLK Period ($384 \times F_S$ Mode)	59.0514		ns
t_{DBH} BCLK HI Pulse Width	20		ns
t_{DBL} BCLK LO Pulse Width	20		ns
t_{DBP} BCLK Period	354.308		ns
t_{DLS} LRCLK Setup	20		ns
t_{DLH} LRCLK Hold	5		ns
t_{DDS} SDATA Setup	5		ns
t_{DDH} SDATA Hold	10		ns
t_{PDRP} $\overline{PD}/\overline{RST}$ LO Pulse Width	4 MCLK Periods (355 ns @ 11.2896 MHz)		ns

POWER

	Min	Typ	Max	Units
Supplies				
Voltage, Analog and Digital	4.75	5	5.25	V
Analog Current		35	40	mA
Analog Current – Power-Down		30	60	μA
Digital Current		20	25	mA
Digital Current – Power-Down		5	11	mA
Dissipation				
Operation – Both Supplies		275	325	mW
Operation – Analog Supply		175	200	mW
Operation – Digital Supply		100	125	mW
Power-Down – Both Supplies		25	56	mW
Power Supply Rejection Ratio				
1 kHz 300 mV p-p Signal at Analog Supply Pins		-60		dB
20 kHz 300 mV p-p Signal at Analog Supply Pins		-50		dB

TEMPERATURE RANGE

	Min	Typ	Max	Units
Specifications Guaranteed		25		$^{\circ}\text{C}$
Functionality Guaranteed	0		70	$^{\circ}\text{C}$
Storage	-55		125	$^{\circ}\text{C}$

ABSOLUTE MAXIMUM RATINGS*

	Min	Typ	Max	Units
DV_{DD} to DGND	-0.3		6	V
AV_{DD} to AGND	-0.3		6	V
Digital Inputs	DGND - 0.3		$DV_{DD} + 0.3$	V
Analog Outputs	AGND - 0.3		$AV_{DD} + 0.3$	V
AGND to DGND	-0.3		0.3	V
Reference Voltage	Indefinite Short Circuit to Ground			
Soldering			+300	$^{\circ}\text{C}$
			10	sec

*Stresses greater than those listed under Absolute Maximum Ratings may cause permanent damage to the device. This is a stress rating only; functional operation of the device at these or any other conditions above those indicated in the operational section of this specification is not implied. Exposure to absolute maximum rating conditions for extended periods may affect device reliability.

AD1857/AD1858

PACKAGE CHARACTERISTICS

	Min	Typ	Max	Units
θ_{JA} (Thermal Resistance [Junction-to-Ambient])		195		°C/W
θ_{JC} (Thermal Resistance [Junction-to-Case])		13		°C/W

DIGITAL FILTER CHARACTERISTICS

	Min	Max	Units
Passband Ripple		±0.045	dB
Stopband ¹ Attenuation	62		dB
48 kHz F_S			
Passband	0	21.312	kHz
Stopband	26.688	6117	kHz
44.1 kHz F_S			
Passband	0	19.580	kHz
Stopband	24.520	5620	kHz
32 kHz F_S			
Passband	0	14.208	kHz
Stopband	17.792	4078	kHz
Other F_S			
Passband	0	0.444	F_S
Stopband	0.556	127.444	F_S
Group Delay		40/ F_S	sec
Group Delay Variation		0	μ s

ANALOG FILTER CHARACTERISTICS

	Min	Typ	Max	Units
Passband Ripple			-0.075	dB
Stopband Attenuation (at $64 \times F_S$)		58		dB

NOTES

¹Stopband nominally repeats itself at multiples of $128 \times F_S$, where F_S is the input word rate. Thus the digital filter will attenuate to 62 dB across the frequency spectrum, except for a range $\pm 0.55 \times F_S$ wide at multiples of $128 \times F_S$.

Specifications subject to change without notice.

ORDERING GUIDE

Model	Temperature	Package Description	Package Option*
AD1857JRS	0°C to +70°C	20-Lead SSOP	RS-20
AD1857JRSRL	0°C to +70°C	20-Lead SSOP	RS-20 on 13" Reels
AD1858JRS	0°C to +70°C	20-Lead SSOP	RS-20
AD1858JRSRL	0°C to +70°C	20-Lead SSOP	RS-20 on 13" Reels

*RS = Shrink Small Outline

PIN CONFIGURATION

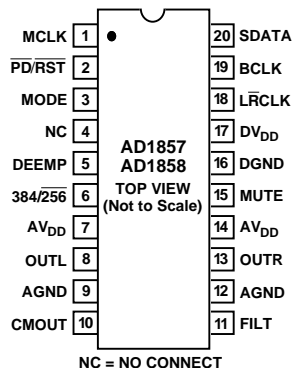

CAUTION

ESD (electrostatic discharge) sensitive device. Electrostatic charges as high as 4000 V readily accumulate on the human body and test equipment and can discharge without detection. Although the AD1857/AD1858 feature proprietary ESD protection circuitry, permanent damage may occur on devices subjected to high energy electrostatic discharges. Therefore, proper ESD precautions are recommended to avoid performance degradation or loss of functionality.



PIN LIST**Digital Audio Serial Input Interfaces**

Pin Name	Number	I/O	Description
SDATA	20	I	Serial input, MSB first, containing two channels of 16, 18 or 20 bits (AD1857) or 16 bits (AD1858) of twos complement data per channel.
BCLK	19	I	Bit clock input for input data. Need not run continuously; may be gated or used in a burst fashion.
LRCLK	18	I	Left/right clock input for input data. Must run continuously.
MODE	3	I	Input serial data port mode control. Selects between I ² S-justified (HI) and left-justified (LO) on the AD1857. Selects between DSP serial port style mode (HI) and right-justified (LO) on the AD1858. The state of the mode pin should be changed only when the AD1857/AD1858 is held in reset ($\overline{PD/RST}$ LO). Otherwise, the AD1857/AD1858 serial port may lose synchronism.

Control and Clock Signals

Pin Name	Number	I/O	Description
$\overline{PD/RST}$	2	I	Power-Down/Reset. The AD1857/AD1858 are placed in a low power consumption "sleep" mode when this pin is held LO. The AD1857/AD1858 are reset on the rising edge of this signal. Connect HI for normal operation.
DEEMP	5	I	De-emphasis. Digital de-emphasis is enabled when this input signal is HI. This is used to impose a 50/15 μ s response characteristic on the output audio spectrum at an assumed 44.1 kHz sample rate.
MUTE	15	I	Mute. Assert HI to mute both stereo analog outputs of the AD1857/AD1858. Deassert LO for normal operation.
MCLK	1	I	Master Clock Input. Connect to an external clock source at either 256 or 384 times the intended sample frequency as determined by the $384/\overline{256}$ pin. Must be synchronous with LRCLK, but may have any phase with respect to LRCLK.
$384/\overline{256}$	6	I	Selects the master clock mode as either 384 times the intended sample frequency (HI) or 256 times the intended sample frequency (LO). The state of this input should be hardwired to logic LO or logic HI or may be changed while the AD1857/AD1858 is in power-down/reset. It must not be changed while the AD1857/AD1858 is operational.

Analog Signals

Pin Name	Number	I/O	Description
FILT	11	O	Voltage Reference Filter Capacitor Connection. Bypass and decouple the voltage reference with parallel 10 μ F and 0.1 μ F capacitors to the AGND pin.
CMOUT	10	O	Voltage Reference Common Mode Output. Should be decoupled with 10 μ F capacitor to the AGND pin or plane. This output is available externally for dc coupling and level-shifting. CMOUT should not have any signal dependent load, or used where it will sink or source current.
OUTL	8	O	Left channel line level analog output.
OUTR	13	O	Right channel line level analog output.

Power Supply Connections and Miscellaneous

Pin Name	Number	I/O	Description
AV _{DD}	7, 14	I	Analog Power Supply. Connect to analog +5 V supply.
AGND	9, 12	I	Analog Ground.
DV _{DD}	17	I	Digital Power Supply. Connect to digital +5 V supply.
DGND	16	I	Digital Ground.
N/C	4		No Connect. Reserved. Do not connect.

AD1857/AD1858

DEFINITIONS

Dynamic Range

The ratio of a full-scale output signal to the integrated output noise in the passband (0 kHz to 20 kHz), expressed in decibels (dB). Dynamic range is measured with a -60 dB input signal and is equal to $(S/[THD+N]) + 60$ dB. Note that spurious harmonics are below the noise with a -60 dB input, so the noise level establishes the dynamic range. This measurement technique is consistent with the recommendations of the Audio Engineering Society (AES17-1991) and the Electronic Industries Association of Japan (EIAJ CP-307).

Total Harmonic Distortion + Noise (THD+N)

The ratio of the root-mean-square (rms) value of a full-scale fundamental input signal to the rms sum of all other spectral components in the passband, expressed in decibels (dB) and as a percentage.

Passband

The region of the frequency spectrum unaffected by the attenuation of the digital interpolation filter.

Passband Ripple

The peak-to-peak variation in amplitude response from equal-amplitude input signal frequencies within the passband, expressed in decibels.

Stopband

The region of the frequency spectrum attenuated by the digital interpolation filter to the degree specified by "stopband attenuation."

Gain Error

With a near full-scale input, the ratio of actual output to expected output, expressed as a percentage.

Interchannel Gain Mismatch

With identical near full-scale inputs, the ratio of outputs of the two stereo channels, expressed in decibels.

Gain Drift

Change in response to a near full-scale input with a change in temperature, expressed as parts-per-million (ppm) per °C.

Crosstalk (EIAJ Method)

Ratio of response on one channel with a zero input, to a full-scale 1 kHz sine-wave input on the other channel, expressed in decibels.

Interchannel Phase Deviation

Difference in output sampling times between stereo channels, expressed as a phase difference in degrees between 1 kHz inputs.

Power Supply Rejection

With zero input, signal present at the output when a 300 mV p-p signal is applied to power supply pins, expressed in decibels of full scale.

Group Delay

Intuitively, the time interval required for an input pulse to appear at the converter's output, expressed in seconds(s). More precisely, the derivative of radian phase with respect to radian frequency at a given frequency.

Group Delay Variation

The difference in group delays at different input frequencies. Specified as the difference between the largest and the smallest group delays in passband, expressed in microseconds (μ s).

De-Emphasis Gain Error

A measure, expressed in decibels, of the difference between the ideal 50/15 μ s de-emphasis filter response, and the actual 50/15 μ s de-emphasis filter response.

Typical Performance Characteristics

Figures 1 through 4 illustrate the typical performance of the AD1857/AD1858 as measured by an Audio Precision System Two. Signal-to-Noise (dynamic range) THD+N performance is shown under a range of conditions. Figure 5 shows the power

supply rejection performance of the AD1857/AD1858. The channel separation performance of the AD1857/AD1858 is shown in Figure 6. The digital filter transfer function is shown in Figure 7.

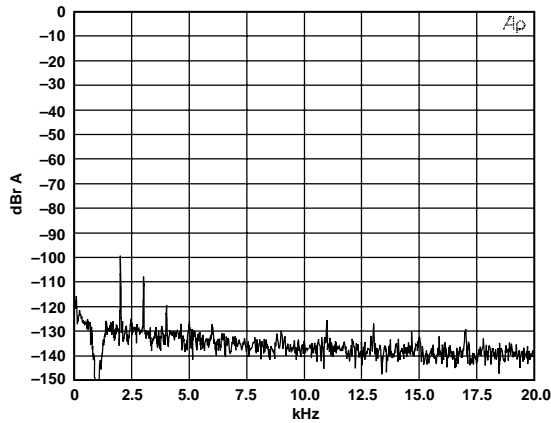

Figure 1. 1 kHz Tone at -0.5 dBFS

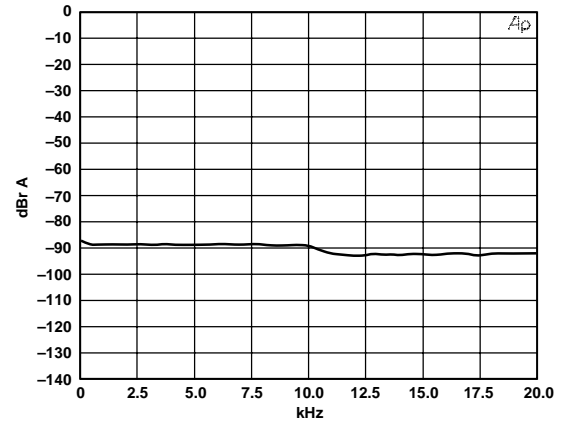

Figure 3. THD+N vs. Frequency at -0.5 dBFS

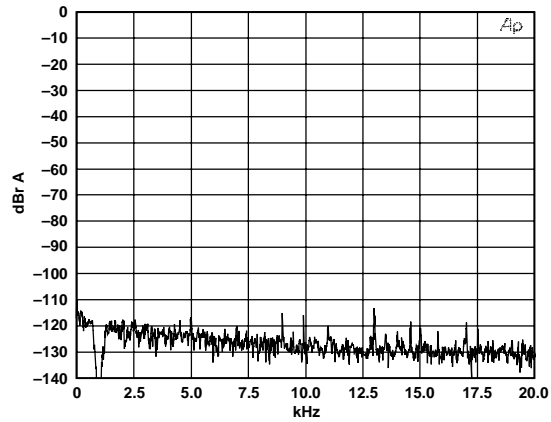

Figure 2. 1 kHz Tone at -10 dBFS

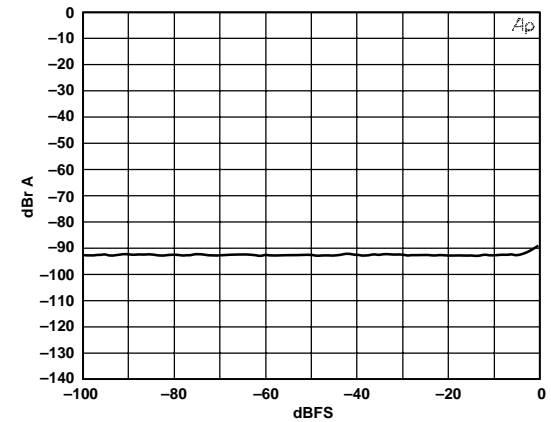

Figure 4. THD+N vs. Amplitude at 1 kHz

AD1857/AD1858

Typical Performance Characteristics (continued)

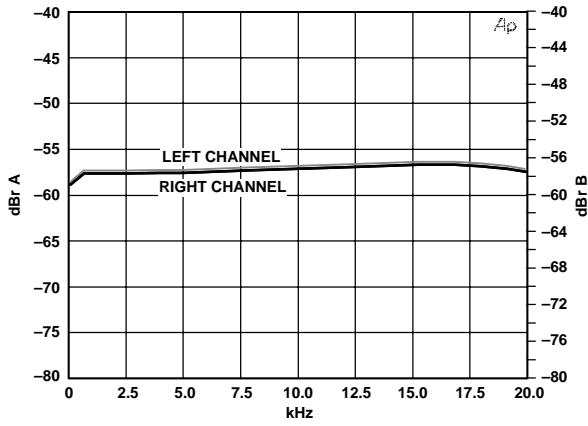

Figure 5. Power Supply Rejection to 300 mV p-p on AV_{DD}

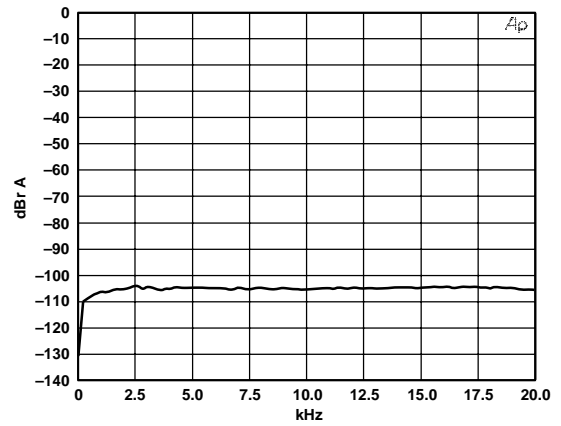

Figure 6. Channel Separation vs. Frequency at -0.5 dBFS

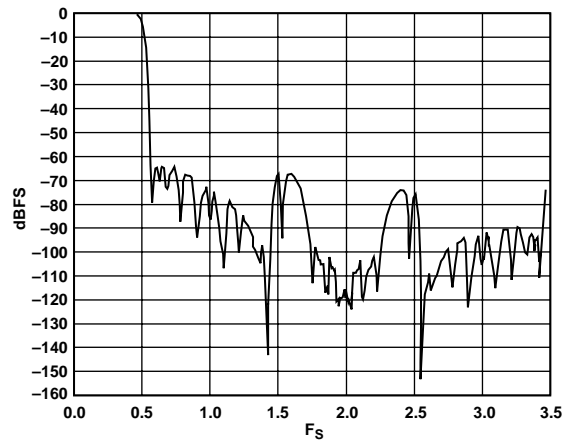

Figure 7. Digital Filter Signal Transfer Function to $3.5 \times F_s$

THEORY OF OPERATION

The AD1857/AD1858 offer the advantages of sigma-delta conversion architectures (no component trims, low cost CMOS process technology, superb low-level linearity performance) with the advantages of conventional multibit R-2R resistive ladder audio DACs (continuously variable sample rate support, jitter tolerance, very low output noise, etc.).

The use of a multibit sigma-delta modulator means that the AD1857/AD1858 generate dramatically lower amounts of out-of-band noise energy, which greatly reduces the requirement on post DAC filtering. The required post-filtering is integrated on the AD1857/AD1858. The AD1857/AD1858's multibit sigma-delta modulator is also highly immune to digital substrate noise.

Serial Audio Data Interface

The serial audio data interface uses the bit clock (BCLK) simply to clock the data into the AD1857/AD1858. The bit clock may therefore be asynchronous to the L/\bar{R} clock. The left/right clock ($L\bar{R}CLK$) is both a framing signal and the sample frequency input to the interpolation filter. The left/right clock must be synchronous with MCLK, but may have any phase relationship with respect to MCLK; $L\bar{R}CLK$ is generally synchronously divided down from MCLK. The SDATA input carries the serial stereo digital audio in MSB first, twos-complement format.

Digital Interpolation Filter

The purpose of the interpolator is to "oversample" the input data, i.e., to increase the sample rate so the first signal image is moved out to the oversample frequency, which relaxes the attenuation requirements on the analog reconstruction filter. The AD1857/AD1858 interpolator increases the input data sample rate by 128. The interpolation is performed using a multistage FIR digital filter structure. The first stage is a droop equalizer; the second and third stages are halfband filters; and the fourth stage is a second-order comb filter. The FIR filter implementation is multiplier-free, i.e., the multiplies are performed using shift-and-add operations. The FIR filter coefficients have been recoded in a canonical sign digit format to enable the use of a compact arithmetic logic unit without a multiplier.

Multibit Sigma-Delta Modulator

The AD1857/AD1858 employ a 4-bit second-order sigma-delta modulator. Whereas a traditional single-bit sigma-delta modulator has two levels of quantization, the AD1857/AD1858's has 17 levels of quantization. Traditional single-bit sigma-delta modulators sample the input signal at 64 times the input sample rate; the AD1857/AD1858 sample the input signal at 128 times the input sample rate. The additional quantization levels combined with the high oversampling ratio means that the AD1857/AD1858 DAC output spectrum contains dramatically lower levels of out-of-band noise energy, which is a major stumbling block with more traditional single-bit sigma-delta architectures. This means that the post-DAC analog reconstruction filter has reduced transition band steepness and attenuation requirements, which directly equates to lower phase distortion. Since the analog filtering generally establishes the noise and distortion characteristic of the DAC, the reduced requirements translate into better audio performance.

Multibit sigma-delta modulators bring an additional benefit: they are essentially free of stability (and therefore potential loop oscillation) problems. They are able to scale the output signal to a wider range of the voltage reference, which can increase the overall dynamic range of the converter.

The conventional problem limiting the performance of multibit sigma-delta converters is the nonlinearity of the passive circuit elements used to sum the quantization levels. Analog Devices has developed (and received patents on) a revolutionary architecture that overcomes the circuit element linearity problem that otherwise limits the performance of multibit sigma-delta audio converters. This new architecture provides the AD1857/AD1858 with the same excellent differential nonlinearity and linearity drift (over temperature and time) specifications as single bit sigma-delta DACs.

The AD1857/AD1858's multibit modulator has another important advantage; it has a high immunity to substrate digital noise. Substrate noise can be a significant problem in mixed-signal designs, where it can produce intermodulation products that fold down into the audio band. The AD1857/AD1858 are approximately eight times less sensitive to digital substrate noise (voltage reference noise injection) than equivalent single-bit sigma-delta modulator based DACs.

Dither Generator

The AD1857/AD1858 include an on-chip dither generator that is intended to further "whiten" the quantization noise introduced by the multibit DAC. The dither has a triangular Probability Distribution Function (PDF) characteristic, which is generally considered to create the most favorable noise shaping of the residual quantization noise. The AD1857/AD1858 are among the first low cost IC audio DACs to include dithering.

Analog Filtering

The AD1857/AD1858 include a second-order switched capacitor discrete time low-pass filter followed by a first-order analog continuous time low-pass filter. These filters eliminate the need for any additional off-chip external reconstruction filtering. This on-chip switched capacitor analog filtering is essential to reduce the deleterious effects of master clock jitter.

Digital De-Emphasis Processing

The AD1857/AD1858 include digital circuitry for implementing the 50/15 μ s de-emphasis frequency response characteristic. A control pin DEEMP (Pin 5) enables de-emphasis when it is asserted HI. The digital de-emphasis response assumes a sample frequency of 44.1 kHz. The transfer function magnitude error of this digital filter is less than ± 0.1 dB (from 0 kHz to 20 kHz) compared to a 50/15 μ s continuous time filter. If the sample frequency is not 44.1 kHz, the de-emphasis frequency response will scale directly with frequency. The 44.1 kHz F_S digital de-emphasis frequency response is shown in Figure 8.

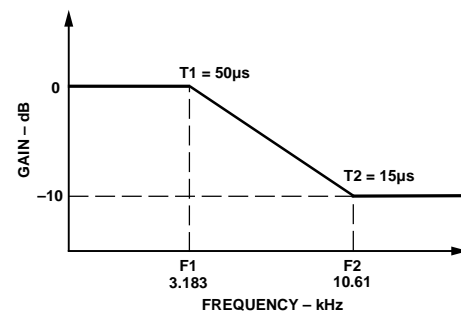

Figure 8. Digital De-Emphasis Frequency Response

AD1857/AD1858

OPERATING FEATURES

Serial Data Input Port

The AD1857/AD1858 use the frequency of the left/right and master input clocks to determine the input sample rate. Generally, the master clock (MCLK) is divided down to synthesize the left/right clock (LRCLK). LRCLK must run continuously and transition twice per stereo sample period (except in the left-justified DSP serial port style mode, when it transitions four times per stereo sample period). The bit clock (BCLK) is edge-sensitive and may be used in a gated or burst mode, i.e., a stream of pulses during data transmission followed by periods of inactivity. The bit clock is only used to write the audio data into the serial input port. It is important that the left/right clock is “clean,” with monotonic rising and falling edge transitions and no excessive overshoot or undershoot that could cause false clock triggering of the AD1857/AD1858.

The AD1857/AD1858’s flexible serial data input port accepts data in twos-complement, MSB first format. The left channel data field always precedes the right channel data field. The input data consists of 16, 18 or 20 bits (16 bits only to the AD1858). All digital inputs are specified to TTL logic levels. The input data port is configured by a control pin, MODE, Pin 3. The AD1857 and the AD1858 are identical except for the serial data input port modes offered. The AD1857 offers I²S-justified and left-justified modes, for 16-, 18- or 20-bit data words. The AD1858 offers right-justified and DSP serial port style mode for 16-bit data words.

Note: During the first 30,000 MCLK cycles after coming out of reset, the AD1857/AD1858 synchronizes its internal sequencer counter to the incoming LRCLK. After this period of time, it is assumed that the LRCLK and the internal AD1857/AD1858 output channels could be switched (L to R and R to L). Therefore, if the incoming LRCLK is stopped and then restarted with a different phase, the AD1857/AD1858 should be reset again to synchronize with this new clock.

Serial Input Port Modes

The AD1857/AD1858 use an input pin to control the mode configuration of the input data port. MODE (Pin 3) programs the input data port mode as follows:

Figure 9 shows the AD1857 left-justified mode. LRCLK is HI for the left channel, and LO for the right channel. Data is valid on the rising edge of BCLK. The MSB is left-justified to an LRCLK transition, with no MSB delay. The left-justified mode can be used in the 16-, 18- or 20-bit input mode.

MODE (Pin 3)	AD1857 Serial Input Port Mode
LO	Left-Justified (See Figure 9)
HI	I ² S-Justified (See Figure 10)

MODE (Pin 3)	AD1858 Serial Input Port Mode
LO	Right-Justified (See Figure 11)
HI	Left-Justified DSP Serial Port Style (See Figure 12)

Figure 10 shows the AD1857 I²S-justified mode. LRCLK is LO for the left channel, and HI for the right channel. Data is valid on the rising edge of BCLK. The MSB is left-justified to an LRCLK transition, but with a single BCLK period delay. The I²S-justified mode can be used in the 16-, 18- or 20-bit input mode.

Figure 11 shows the AD1858 the right-justified mode. LRCLK is HI for the left channel, and LO for the right channel. Data is valid on the rising edge of BCLK. The MSB is delayed 16-bit clock periods from an LRCLK transition so that when there are 64 BCLK periods per LRCLK period, the LSB of the data will be right-justified to the next LRCLK transition.

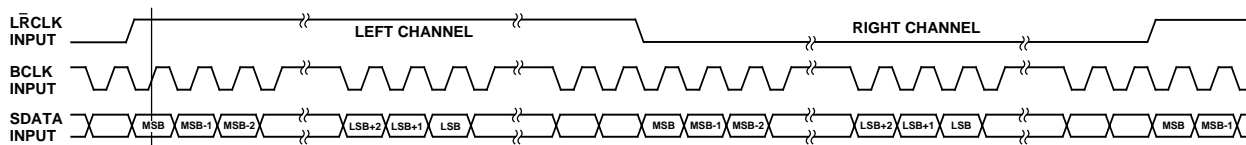

Figure 9. AD1857 Left-Justified Mode

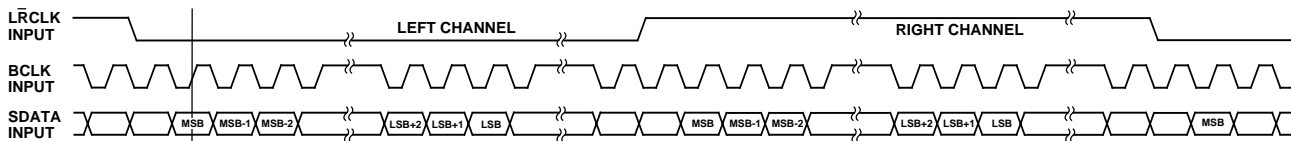

Figure 10. AD1857 I²S-Justified Mode

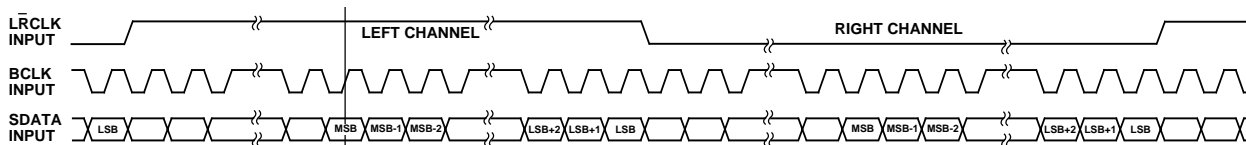

Figure 11. AD1858 Right-Justified Mode

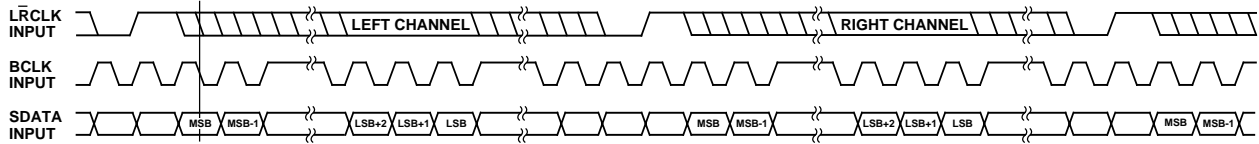

Figure 12. AD1858 Left-Justified DSP Serial Port Style

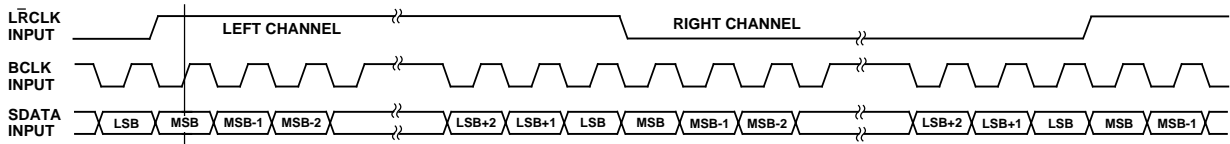

Figure 13. AD1857/AD1858 $32 \times F_S$ Packed Mode

Figure 12 shows the AD1858 left-justified DSP serial port style mode. $\overline{\text{LRCLK}}$ must pulse HI for at least one bit clock period before the MSB of the left channel is valid, and $\overline{\text{LRCLK}}$ must pulse HI again for at least one bit clock period before the MSB of the right channel is valid. Data is valid on the falling edge of BCLK. Note that in this mode, it is the responsibility of the DSP to ensure that the left data is transmitted with the first $\overline{\text{LRCLK}}$ pulse, the right data is transmitted with the second $\overline{\text{LRCLK}}$ pulse, and synchronism is maintained from that point forward.

Note that in 16-bit input mode, the AD1857/AD1858 are capable of a $32 \times F_S$ BCLK frequency “packed mode” where the MSB is left-justified to an $\overline{\text{LRCLK}}$ transition, and the LSB is right-justified to an $\overline{\text{LRCLK}}$ transition. $\overline{\text{LRCLK}}$ is HI for the left channel, and LO for the right channel. Data is valid on the rising edge of BCLK. Packed mode can be used when the AD1857 is programmed in left-justified mode, or when the AD1858 is programmed in right-justified mode. Packed mode is shown in Figure 13.

Master Clock

The synchronous master clock of the AD1857/AD1858 is supplied by an external clock source applied to MCLK. Figure 14 shows example connections. Do not change the state of the 384/256 pin while the AD1857/AD1858 is operational; this pin should be hardwired LO or HI. Alternatively, its state may be changed while the $\overline{\text{PD/RST}}$ pin is asserted LO.

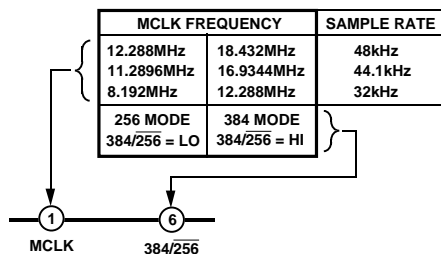

Figure 14. AD1857/AD1858 Clock Connections

Digital Mute

The AD1857/AD1858 offer a control pin that mutes the analog output. By asserting the MUTE (Pin 15) signal HI, both the left channel and the right channel are muted. The AD1857/AD1858 have been designed to minimize pops and clicks when muting and unmuting the device. The AD1857/AD1858 include a zero crossing detector which attempts to implement mute on waveform zero crossings only. If a zero crossing is not

found within 1024 input sample periods (approximately 23 milliseconds at 44.1 kHz), the output is muted regardless.

Output Drive, Buffering and Loading

The AD1857/AD1858 analog output stage is able to drive a 2 k Ω load. If lower impedance loads must be driven, an external buffer stage such as the Analog Devices SSM2142 should be used. The analog output is generally ac coupled with a 10 μF capacitor as shown in Figure 21. It is possible to dc couple the AD1857/AD1858 output into an op amp stage using the CMOUT signal as a bias point.

On-Chip Voltage Reference

The AD1857/AD1858 include an on-chip voltage reference that establishes the output voltage range. The nominal value of this reference is +2.25 V, which corresponds to a line output voltage swing of 3 V p-p. The line output signal is centered around a voltage established by the CMOUT (common-mode output) (Pin 10). The reference must be bypassed both on the FILT input (Pin 11) with 10 μF and 0.1 μF capacitors, and on the CMOUT output (Pin 10) with 10 μF and 0.1 μF capacitors, as shown in Figure 21. Both the FILT pin and the CMOUT pin use the AGND ground. The on-chip voltage reference may be overdriven with an external reference source by applying this voltage to the FILT pin. CMOUT and FILT must still be bypassed as shown in Figure 21. An external reference can be useful to calibrate multiple AD1857/AD1858 DACs to the same gain. Reference bypass capacitors larger than those suggested can be used to improve the signal-to-noise performance of the AD1857/AD1858.

Power-Down and Reset

The $\overline{\text{PD/RST}}$ input (Pin 2) is used to control the power consumed by the AD1857/AD1858. When $\overline{\text{PD/RST}}$ is held LO, the AD1857/AD1858 are placed in a low dissipation power-down state. When $\overline{\text{PD/RST}}$ is brought HI, the AD1857/AD1858 become ready for normal operation. The master clock (MCLK, Pin 1) must be running for a successful reset or power-down operation to occur. The $\overline{\text{PD/RST}}$ signal must be LO for a minimum of four master clock periods (326 ns with a 12.288 MHz MCLK frequency).

When the $\overline{\text{PD/RST}}$ input (Pin 2) is brought HI, the AD1857/AD1858 are reset. All registers in the AD1857/AD1858 digital engine (serial data port, interpolation filter and modulator) are zeroed, and the amplifiers in the analog section are shorted during the reset operation. The AD1857/AD1858 have been designed to minimize pops and clicks when entering and exiting the power-down state.

AD1857/AD1858

Control Signals

The MODE and DEEMP control inputs are normally connected HI or LO to establish the operating state of the AD1857/AD1858. They can be changed dynamically (and asynchronously to the LRCLK and the master clock) as long as they are stable before the first serial data input bit (i.e., the MSB) is presented to the AD1857/AD1858.

APPLICATION ISSUES

Interface to MPEG Audio Decoders

Figure 15 shows the suggested interface to the Analog Devices ADSP-21xx family of DSP chips, for which several MPEG audio decode algorithms are available. The ADSP-21xx supports 16 bits of data using a left-justified DSP serial port style format.

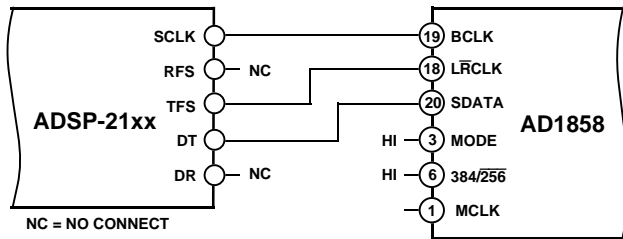

Figure 15. Interface to ADSP-21xx

Figure 16 shows the suggested interface to the Texas Instruments TMS320AV110* MPEG audio decoder IC. The TMS320AV110 supports 18 bits of data using a right-justified output format.

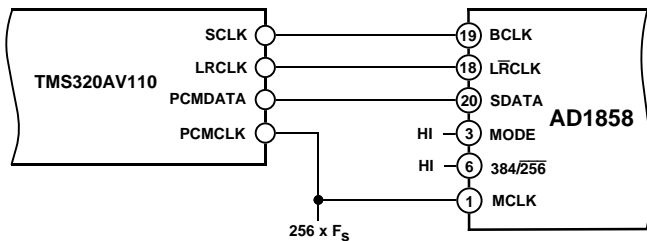

Figure 16. Interface to TMS320AV110

Figure 17 shows the suggested interface to the LSI Logic L64111* MPEG audio decoder IC. The L64111 supports 16 bits of data using a left-justified output format.

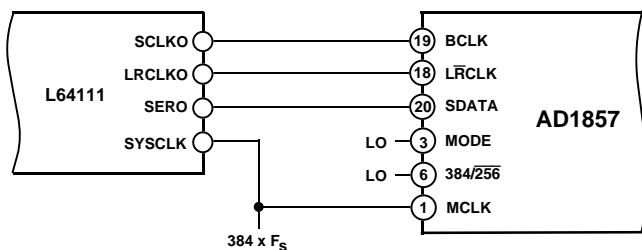

Figure 17. Interface to L64111

Figure 18 shows the suggested interface to the Philips SAA2500* MPEG audio decoder IC. The SAA2500 supports 18 bits of data using an I²S-compatible output format.

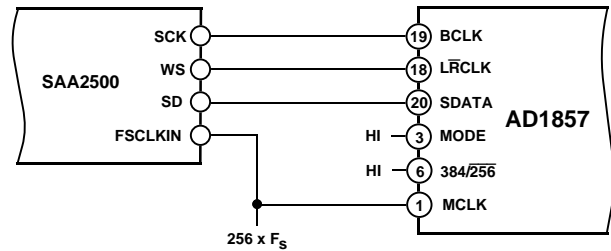

Figure 18. Interface to SAA2500

Figure 19 shows the suggested interface to the Zoran ZR38000* DSP chip, which can act as an MPEG audio or AC-3 audio decoder. The ZR38000 supports 16 bits of data using a left-justified output format.

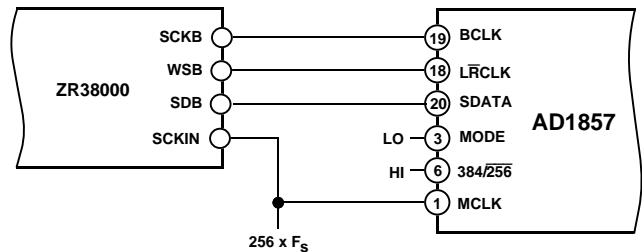

Figure 19. Interface to ZR38000

Figure 20 shows the suggested interface to the C-Cube Microsystems CL480* MPEG system decoder IC. The CL480 supports 16 bits of data using a right-justified output format.

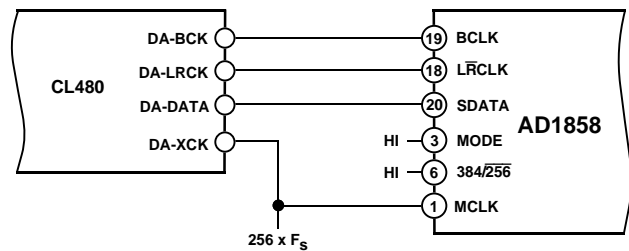

Figure 20. Interface to CL480

*All trademarks are properties of their respective holders.

Layout and Decoupling Considerations

The recommended decoupling, bypass and output circuits for the AD1857/AD1858 are shown in Figure 21.

PCB and Ground Plane Recommendations

The AD1857/AD1858 ideally should be located above a split ground plane, with the digital pins over the digital ground plane and the analog pins over the analog ground plane. The split should occur between Pins 6 and 7, and between Pins 14 and 15 as shown in Figure 22. The ground planes should be linked with a ferrite bead. This ground plane strategy maximizes the AD1857/AD1858's analog audio performance.

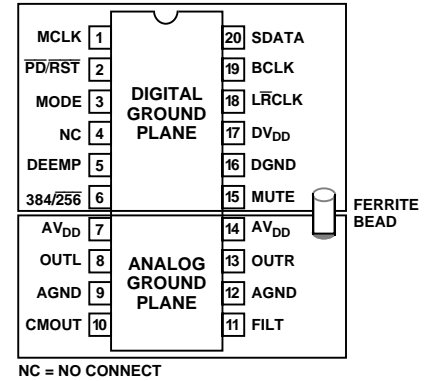

Figure 22. Recommended Ground Plane

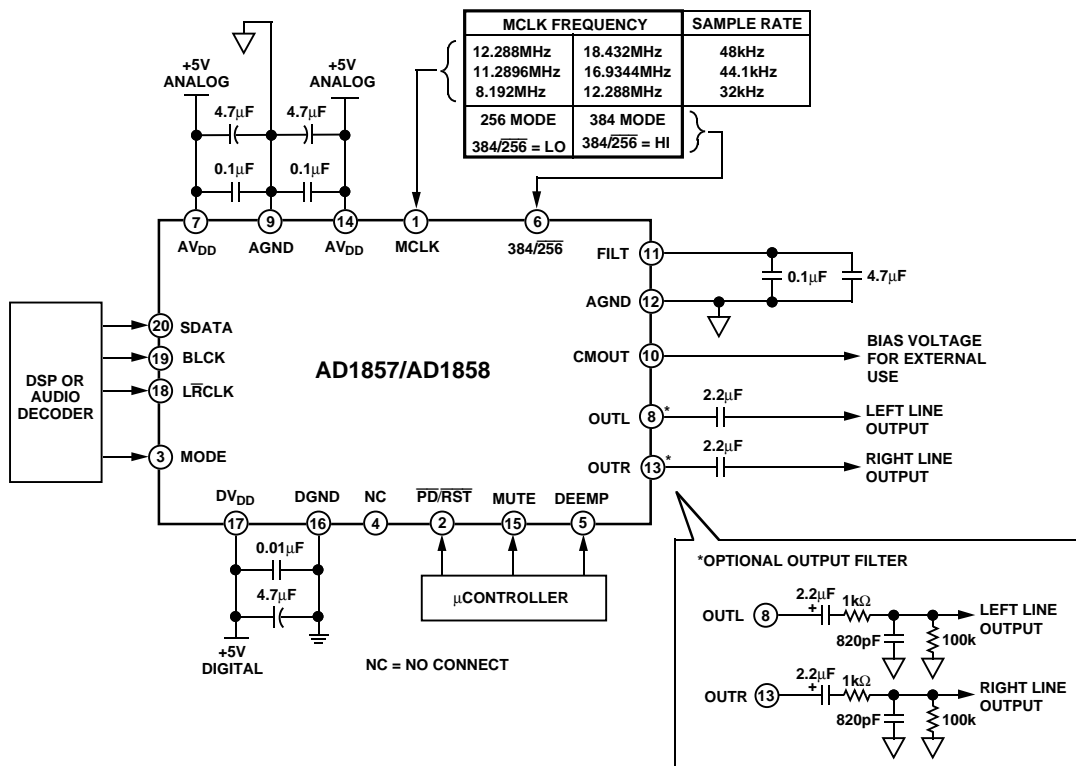

Figure 21. Recommended Circuit Connection

AD1857/AD1858

Timing Diagrams

The serial data port timing is shown in Figures 23 and 24. The minimum bit clock HI pulse width is t_{DBH} and the minimum bit clock LO pulse width is t_{DBL} . The minimum bit clock period is t_{DBP} . The left/right clock minimum setup time is t_{DLS} and the left/right clock minimum hold time is t_{DLH} . The serial data

minimum setup time is t_{DDS} and the minimum serial data hold time is t_{DDH} .

The power-down/reset timing is shown in Figure 25. The minimum reset LO pulse width is t_{PDRP} (four MCLK periods) to accomplish a successful AD1857/AD1858 reset operation.

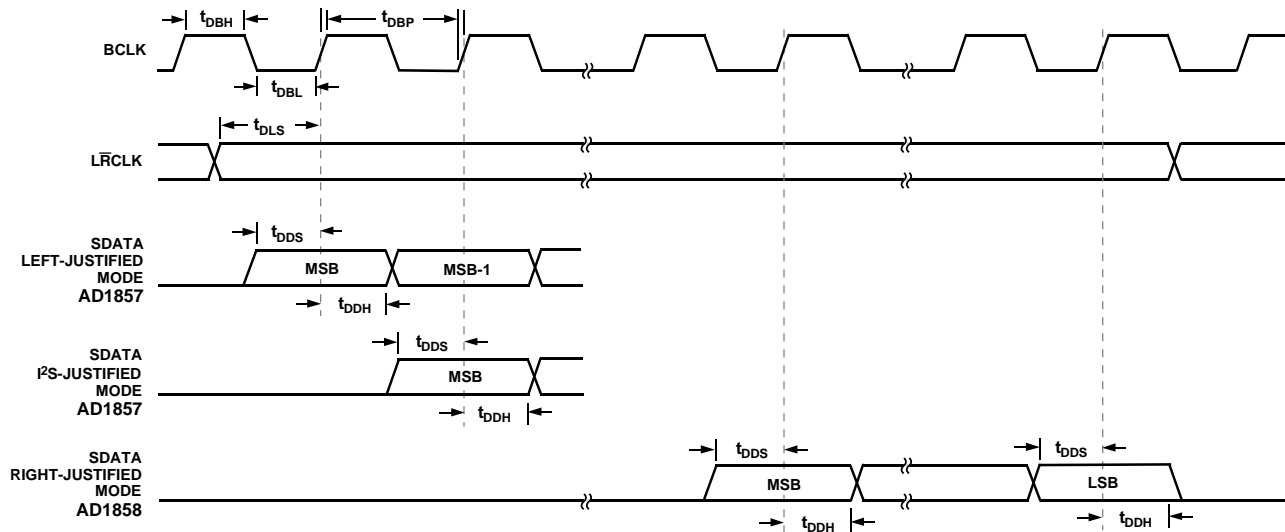

Figure 23. Serial Data Port Timing

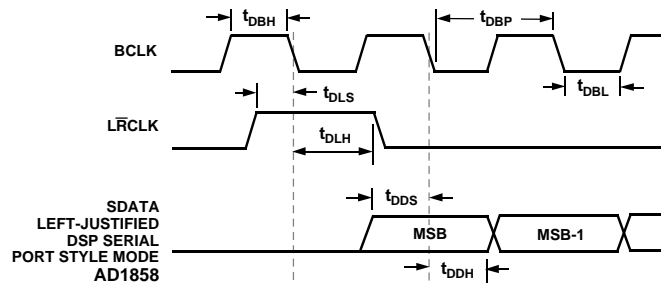

Figure 24. Serial Data Port Timing—DSP Serial Port Style Mode (AD1858 Only)

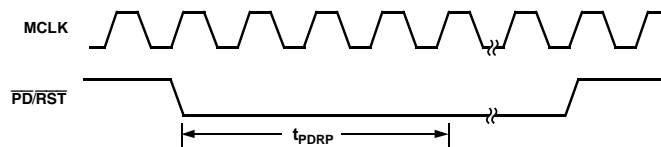
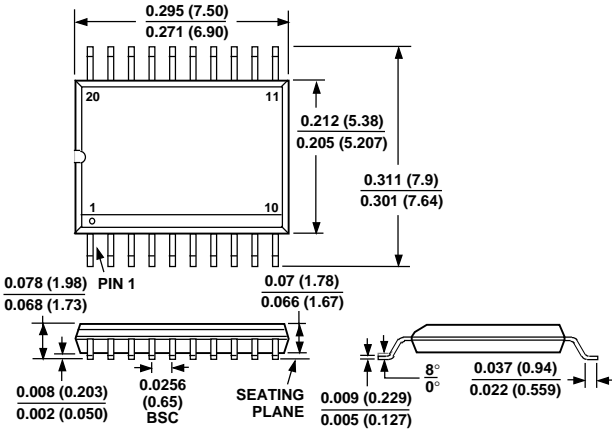

Figure 25. Power-Down/Reset Timing

OUTLINE DIMENSIONS

Dimensions shown in inches and (mm).

**20-Lead SSOP
(RS-20)**



1. LEAD NO. 1 IDENTIFIED BY A DOT.
2. LEADS WILL BE EITHER TIN PLATED OR SOLDER DIPPED IN ACCORDANCE WITH MIL-M-38510 REQUIREMENTS

