



# ±15kV ESD-Protected, EMC-Compliant, 230kbps, Dual RS-232 Serial Port for Motherboards/Desktops

MAX3187

## General Description

The MAX3187 complete, dual DTE RS-232 serial port meets the stringent ESD requirements of the European Community. All transmitter outputs and receiver inputs are protected to ±15kV using IEC 1000-4-2 Air-Gap Discharge, ±8kV using IEC 1000-4-2 Contact Discharge, and ±15kV using the Human Body Model.

The MAX3187's six RS-232 transmitters and ten RS-232 receivers require no charge pump. Guaranteed to run at data rates up to 230kbps, the MAX3187 is optimized for desktop PC and motherboard applications, and is compatible with popular software for PC communications. Power-supply current is less than 1mA for I<sub>DD</sub> and I<sub>SS</sub>, and less than 3mA for I<sub>CC</sub>.

The MAX3187 is available in a space-saving 36-pin SSOP package.

## Applications

- Desktop PC
- Motherboards
- Instruments
- Equipment Meeting IEC 1000-4-2

## Features

- ◆ **Enhanced ESD Protection:**
  - ±15kV—Human Body Model
  - ±8kV—IEC 1000-4-2, Contact Discharge
  - ±15kV—IEC 1000-4-2, Air-Gap Discharge
- ◆ **Latchup Free During an ESD Event**
- ◆ **36-Pin SSOP Package**
- ◆ **Guaranteed 230kbps Data Rate**
- ◆ **Flow-Through Pinout**
- ◆ **Two Complete DTE Serial Ports**
- ◆ **6 RS-232 Drivers and 10 RS-232 Receivers**

## Ordering Information

PART	TEMP. RANGE	PIN-PACKAGE
MAX3187CAX	0°C to +70°C	36 SSOP
MAX3187EAX	-40°C to +85°C	36 SSOP

Typical Operating Circuit appears at end of data sheet.

## Pin Configuration

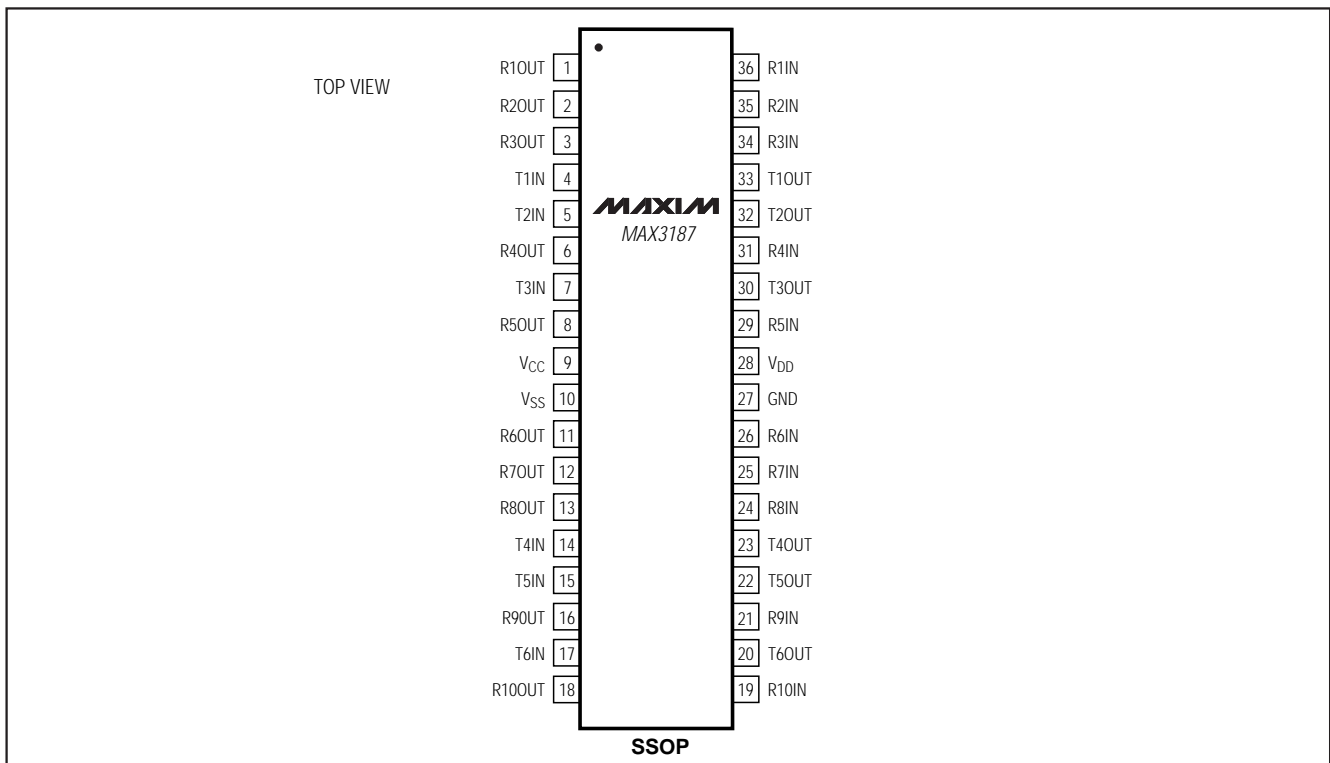

# ±15kV ESD-Protected, EMC-Compliant, 230kbps, Dual RS-232 Serial Port for Motherboards/Desktops

## ABSOLUTE MAXIMUM RATINGS

V <sub>CC</sub> .....	-0.3V to +7V	Short-Circuit Duration	
V <sub>DD</sub> .....	-0.3V to +14V	T_OUT (one at a time) .....	Continuous
V <sub>SS</sub> .....	+0.3V to -14V	R_OUT (one at a time) .....	Continuous
Input Voltages		Continuous Power Dissipation (T <sub>A</sub> = +70°C)	
T_IN .....	-0.3V to +6V	SSOP (derate 11.76mW/°C above +70°C) .....	762mW
R_IN .....	±30V	Operating Temperature Ranges	
Output Voltages		MAX3187CAX .....	0°C to +70°C
T_OUT .....	±15V	MAX3187EAX .....	-40°C to +85°C
R_OUT .....	-0.3V to (V <sub>CC</sub> + 0.3V)	Storage Temperature Range .....	-65°C to +160°C
		Lead Temperature (soldering, 10sec) .....	+300°C

Stresses beyond those listed under "Absolute Maximum Ratings" may cause permanent damage to the device. These are stress ratings only, and functional operation of the device at these or any other conditions beyond those indicated in the operational sections of the specifications is not implied. Exposure to absolute maximum rating conditions for extended periods may affect device reliability.

## ELECTRICAL CHARACTERISTICS

(V<sub>CC</sub> = +4.5V to +5.5V, V<sub>DD</sub> = +10.8V to +13.2V, V<sub>SS</sub> = -10.8V to -13.2V, T<sub>A</sub> = T<sub>MIN</sub> to T<sub>MAX</sub>, unless otherwise noted. Typical values are at T<sub>A</sub> = +25°C.)

PARAMETER	SYMBOL	CONDITIONS	MIN	TYP	MAX	UNITS
<b>DC CHARACTERISTICS</b>						
Operating Voltage Range	V <sub>CC</sub>		4.5		5.5	V
	V <sub>DD</sub>		10.8		13.2	
	V <sub>SS</sub>		-13.2		-10.8	
Supply Current	I <sub>CC</sub>	No load		750	3000	μA
	I <sub>DD</sub>	No load		370	1000	
	I <sub>SS</sub>	No load		370	1000	
<b>LOGIC</b>						
Input Logic Threshold Low	V <sub>ILT</sub>	T_IN			0.8	V
Input Logic Threshold High	V <sub>IHT</sub>	T_IN	2.0			V
Input Leakage Current				0.01	1	μA
Output Voltage Low	V <sub>OLR</sub>	R_OUT; I <sub>SINK</sub> = 3.2mA			0.4	V
Output Voltage High	V <sub>OHR</sub>	R_OUT; I <sub>SOURCE</sub> = 1mA	V <sub>CC</sub> - 0.6			V
<b>TRANSMITTER OUTPUTS</b>						
Output Voltage Swing		V <sub>DD</sub> = 7.0V, V <sub>SS</sub> = -7.0V, R <sub>L</sub> = 3kΩ	±5.0			V
		V <sub>DD</sub> = 12V, V <sub>SS</sub> = -12V, R <sub>L</sub> = 3kΩ	±9.5			
Transmitter Output Resistance		V <sub>CC</sub> = V <sub>DD</sub> = V <sub>SS</sub> = 0, V <sub>T_OUT</sub> = ±2V	300			Ω
RS-232 Output Short-Circuit Current				±35	±60	mA
<b>RECEIVER INPUTS</b>						
Receiver Input Voltage Range			-25		25	V
RS-232 Input Threshold Low			0.75			V
RS-232 Input Threshold High					2.4	V
RS-232 Input Hysteresis				0.65		V
RS-232 Input Resistance			3	5	7	kΩ
Receiver Output Short-Circuit Current				±10		mA

# ±15kV ESD-Protected, EMC-Compliant, 230kbps, Dual RS-232 Serial Port for Motherboards/Desktops

MAX3187

## ELECTRICAL CHARACTERISTICS (continued)

(V<sub>CC</sub> = +4.5V to +5.5V, V<sub>DD</sub> = +10.8V to +13.2V, V<sub>SS</sub> = -10.8V to -13.2V, T<sub>A</sub> = T<sub>MIN</sub> to T<sub>MAX</sub>, unless otherwise noted. Typical values are at T<sub>A</sub> = +25°C.)

PARAMETER	SYMBOL	CONDITIONS	MIN	TYP	MAX	UNITS
<b>ESD CHARACTERISTICS</b>						
ESD Protection		Human Body Model	±15		kV	
		IEC 1000-4-2 (Contact Discharge)	±8			
		IEC 1000-4-2 (Air-Gap Discharge)	±15			
<b>TIMING CHARACTERISTICS</b>						
Transmitter Output Propagation Delay, Low to High	t <sub>PLHT</sub>	V <sub>DD</sub> = 12V, V <sub>SS</sub> = -12V, R <sub>L</sub> = 3kΩ, C <sub>L</sub> = 1000pF, T <sub>A</sub> = +25°C			4	μs
Transmitter Output Propagation Delay, High to Low	t <sub>PHLT</sub>	V <sub>DD</sub> = 12V, V <sub>SS</sub> = -12V, R <sub>L</sub> = 3kΩ, C <sub>L</sub> = 1000pF, T <sub>A</sub> = +25°C			4	μs
Transmitter Propagation Delay Skew,  t <sub>PLHT</sub> - t <sub>PHLT</sub>	t <sub>SKT</sub>	V <sub>DD</sub> = 12V, V <sub>SS</sub> = -12V, R <sub>L</sub> = 3kΩ, C <sub>L</sub> = 1000pF, T <sub>A</sub> = +25°C			0.4	μs
Transition Output Slew Rate	SR	V <sub>DD</sub> = 12V, V <sub>SS</sub> = -12V, R <sub>L</sub> = 3kΩ to 7kΩ, measured from +3V to -3V or -3V to +3V, Figure 1, T <sub>A</sub> = +25°C	C <sub>L</sub> = 150pF to 2500pF	4	30	V/μs
			C <sub>L</sub> = 50pF to 1000pF	8	30	
Receiver Output Propagation Delay, Low to High	t <sub>PLHR</sub>	V <sub>CC</sub> = 5V, C <sub>L</sub> = 50pF, T <sub>A</sub> = +25°C			4.0	μs
Receiver Output Propagation Delay, High to Low	t <sub>PHLR</sub>	V <sub>CC</sub> = 5V, C <sub>L</sub> = 50pF, T <sub>A</sub> = +25°C			4.0	μs
Receiver Propagation Delay Skew,  t <sub>PLHR</sub> - t <sub>PHLR</sub>	t <sub>SKR</sub>	V <sub>CC</sub> = 5V, C <sub>L</sub> = 50pF, T <sub>A</sub> = +25°C			0.4	μs
Guaranteed Data Rate	DR	V <sub>CC</sub> = 5V, V <sub>DD</sub> = 12V, V <sub>SS</sub> = -12V, R <sub>L</sub> = 3kΩ to 7kΩ, T <sub>A</sub> = +25°C, any two transmitters switching	C <sub>L</sub> = 50pF to 2500pF	120		kbps
			C <sub>L</sub> = 50pF to 1000pF	230		
Mouse Driveability		T3OUT = -5mA, T1OUT = T2OUT = 5mA	±7.5			V

# $\pm 15\text{kV}$ ESD-Protected, EMC-Compliant, 230kbps, Dual RS-232 Serial Port for Motherboards/Desktops

## Typical Operating Characteristics

( $V_{CC} = +5\text{V}$ ,  $V_{DD} = +12\text{V}$ ,  $V_{SS} = -12\text{V}$ ,  $T_A = +25^\circ\text{C}$ , unless otherwise noted.)

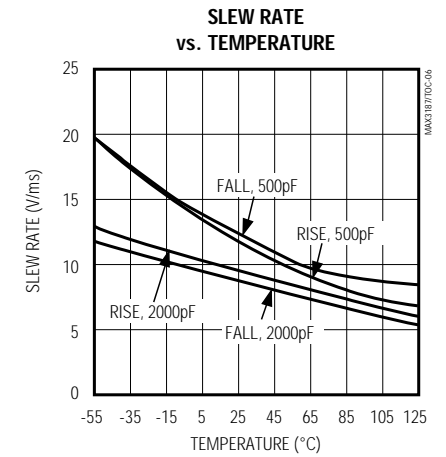
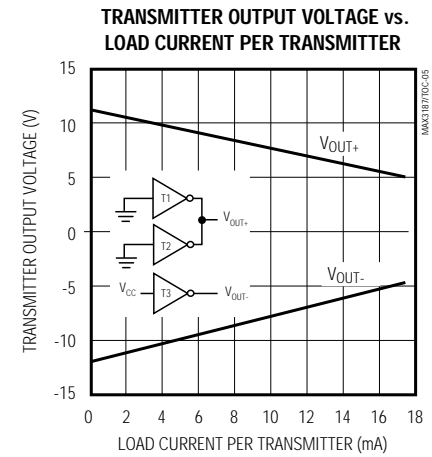
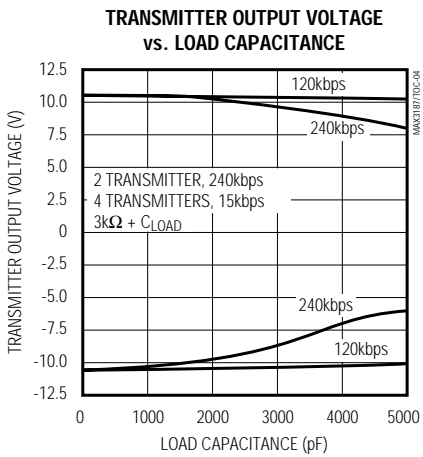
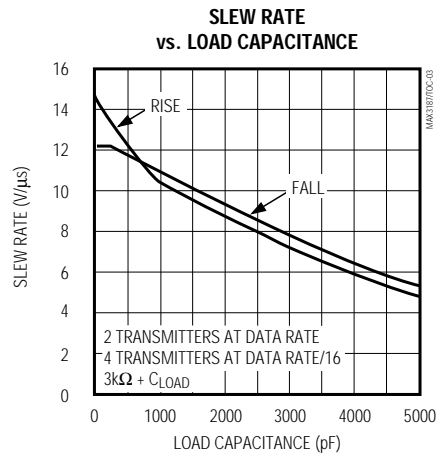
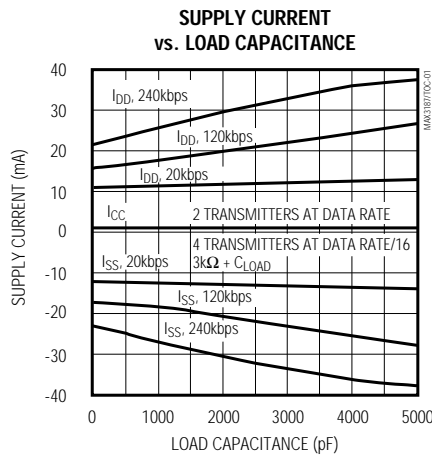
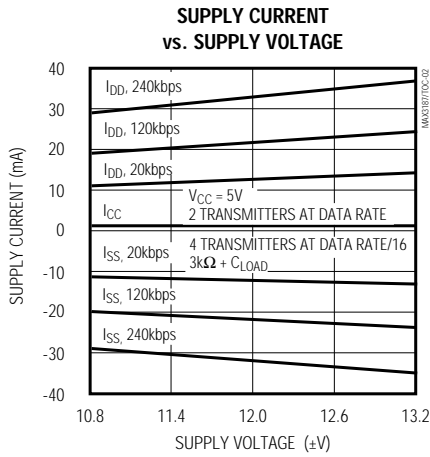

# ±15kV ESD-Protected, EMC-Compliant, 230kbps, Dual RS-232 Serial Port for Motherboards/Desktops

MAX3187

## Pin Description

PIN	NAME	FUNCTION
1, 2, 3, 6, 8, 11, 12, 13, 16, 18	R10OUT–R100OUT	Receiver Outputs, swing between GND and VCC
4, 5, 7, 14, 15, 17	T11IN–T6IN	Transmitter Inputs
9	VCC	Supply-Voltage Input, 4.5V to 5.5V
10	VSS	Supply-Voltage Input, -10.8V to -13.2V
27	GND	Ground. Connect system to ground.
28	VDD	Supply-Voltage Input, 10.8V to 13.2V
19, 21, 24, 25, 26, 29, 31, 34, 35, 36	R10IN–R11IN	Receiver Inputs
20, 22, 23, 30, 32, 33	T6OUT–T10OUT	Transmitter Outputs, swing between VDD and VSS

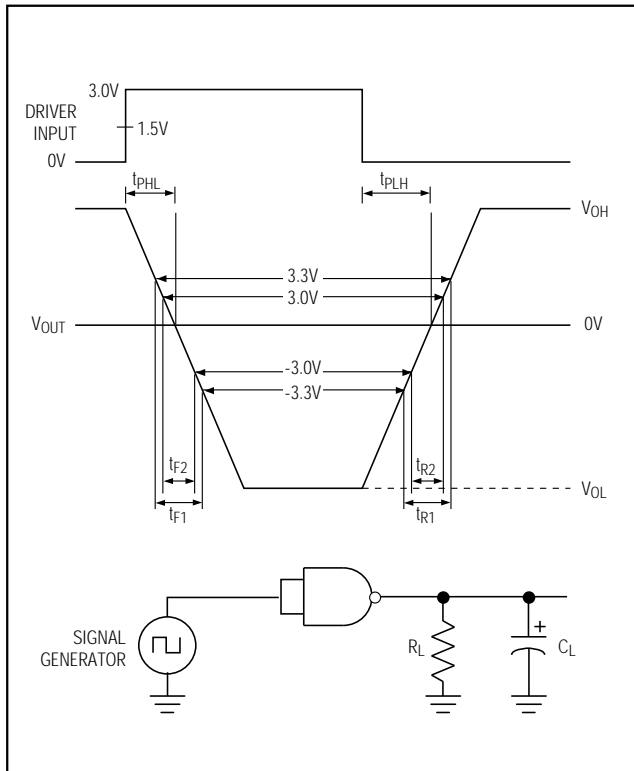

Figure 1. Slew-Rate Test Circuit and Timing Diagram

## Detailed Description

### ±15kV ESD Protection

As with all Maxim devices, ESD-protection structures are incorporated on all pins to protect against electrostatic discharges (ESD) encountered during handling and assembly. The MAX3187 driver outputs and receiver inputs have extra protection against static electricity found in normal operation. Maxim's engineers developed state-of-the-art structures to protect these pins against ±15kV ESD, without damage. After an ESD event, the MAX3187 continues working without latchup.

ESD protection can be tested in several ways. The transmitter outputs and receiver inputs are characterized for protection to the following:

- 1) ±15kV using the Human Body Model
- 2) ±8kV using the Contact-Discharge Method specified in IEC 1000-4-2 (formerly IEC 801-2)
- 3) ±15kV using the Air-Gap Method specified in IEC 1000-4-2 (formerly IEC 801-2)

### ESD Test Conditions

ESD performance depends on a number of conditions. Contact Maxim for a reliability report that documents test setup, methodology, and results.

# ±15kV ESD-Protected, EMC-Compliant, 230kbps, Dual RS-232 Serial Port for Motherboards/Desktops

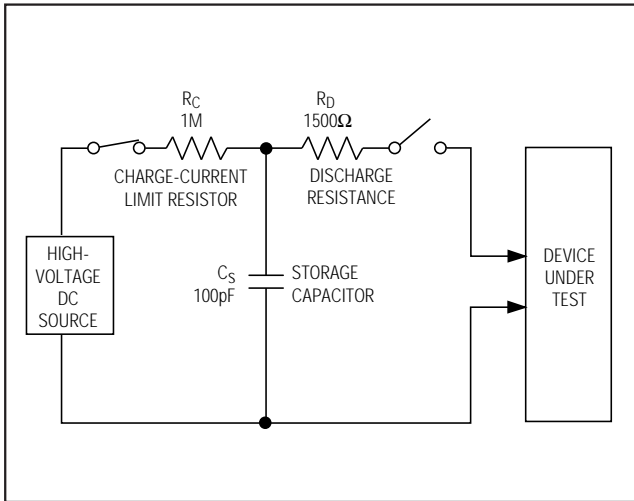

Figure 2a. Human Body ESD Test Model

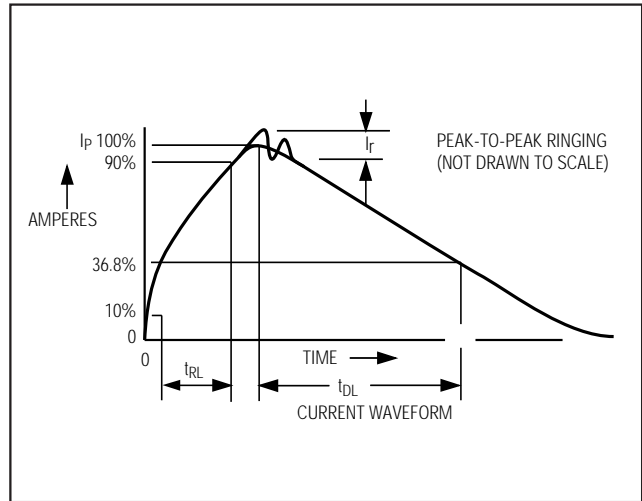

Figure 2b. Human Body Model Current Waveform

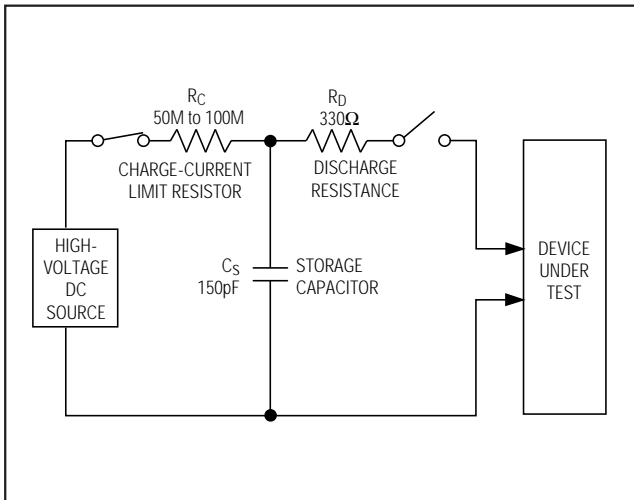

Figure 3a. IEC 1000-4-2 ESD Test Model

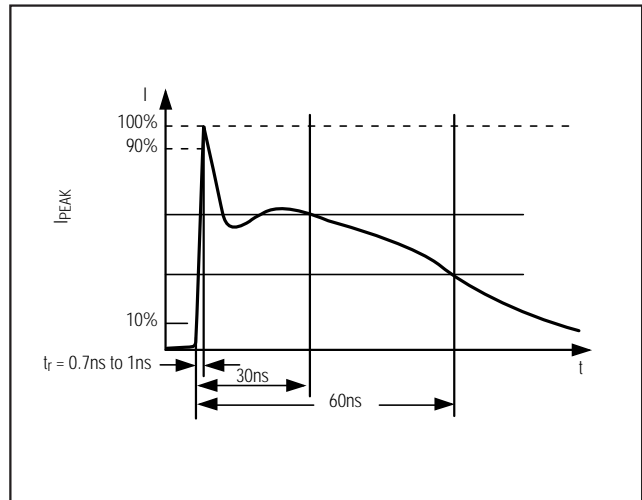

Figure 3b. IEC 1000-4-2 ESD-Generator Current Waveform

### Human Body Model

Figure 2a shows the Human Body Model, and Figure 2b shows the current waveform it generates when discharged into a low impedance. This model consists of a 100pF capacitor charged to the ESD voltage of interest, which is then discharged into the device through a 1.5kΩ resistor.

### IEC 1000-4-2

Since January 1996, all equipment manufactured and/or sold in the European community has been required to meet the stringent IEC 1000-4-2 specification. The IEC 1000-4-2 standard covers ESD testing and performance of finished equipment; it does not specifically refer to integrated circuits. The MAX3187

helps you design equipment that meets Level 4 (the highest level) of IEC 1000-4-2, without additional ESD-protection components.

The main difference between tests done using the Human Body Model and IEC 1000-4-2 is higher peak current in IEC 1000-4-2. Because series resistance is lower in the IEC 1000-4-2 ESD test model (Figure 3a), the ESD withstand voltage measured to this standard is generally lower than that measured using the Human Body Model. Figure 3b shows the current waveform for the ±8kV IEC 1000-4-2 Level 4 ESD Contact-Discharge test.

The Air-Gap test involves approaching the device with a charge probe. The Contact-Discharge method connects the probe to the device before the probe is energized.

# ±15kV ESD-Protected, EMC-Compliant, 230kbps, Dual RS-232 Serial Port for Motherboards/Desktops

## Machine Model

The Machine Model for ESD testing uses a 200pF storage capacitor and zero-discharge resistance. It mimics the stress caused by handling during manufacturing and assembly. Of course, all pins (not just RS-232 inputs and outputs) require this protection during manufacturing. Therefore, the Machine Model is less relevant to the I/O ports than are the Human Body Model and IEC 1000-4-2.

## Applications Information

Use proper layout to ensure other devices on your board are not damaged in an ESD strike. Currents as high as 60A can instantaneously pass into ground, so be sure to minimize the ground-lead return path to the power supply. A separate return path to the power supply is recommend. Trace widths should be greater than 40 mils. Bypass VCC, VDD, and VSS with 0.1µF capacitors as close to the part as possible to ensure maximum ESD protection.

Connect any unused transmitter inputs to GND or VCC. The MAX3187 is not sensitive to power-supply sequencing, and therefore requires no external protection diodes.

## Chip Information

TRANSISTOR COUNT: 419

## Typical Operating Circuit

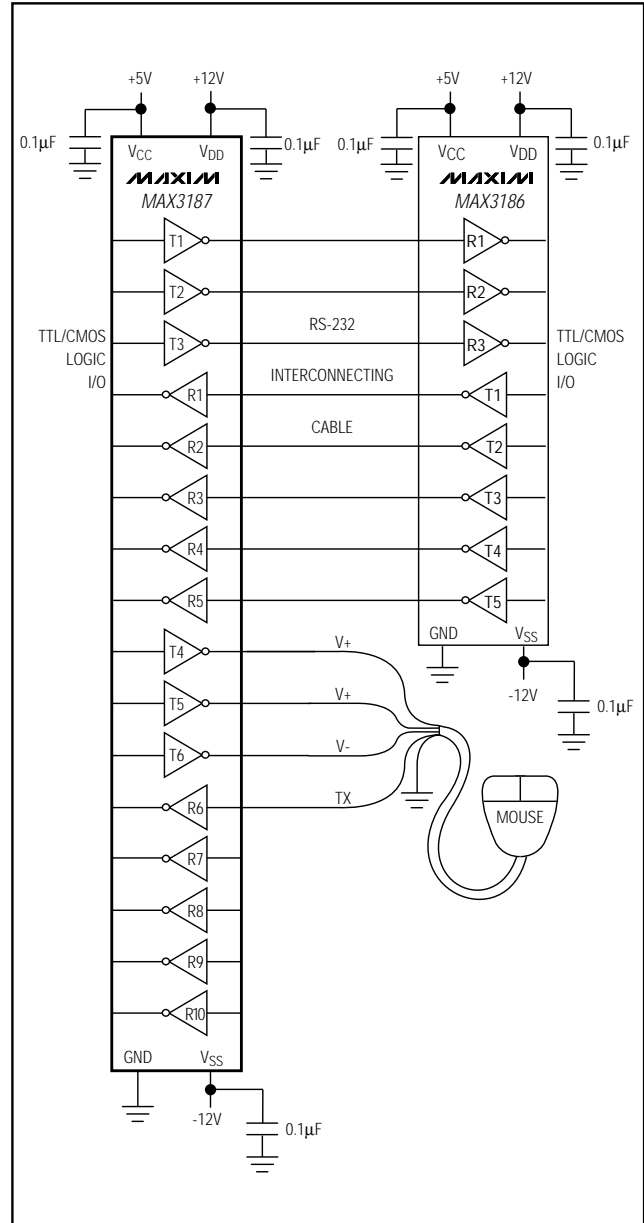

MAX3187

# ±15kV ESD-Protected, EMC-Compliant, 230kbps, Dual RS-232 Serial Port for Motherboards/Desktops

## Package Information

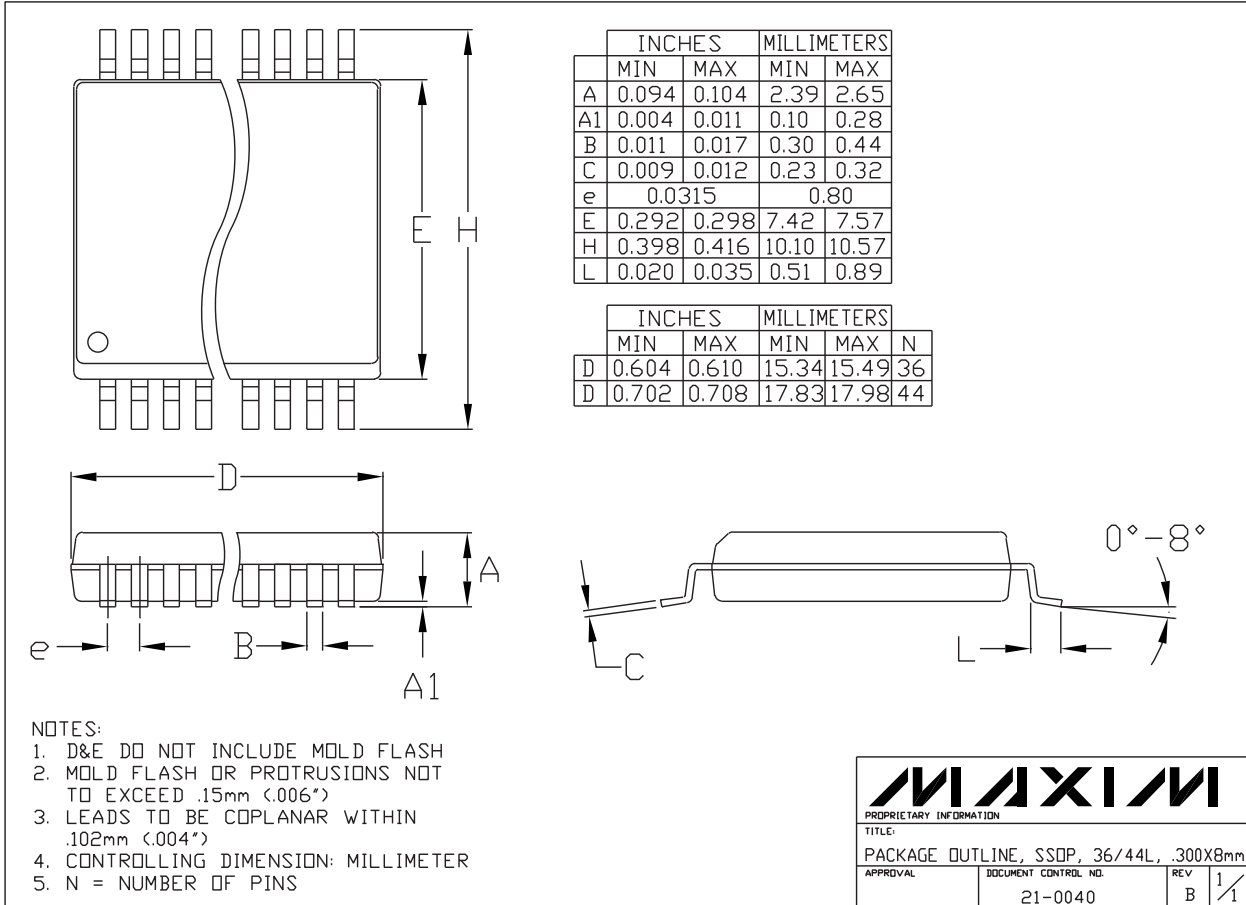

Maxim cannot assume responsibility for use of any circuitry other than circuitry entirely embodied in a Maxim product. No circuit patent licenses are implied. Maxim reserves the right to change the circuitry and specifications without notice at any time.

8 Maxim Integrated Products, 120 San Gabriel Drive, Sunnyvale, CA 94086 408-737-7600