

DESCRIPTION

The M54566P, 7-channel sink driver, consists of 7 PNP and 14 NPN transistors connected to form high current gain driver pairs.

FEATURES

- High output sustaining voltage to 50V
- High output sink current to 400mA
- "L" Active input
- Wide operating temperature range ($T_a = -20 \sim +75^\circ\text{C}$)

APPLICATION

Relay and printer driver, Interfacing between standard MOS/BIPOLAR logics

FUNCTION

The M54566P is comprised of seven PNP invertors with 8 kΩ series input resistors and NPN darlington sink drivers. The output is turned ON by switching the input low. The outputs are capable of sinking 400mA and will withstand 50V in the OFF state.

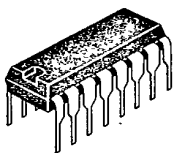

16-pin molded plastic DIP

PIN CONFIGURATION (TOP VIEW)

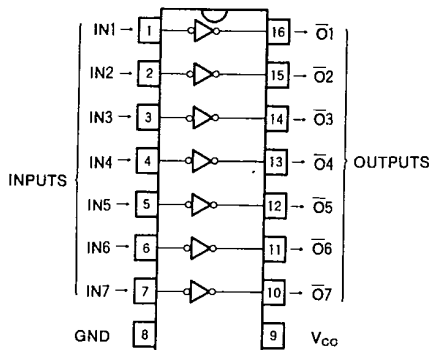

Outline 16P4

CIRCUIT SCHEMATIC

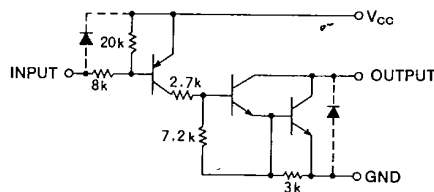

Unit : Ω

ABSOLUTE MAXIMUM RATINGS ($T_a = -20 \sim +75^\circ\text{C}$, unless otherwise noted)

Symbol	Parameter	Conditions	Ratings	Unit
V_{CC}	Supply voltage		10	V
V_{CEO}	Output sustaining voltage	Transistor OFF	-0.5 ~ +50	V
V_i	Input voltage		0 ~ V_{CC}	V
I_c	Collector current	Transistor ON	400	mA
P_d	Power dissipation	$T_a = 25^\circ\text{C}$	1.47	W
T_{opr}	Operating ambient temperature range		-20 ~ +75	$^\circ\text{C}$
T_{stg}	Storage temperature range		-55 ~ +125	$^\circ\text{C}$

RECOMMENDED OPERATIONAL CONDITIONS ($T_a = -20 \sim +75^\circ\text{C}$, unless otherwise noted)

Symbol	Parameter	Limits			Unit
		Min	Typ	Max	
V_{CC}	Supply voltage	4	5	8	V
I_C	Collector current per channel	Percent duty cycle less than 10%	0	350	mA
		Percent duty cycle less than 30%	0	200	
V_{IH}	"H" Input voltage	$I_o(\text{leak})=50\mu\text{A}$	$V_{CC}-0.2$	V_{CC}	V
V_{IL}	"L" Input voltage	$I_C=350\text{mA}$	0	$V_{CC}-3$	V

ELECTRICAL CHARACTERISTICS ($T_a = -20 \sim +75^\circ\text{C}$, unless otherwise noted)

Symbol	Parameter	Test conditions	Limits			Unit
			Min	Typ	Max	
$V_{(BR)CEO}$	Output sustaining voltage	$I_{CEO}=100\mu\text{A}$	50			V
$V_{CE(sat)}$	Output saturation voltage	$V_i = V_{CC}-3\text{V}$		1.1	2.2	V
			$I_C=350\text{mA}$			
I_i	Input current	$V_i = V_{CC}-3.5\text{V}$		-0.38	-0.58	mA
I_{CC}	Supply current	$V_{CC}=5\text{V}, V_i = V_{CC}-3.5\text{V}$		1.4	3	mA
h_{FE}	DC forward current gain	$V_{CE}=4\text{V}, V_{CC}=5\text{V}, I_C=350\text{mA}, T_a=25^\circ\text{C}$	2000	10000		—

TYPICAL CHARACTERISTICS

ALLOWABLE AVERAGE POWER DISSIPATION

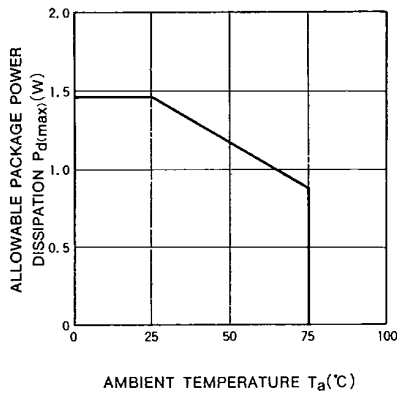

OUTPUT CURRENT CHARACTERISTICS

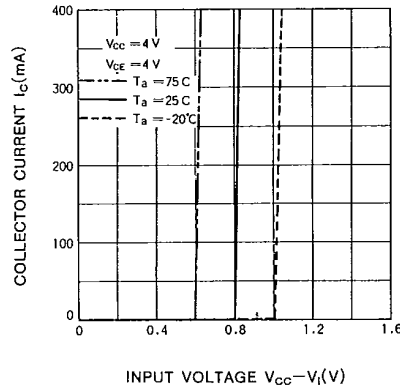

**ALLOWABLE COLLECTOR CURRENT
AS A FUNCTION OF DUTY CYCLE**

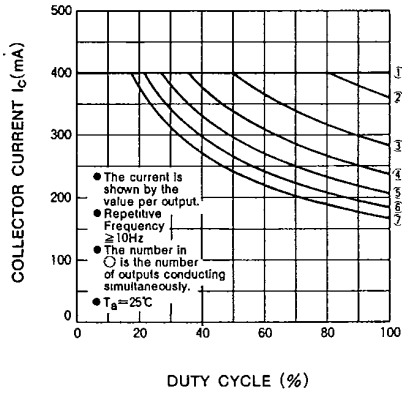

**ALLOWABLE COLLECTOR CURRENT
AS A FUNCTION OF DUTY CYCLE**

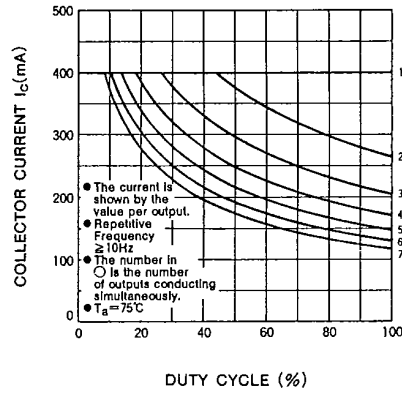

**DC CURRENT GAIN
CHARACTERISTICS**

