

SANYO

No. 4544

LC89960, 89960M**NTSC 1H Delay Line**

Overview

The LC89960 and LC89960M are delay lines and produce a 1H delayed signal for the NTSC format, with an external low-pass filter.

Functions

- 905-stage shift register
- Auto-bias circuit
- Sync tip clamp circuit
- Sample-and-hold circuit
- PLL 4 × frequency multiplier circuit
- VCO (4 fsc) output circuit

Features

- Single 5 V power supply
- The provision of a built-in 4 × frequency multiplier circuit allows the LC89960, 89960M to operate as a high bandwidth delay line from a 3.58 MHz clock input.
- Built-in peripheral circuits allow operation with minimal external circuits.
- Positive phase signal input, reverse phase signal output

Specifications

Absolute Maximum Ratings at Ta = 25°C

Parameter	Symbol	Conditions	Ratings	Unit
Maximum supply voltage	$V_{DD \text{ max}}$		-0.3 to +6.0	V
Allowable power dissipation	$P_{d \text{ max}}$	LC89960	450	mW
		LC89960M	250	mW
Operating temperature	T_{opr}		-10 to +60	°C
Storage temperature	T_{stg}		-55 to +150	°C

Package Dimensions

unit: mm

3003A-DIP14

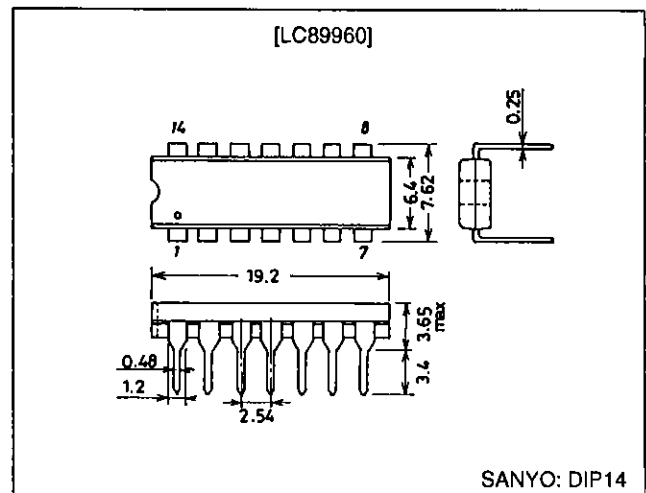

unit: mm

3034A-MFP14

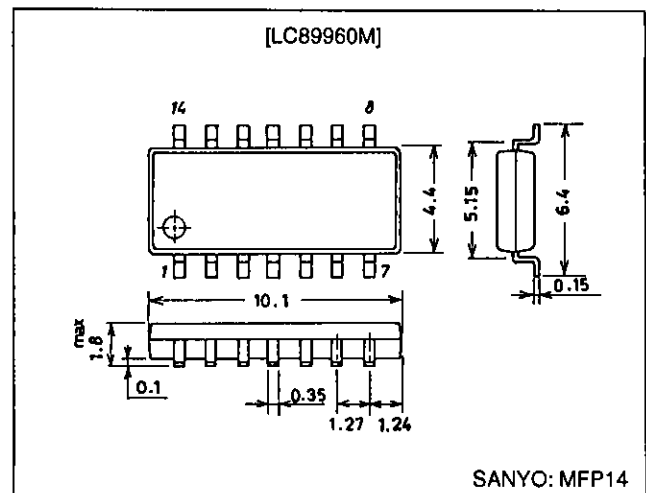

LC89960, 89960M

Allowable Operating Ranges at Ta = 25°C

Parameter	Symbol	Conditions	min	typ	max	Unit
Supply voltage	V _{DD}		4.75	5.00	5.25	V
Clock input amplitude	V _{CLK}	Sine wave	300	500	1000	mVp-p
Clock frequency	F _{CLK}			3.579545		MHz
Signal input amplitude	V _{IN}	*		500	572	mVp-p

Note: * Since sync tip clamping is normally performed, the input signal must be connected in a low impedance state.

Pin Assignment

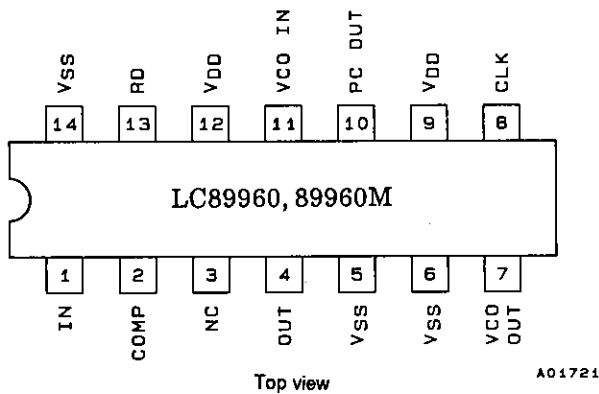

Pin Functions

Pin No.	Symbol	Function
1	IN	Signal input
2	COMP	Duty correction output
3	NC	
4	OUT	Delayed signal output
5	V _{SS}	GND
6	V _{SS}	GND
7	VCO OUT	VCO output
8	CLK	Clock input
9	V _{DD}	Power supply
10	PC OUT	Phase comparator output
11	VCO IN	VCO input
12	V _{DD}	Power supply
13	RD	High voltage generator output for Reset Drain
14	V _{SS}	GND

Block Diagram

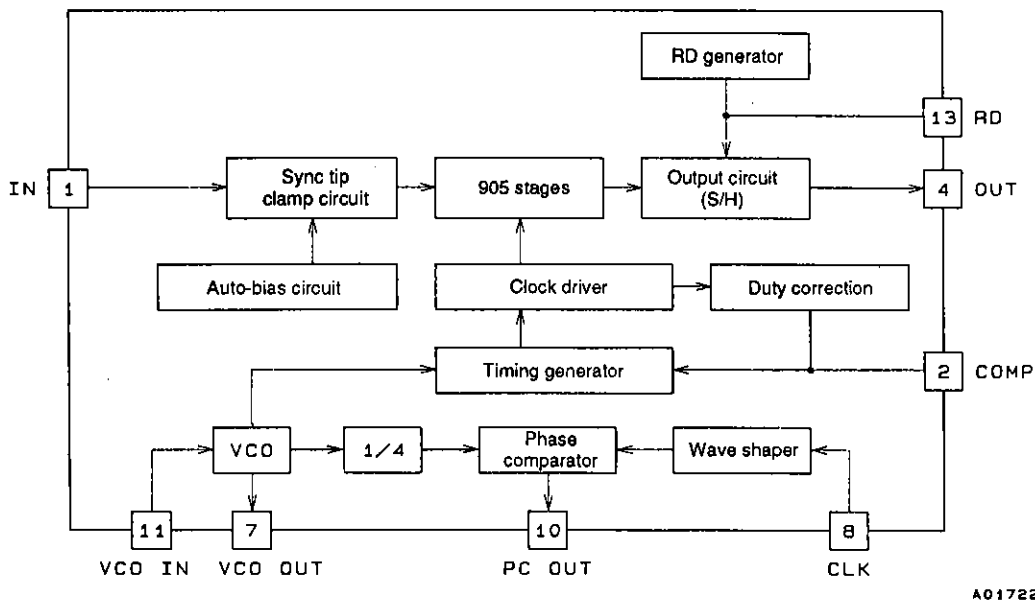

LC89960, 89960M

Electrical Characteristics at Ta = 25°C, V_{DD} = 5.0 V, CLK = 3.579545 MHz; 500 mVp-p

Parameter	Symbol	Conditions	min	typ	max	Unit
Supply current	I _{DD}	No signal input	15	25	35	mA
Voltage gain	G _V	With a 200 kHz 0.5 Vp-p input	-2.5	-0.5	+1.5	dB
Frequency response	G _f	3.58 MHz, 0.2 Vp-p/200 kHz, 0.2 Vp-p	-2	-1	0	dB
Differential gain	D _G	*1	0	5	7	%
Differential phase	D _P	*1	0	5	7	deg
Linearity (SYNC)	L _S	*2	37	40	43	%
Clock leakage	L _{CLK}	No signal input, the 4 fsc component		15	50	mVrms
Noise level	N _O	No signal input, 0.2 to 4.2 MHz bandwidth With the fsc trap		1.0	3.0	mVrms
Output impedance	Z _O		100	250	500	Ω
Delay time	T _D			63.28		μs

Note: 1. Input signal/output signal

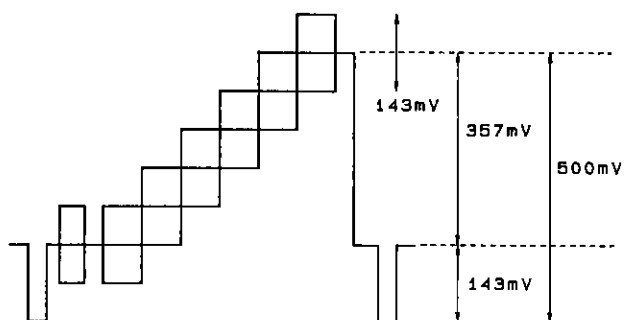

A01723

2. Input signal/output signal

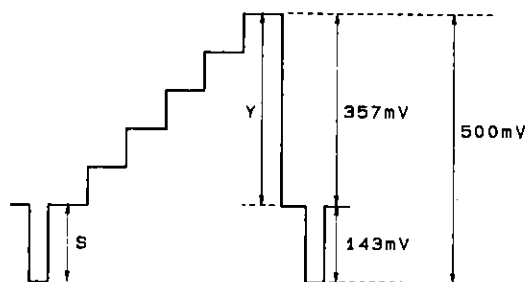

$$L_S = \frac{S}{Y}$$

A01724

Sample Application Circuit

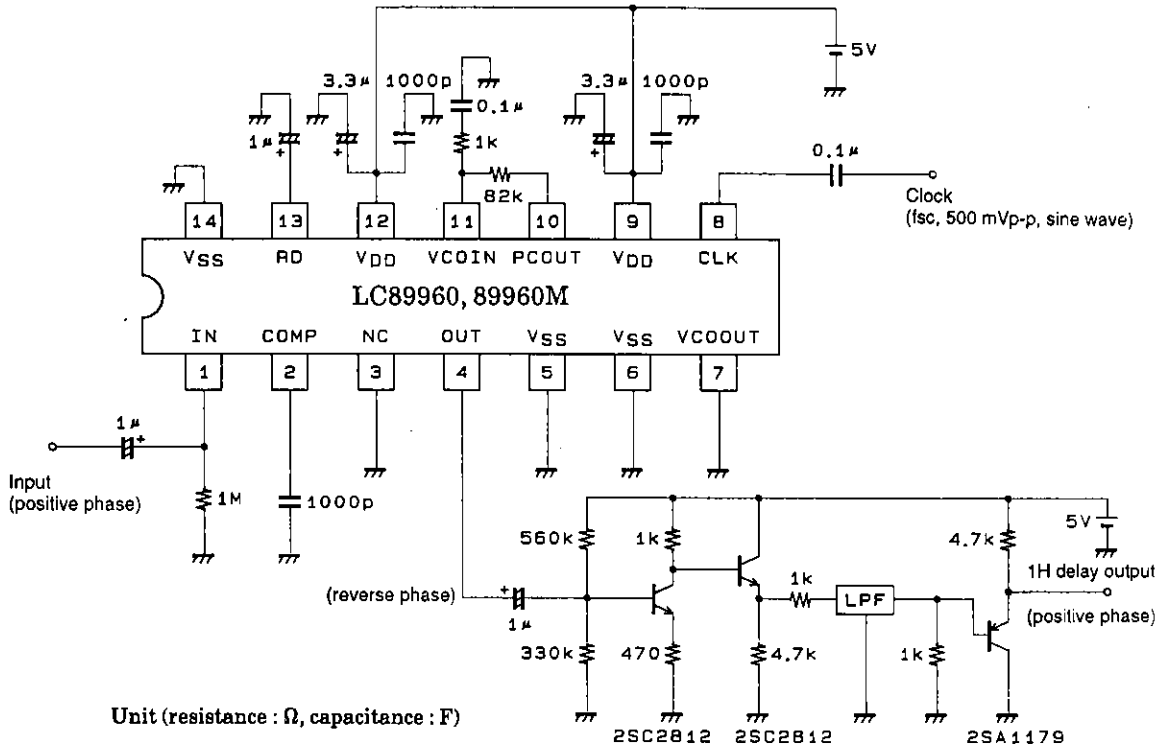

Unit (resistance : Ω, capacitance : F)

Low-pass filter delay time:
about 270 ns

A01725

When the VCO output is used
(4fsc output)

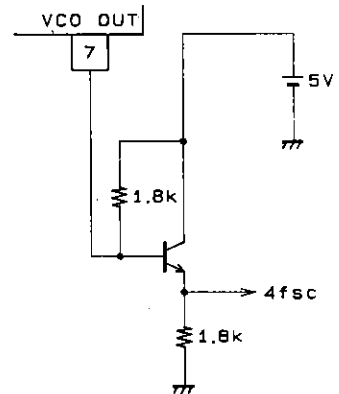

Unit (resistance : Ω, capacitance : F)

A01726

- No products described or contained herein are intended for use in surgical implants, life-support systems, aerospace equipment, nuclear power control systems, vehicles, disaster/crime-prevention equipment and the like, the failure of which may directly or indirectly cause injury, death or property loss.
- Anyone purchasing any products described or contained herein for an above-mentioned use shall:
 - ① Accept full responsibility and indemnify and defend SANYO ELECTRIC CO., LTD., its affiliates, subsidiaries and distributors and all their officers and employees, jointly and severally, against any and all claims and litigation and all damages, cost and expenses associated with such use:
 - ② Not impose any responsibility for any fault or negligence which may be cited in any such claim or litigation on SANYO ELECTRIC CO., LTD., its affiliates, subsidiaries and distributors or any of their officers and employees jointly or severally.
- Information (including circuit diagrams and circuit parameters) herein is for example only; it is not guaranteed for volume production. SANYO believes information herein is accurate and reliable, but no guarantees are made or implied regarding its use or any infringements of intellectual property rights or other rights of third parties.

This catalog provide information as of April, 1995. Specifications and Information herein are subject to change without notice.