

---

**VOLTAGE REGULATOR  
FOR MIDDLE OUTPUT CURRENT  
R×5RE SERIES**

**APPLICATION MANUAL**

### R×5RE SERIES

#### OUTLINE

The R×5RE Series are voltage regulator ICs with high output voltage accuracy and ultra-low quiescent current by CMOS process. Each of these ICs consists of a voltage reference unit, an error amplifier, a driver transistor, and resistors for setting output voltage, and a current limit circuit. By use of these ICs, a constant voltage power supply circuit with high efficiency can be constructed because the dropout voltage and quiescent current of these ICs are very small. Furthermore, these ICs have a built-in current limit circuit. The output voltage of these ICs is fixed with high accuracy.

Two types of packages, TO-92 and SOT-89 (Mini-power Mold) are available.

#### FEATURES

- Ultra-low Quiescent Current .....TYP. 1.1 $\mu$ A (R×5RE30A,  $V_{IN}=5.0V$ )
- Ultra-low Dropout Voltage .....TYP. 0.5V (R×5RE50A,  $I_{OUT}=60mA$ )
- Large Output Current .....TYP. 120mA (R×5RE50A)
- Low Temperature-Drift Coefficient of Output Voltage .....TYP.  $\pm 100$ ppm/ $^{\circ}C$
- Broad Operating Voltage Range .....MAX. 10.0V
- Excellent Line Regulation .....TYP. 0.1%/V
- High Accuracy Output Voltage ..... $\pm 2.5\%$
- Output Voltage .....Stepwise setting with a step of 0.1V in the range of 2.0V to 6.0V is possible (refer to Selection Guide)
- Two Types of Packages .....TO-92, SOT-89 (Mini-power Mold)

#### APPLICATIONS

- Power source for battery-powered equipment.
- Power source for cameras, video instruments such as camcorders, VCRs, and hand-held communication equipment.
- Precision voltage references.

#### BLOCK DIAGRAM

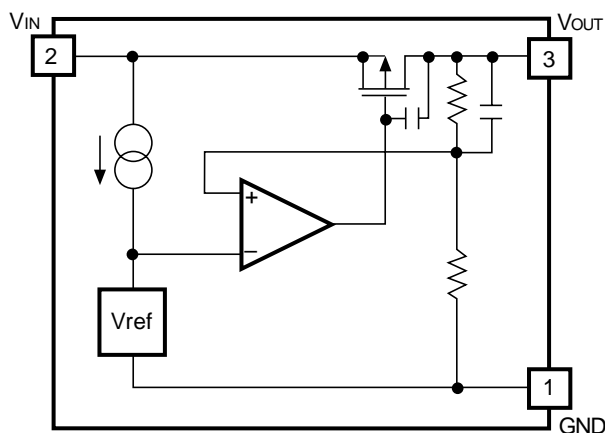

## SELECTION GUIDE

The package type, the output voltage, the packing type, and the taping type of R×5RE Series can be designated at the user's request by specifying the part number as follows.

R×5RE××××-×× ← Part Number  
 ↑     ↑↑↑↑   ↑  
 a     b c d e

Code	Contents
a	Designation of Package Type: E: TO-92 H: SOT-89 (Mini-power Mold)
b	Setting Output Voltage (V <sub>OUT</sub> ): Stepwise setting with a step of 0.1V in the range of 2.0V to 6.0V is possible.
c	A
d	Designation of Packing Type: A: Taping C: Antistatic bag for TO-92 and samples
e	Designation of Taping Type: Ex. TO-92 : RF, RR, TZ SOT-89: T1, T2 (refer to Taping Specifications) “TZ” and “T1” are prescribed as a standard.

For example, the product with Package Type SOT-89, Output Voltage 5.0V, Version A and Taping Type T1 are designated by Part Number RH5RE50AA-T1.

## PIN CONFIGURATION

### • TO-92

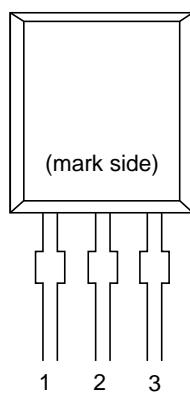

### • SOT-89

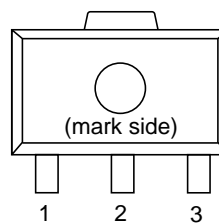

## PIN DESCRIPTION

### • TO-92

Pin No.	Symbol
1	GND
2	V <sub>IN</sub>
3	V <sub>OUT</sub>

### • SOT-89

Pin No.	Symbol
1	GND
2	V <sub>IN</sub>
3	V <sub>OUT</sub>

## ABSOLUTE MAXIMUM RATINGS

Symbol	Item	Rating	Unit
V <sub>IN</sub>	Input Voltage	+12	V
V <sub>OUT</sub>	Output Voltage	-0.3 to V <sub>IN</sub> +0.3	V
I <sub>OUT</sub>	Output Current	300	mA
P <sub>D</sub>	Power Dissipation	300	mW
T <sub>opt</sub>	Operating Temperature	-40 to +85	°C
T <sub>stg</sub>	Storage Temperature	-55 to +25	°C
T <sub>solder</sub>	Lead Temperature (Soldering)	260°C, 10s	

### ABSOLUTE MAXIMUM RATINGS

Absolute Maximum ratings are threshold limit values that must not be exceeded even for an instant under any conditions. Moreover, such values for any two items must not be reached simultaneously. Operation above these absolute maximum ratings may cause degradation or permanent damage to the device. These are stress ratings only and do not necessarily imply functional operation below these limits.

## ELECTRICAL CHARACTERISTICS

T<sub>opt</sub>=25°C

Symbol	Item	Conditions	MIN.	TYP.	MAX.	Unit
V <sub>OUT</sub>	Output Voltage	V <sub>IN</sub> =4.0V, I <sub>OUT</sub> =10mA	1.950	2.000	2.050	V
I <sub>OUT</sub>	Output Current	V <sub>IN</sub> =4.0V	40	60		mA
$\frac{\Delta V_{OUT}}{\Delta I_{OUT}}$	Load Regulation	V <sub>IN</sub> =4.0V 1mA ≤ I <sub>OUT</sub> ≤ 50mA		40	80	mV
V <sub>DIF</sub>	Dropout Voltage	I <sub>OUT</sub> =30mA		0.5	0.7	V
I <sub>SS</sub>	Quiescent Current	V <sub>IN</sub> =4.0V		1.0	3.0	μA
$\frac{\Delta V_{OUT}}{\Delta V_{IN}}$	Line Regulation	I <sub>OUT</sub> =10mA V <sub>OUT</sub> +1.0V ≤ V <sub>IN</sub> ≤ 10V		0.1		%/V
V <sub>IN</sub>	Input Voltage				10	V
I <sub>lim</sub>	Current Limit			240		mA
$\frac{\Delta V_{OUT}}{\Delta T_{opt}}$	Output Voltage Temperature Coefficient	I <sub>OUT</sub> =10mA -40°C ≤ T <sub>opt</sub> ≤ 85°C		±100		ppm/°C

## • R×5RE30A

T<sub>opt</sub>=25°C

Symbol	Item	Conditions	MIN.	TYP.	MAX.	Unit
V <sub>OUT</sub>	Output Voltage	V <sub>IN</sub> =5.0V, I <sub>OUT</sub> =10mA	2.925	3.000	3.075	V
I <sub>OUT</sub>	Output Current	V <sub>IN</sub> =5.0V	50	80		mA
$\frac{\Delta V_{OUT}}{\Delta I_{OUT}}$	Load Regulation	V <sub>IN</sub> =5.0V 1mA ≤ I <sub>OUT</sub> ≤ 60mA		40	80	mV
V <sub>DIF</sub>	Dropout Voltage	I <sub>OUT</sub> =40mA		0.5	0.7	V
I <sub>SS</sub>	Quiescent Current	V <sub>IN</sub> =5.0V		1.1	3.3	μA
$\frac{\Delta V_{OUT}}{\Delta V_{IN}}$	Line Regulation	I <sub>OUT</sub> =10mA V <sub>OUT</sub> +1.0V ≤ V <sub>IN</sub> ≤ 10V		0.1		%/V
V <sub>IN</sub>	Input Voltage				10	V
I <sub>lim</sub>	Current Limit			240		mA
$\frac{\Delta V_{OUT}}{\Delta T_{opt}}$	Output Voltage Temperature Coefficient	I <sub>OUT</sub> =10mA -40°C ≤ T <sub>opt</sub> ≤ 85°C		±100		ppm/°C

## • R×5RE40A

T<sub>opt</sub>=25°C

Symbol	Item	Conditions	MIN.	TYP.	MAX.	Unit
V <sub>OUT</sub>	Output Voltage	V <sub>IN</sub> =6.0V, I <sub>OUT</sub> =10mA	3.900	4.000	4.100	V
I <sub>OUT</sub>	Output Current	V <sub>IN</sub> =6.0V	65	100		mA
$\frac{\Delta V_{OUT}}{\Delta I_{OUT}}$	Load Regulation	V <sub>IN</sub> =6.0V 1mA ≤ I <sub>OUT</sub> ≤ 70mA		40	80	mV
V <sub>DIF</sub>	Dropout Voltage	I <sub>OUT</sub> =50mA		0.5	0.7	V
I <sub>SS</sub>	Quiescent Current	V <sub>IN</sub> =6.0V		1.2	3.6	μA
$\frac{\Delta V_{OUT}}{\Delta V_{IN}}$	Line Regulation	I <sub>OUT</sub> =10mA V <sub>OUT</sub> +1.0V ≤ V <sub>IN</sub> ≤ 10V		0.1		%/V
V <sub>IN</sub>	Input Voltage				10	V
I <sub>lim</sub>	Current Limit			240		mA
$\frac{\Delta V_{OUT}}{\Delta T_{opt}}$	Output Voltage Temperature Coefficient	I <sub>OUT</sub> =10mA -40°C ≤ T <sub>opt</sub> ≤ 85°C		±100		ppm/°C

## • R×5RE50A

T<sub>opt</sub>=25°C

Symbol	Item	Conditions	MIN.	TYP.	MAX.	Unit
V <sub>OUT</sub>	Output Voltage	V <sub>IN</sub> =7.0V, I <sub>OUT</sub> =10mA	4.875	5.000	5.125	V
I <sub>OUT</sub>	Output Current	V <sub>IN</sub> =7.0V	80	120		mA
$\frac{\Delta V_{OUT}}{\Delta I_{OUT}}$	Load Regulation	V <sub>IN</sub> =7.0V 1mA ≤ I <sub>OUT</sub> ≤ 80mA		40	80	mV
V <sub>DIF</sub>	Dropout Voltage	I <sub>OUT</sub> =60mA		0.5	0.7	V
I <sub>SS</sub>	Quiescent Current	V <sub>IN</sub> =7.0V		1.3	3.9	μA
$\frac{\Delta V_{OUT}}{\Delta V_{IN}}$	Line Regulation	I <sub>OUT</sub> =10mA V <sub>OUT</sub> +1.0V ≤ V <sub>IN</sub> ≤ 10V		0.1		%/V
V <sub>IN</sub>	Input Voltage				10	V
I <sub>lim</sub>	Current Limit			240		mA
$\frac{\Delta V_{OUT}}{\Delta T_{opt}}$	Output Voltage Temperature Coefficient	I <sub>OUT</sub> =10mA -40°C ≤ T <sub>opt</sub> ≤ 85°C		±100		ppm/°C

## • R×5RE60A

T<sub>opt</sub>=25°C

Symbol	Item	Conditions	MIN.	TYP.	MAX.	Unit
V <sub>OUT</sub>	Output Voltage	V <sub>IN</sub> =8.0V, I <sub>OUT</sub> =10mA	5.850	6.000	6.150	V
I <sub>OUT</sub>	Output Current	V <sub>IN</sub> =8.0V	80	120		mA
$\frac{\Delta V_{OUT}}{\Delta I_{OUT}}$	Load Regulation	V <sub>IN</sub> =8.0V 1mA ≤ I <sub>OUT</sub> ≤ 80mA		40	80	mV
V <sub>DIF</sub>	Dropout Voltage	I <sub>OUT</sub> =60mA		0.5	0.7	V
I <sub>SS</sub>	Quiescent Current	V <sub>IN</sub> =8.0V		1.4	4.2	μA
$\frac{\Delta V_{OUT}}{\Delta V_{IN}}$	Line Regulation	I <sub>OUT</sub> =10mA V <sub>OUT</sub> +1.0V ≤ V <sub>IN</sub> ≤ 10V		0.1		%/V
V <sub>IN</sub>	Input Voltage				10	V
I <sub>lim</sub>	Current Limit			240		mA
$\frac{\Delta V_{OUT}}{\Delta T_{opt}}$	Output Voltage Temperature Coefficient	I <sub>OUT</sub> =10mA -40°C ≤ T <sub>opt</sub> ≤ 85°C		±100		ppm/°C



## ELECTRICAL CHARACTERISTICS BY OUTPUT VOLTAGE

Part Number	Output Voltage				Output Current			Load Regulation			Dropout Voltage		
	V <sub>OUT</sub> (V)				I <sub>OUT</sub> (mA)			ΔV <sub>OUT</sub> /ΔI <sub>OUT</sub> (mV)			V <sub>DIF</sub> (V)		
	Conditions	MIN.	TYP.	MAX.	Conditions	MIN.	TYP.	Conditions	TYP.	MAX.	Conditions	TYP.	MAX.
R×5RE20A	V <sub>IN</sub> - V <sub>OUT</sub> =2.0V  I <sub>OUT</sub> =10mA	1.950	2.000	2.050	V <sub>IN</sub> - V <sub>OUT</sub> =2.0V	40	60	V <sub>IN</sub> - V <sub>OUT</sub> =2.0V	40	80	I <sub>OUT</sub> =30mA	0.5	0.7
R×5RE21A		2.048	2.100	2.152									
R×5RE22A		2.145	2.200	2.255									
R×5RE23A		2.243	2.300	2.357									
R×5RE24A		2.340	2.400	2.460									
R×5RE25A		2.438	2.500	2.562									
R×5RE26A		2.535	2.600	2.665									
R×5RE27A		2.633	2.700	2.767									
R×5RE28A		2.730	2.800	2.870									
R×5RE29A		2.828	2.900	2.972									
R×5RE30A		2.925	3.000	3.075									
R×5RE31A		3.023	3.100	3.177									
R×5RE32A		3.120	3.200	3.280									
R×5RE33A		3.218	3.300	3.382									
R×5RE34A		3.315	3.400	3.485									
R×5RE35A		3.413	3.500	3.587									
R×5RE36A		3.510	3.600	3.690									
R×5RE37A		3.608	3.700	3.792									
R×5RE38A		3.705	3.800	3.895									
R×5RE39A		3.803	3.900	3.997									
R×5RE40A		3.900	4.000	4.100									
R×5RE41A		3.998	4.100	4.202									
R×5RE42A		4.095	4.200	4.305									
R×5RE43A		4.193	4.300	4.407									
R×5RE44A		4.290	4.400	4.510									
R×5RE45A		4.388	4.500	4.612									
R×5RE46A		4.485	4.600	4.715									
R×5RE47A		4.583	4.700	4.817									
R×5RE48A		4.680	4.800	4.920									
R×5RE49A		4.778	4.900	5.022									
R×5RE50A	4.875	5.000	5.125										
R×5RE51A	4.973	5.100	5.227										
R×5RE52A	5.070	5.200	5.330										
R×5RE53A	5.168	5.300	5.432										
R×5RE54A	5.265	5.400	5.535										
R×5RE55A	5.363	5.500	5.637										
R×5RE56A	5.460	5.600	5.740										
R×5RE57A	5.558	5.700	5.842										
R×5RE58A	5.655	5.800	5.945										
R×5RE59A	5.753	5.900	6.047										
R×5RE60A	5.850	6.000	6.150										

T<sub>opt</sub>=25°C

Quiescent Current			Line Regulation		Input Voltage	Current Limit	Output Voltage Tempco.	
I <sub>SS</sub> (μA)			ΔV <sub>OUT</sub> /ΔV <sub>IN</sub> (%/V)		V <sub>IN</sub> (V)	I <sub>lim</sub> (mA)	ΔV <sub>OUT</sub> /ΔT(ppm/°C)	
Conditions	TYP.	MAX.	Conditions	TYP.	MAX.	TYP.	Conditions	TYP.
V <sub>IN</sub> - V <sub>OUT</sub> =2.0V	1.0	3.0	I <sub>OUT</sub> =10mA  V <sub>OUT</sub> + 1.0V≤ V <sub>IN</sub> ≤10V	0.1	10	240	I <sub>OUT</sub> =10mA  -40°C≤ T <sub>opt</sub> ≤85°C	±100
	1.1	3.3						
	1.2	3.6						
	1.3	3.9						
	1.4	4.2						

## OPERATION

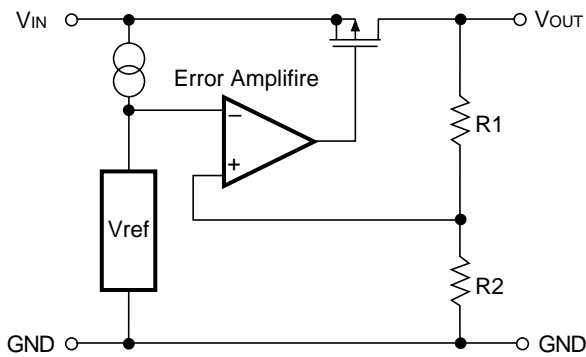

FIG. 1 Block Diagram

Output Voltage  $V_{out}$  divided at the node between Registers R1 and R2 is compared with Reference Voltage by Error Amplifier, so that a constant voltage is output.

## TEST CIRCUITS

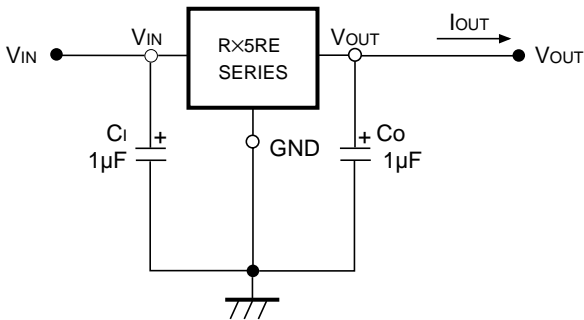

FIG. 2 Test Circuit

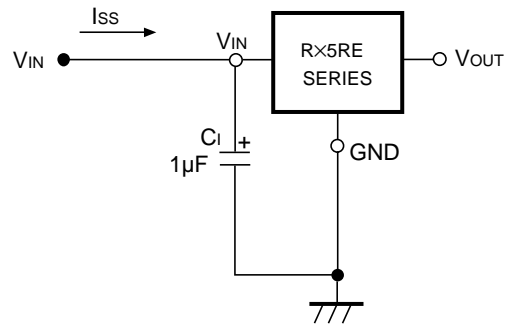

FIG. 3 Quiescent Current Test Circuit

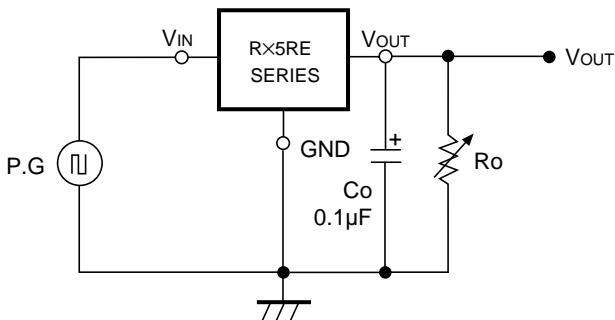
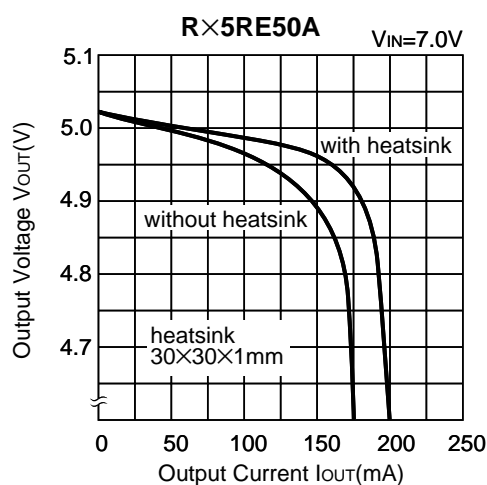
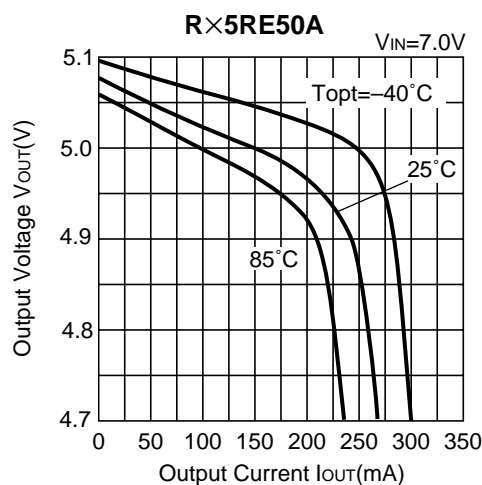
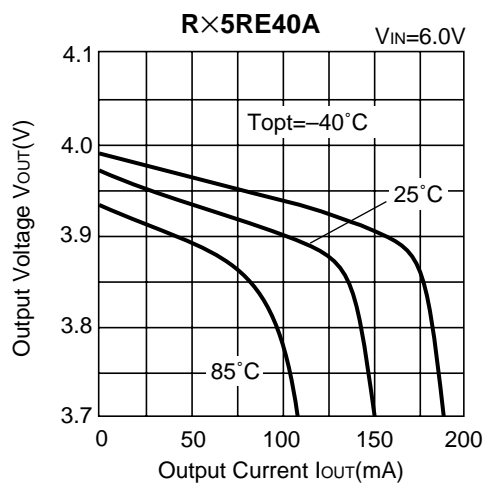
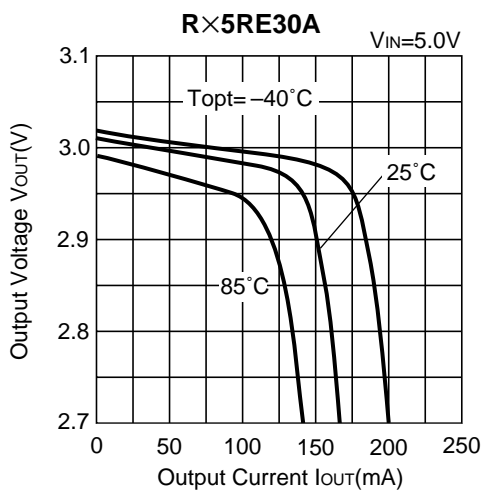

FIG. 4 Line Transient Response Test Circuit

# TYPICAL CHARACTERISTICS

## 1) Output Voltage vs. Output Current



## 2) Output Voltage vs. Input Voltage

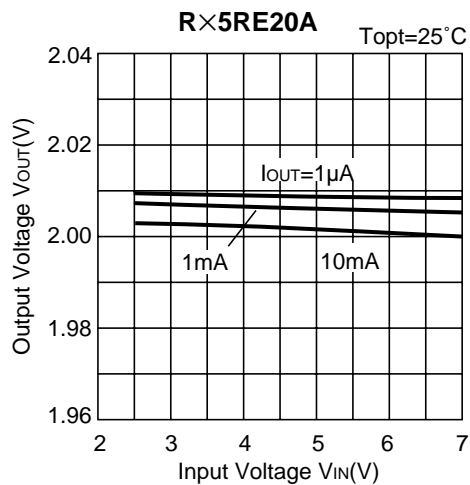
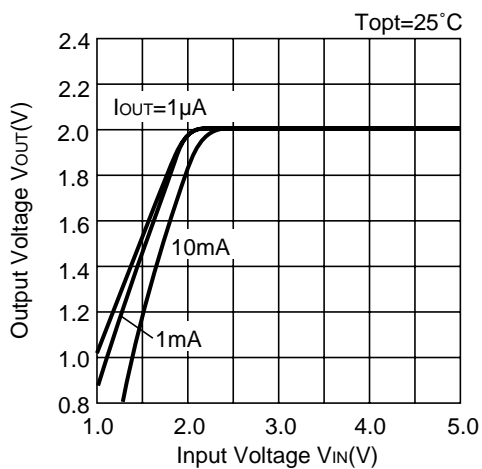

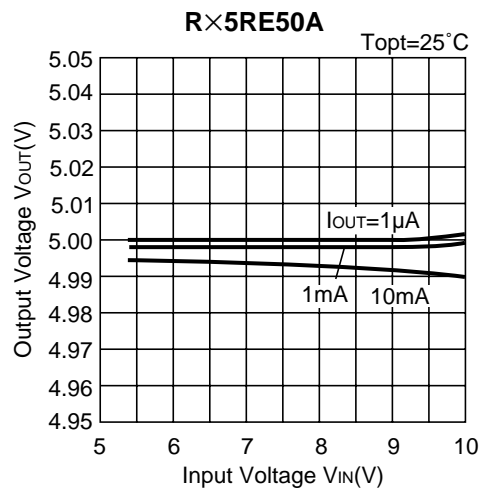
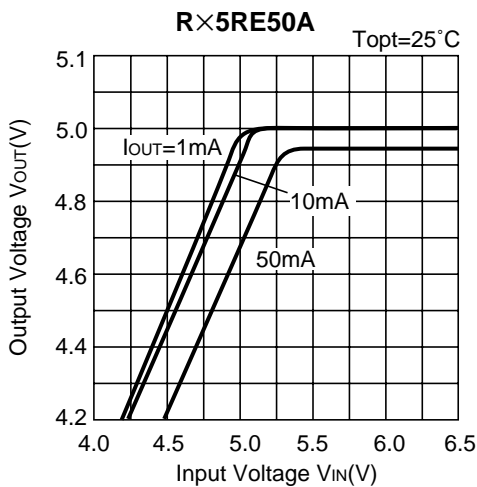
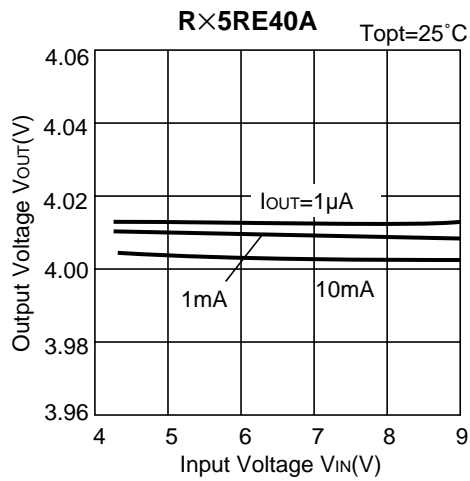
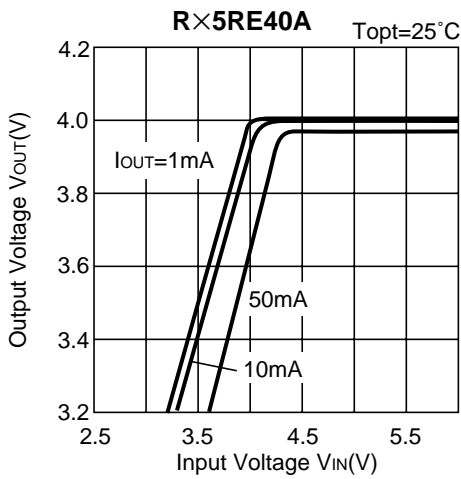
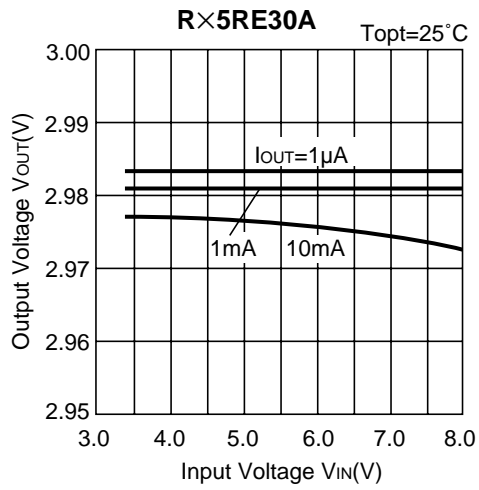
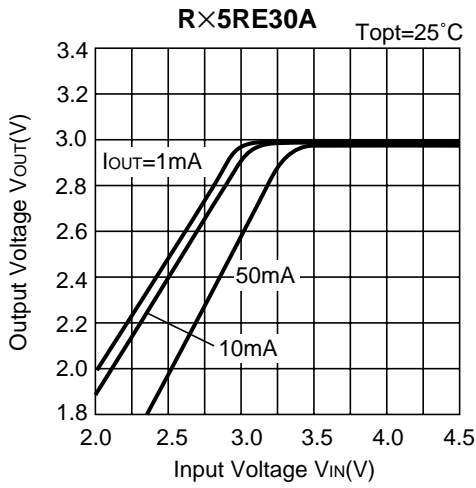

3) Dropout Voltage vs. Output Current

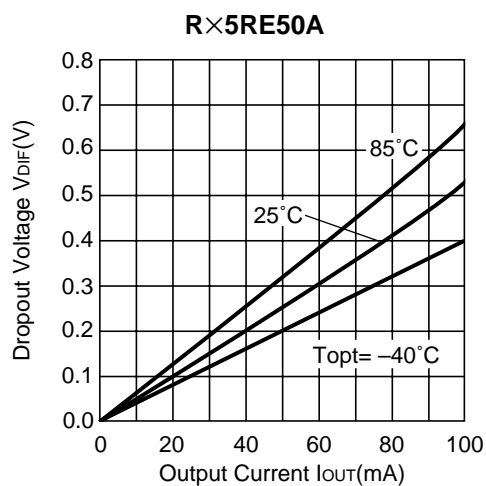
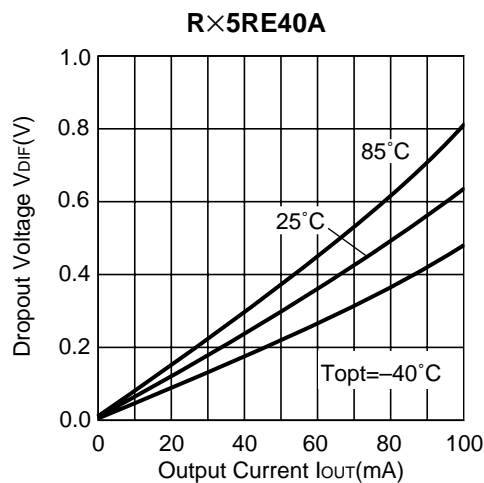
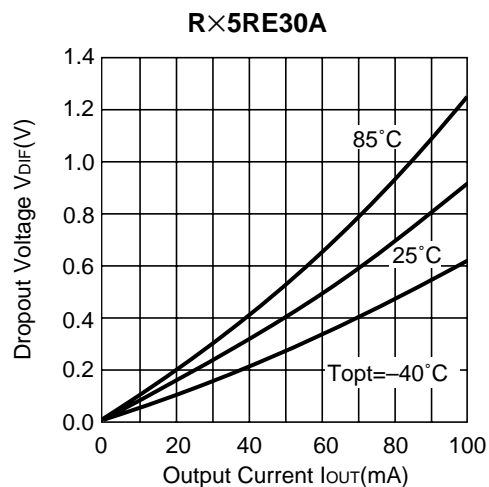

4) Output Voltage vs. Temperature

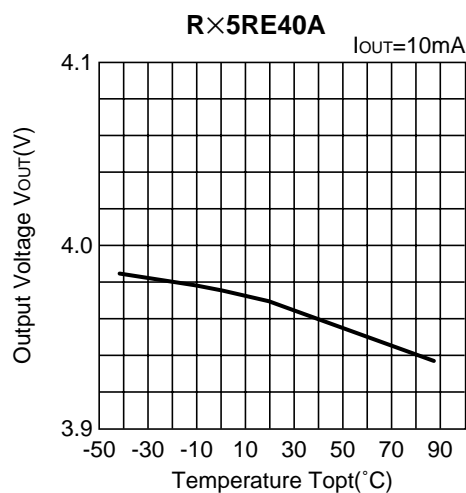
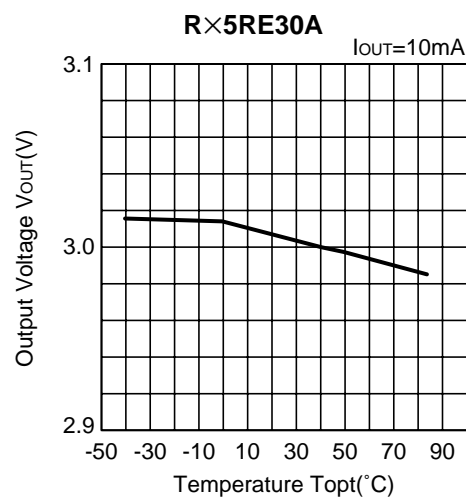

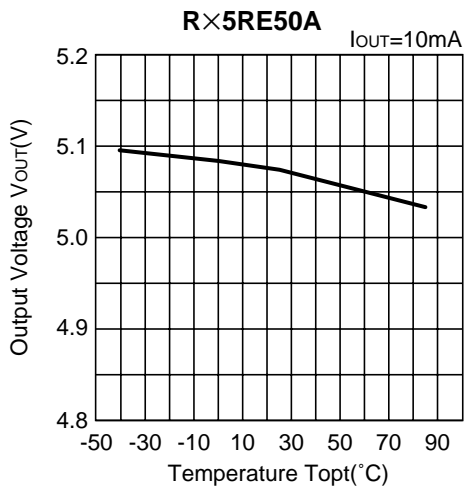

5) Quiescent Current vs. Input Voltage

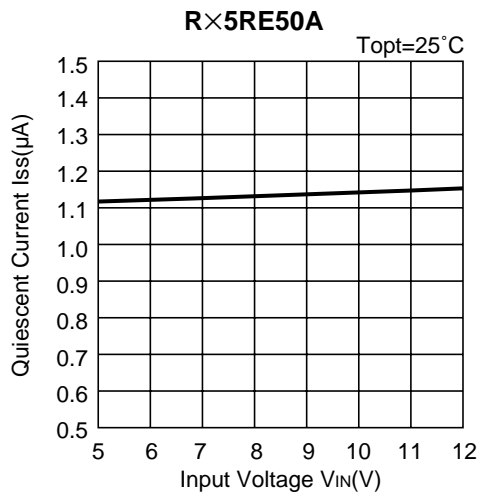
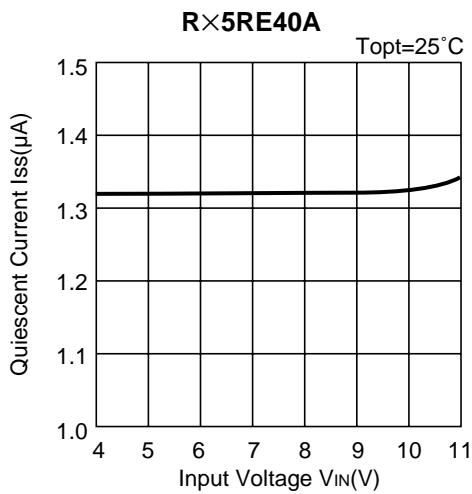
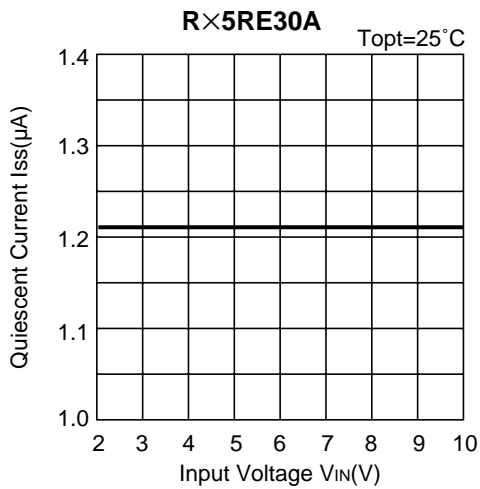
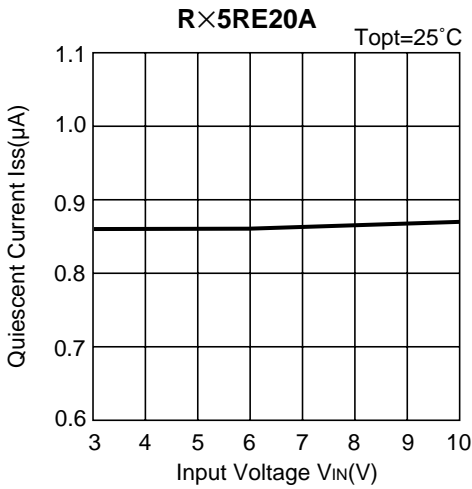

6) Quiescent Current vs. Temperature

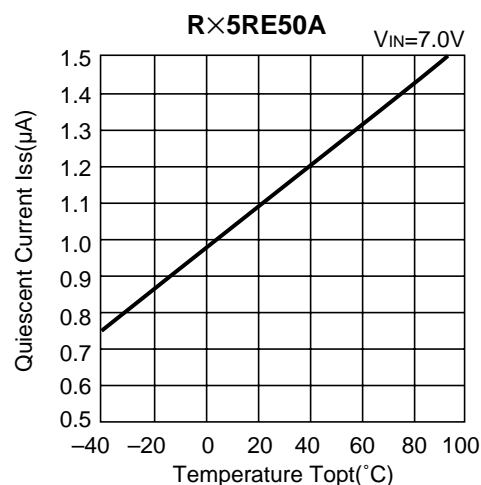
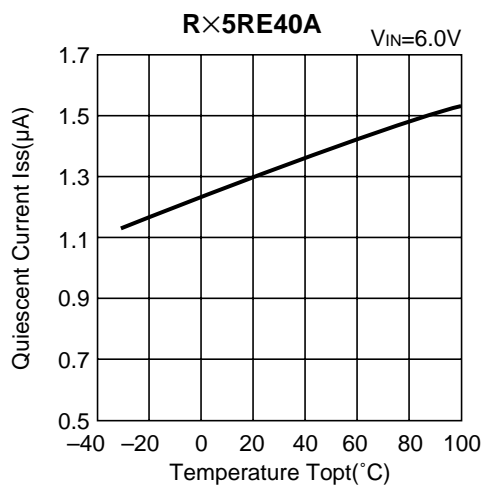
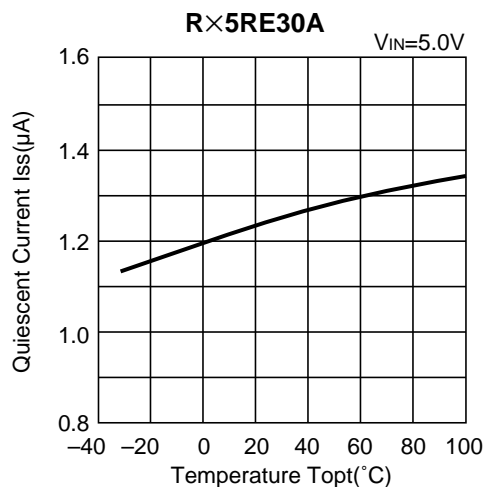
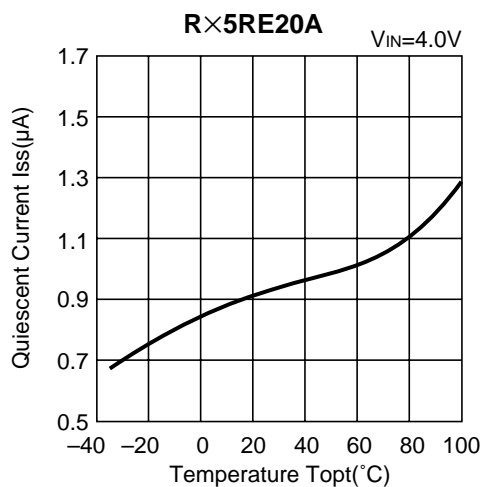

7) Dropout Voltage vs. Set Output Voltage

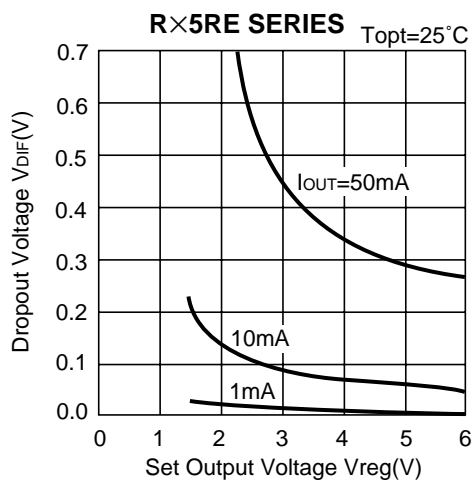



8) Line Transient Response (1)

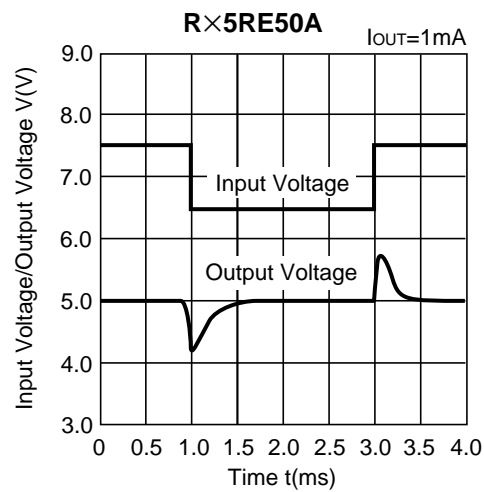
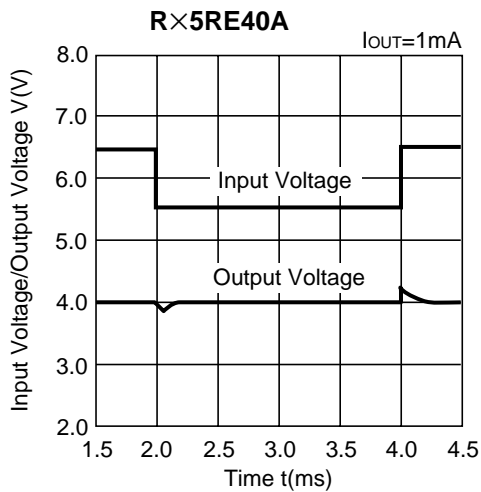
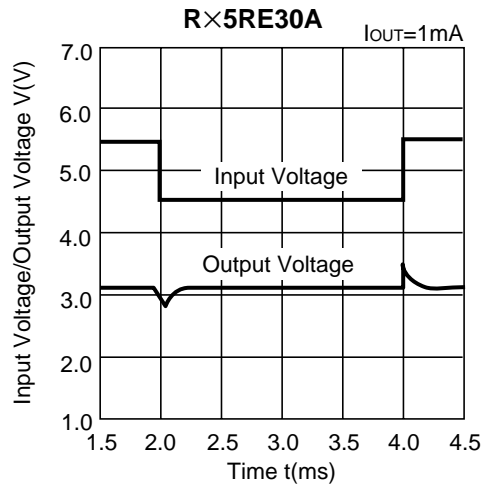
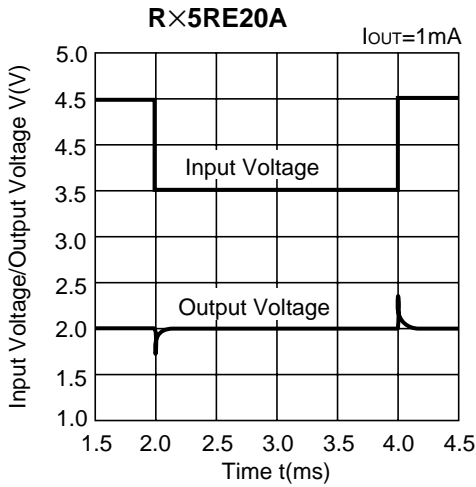

9) Line Transient Response (2)

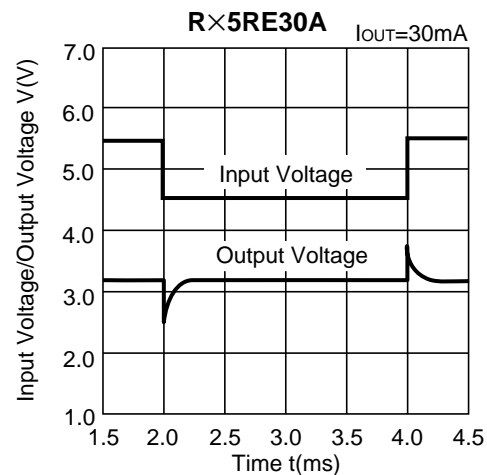
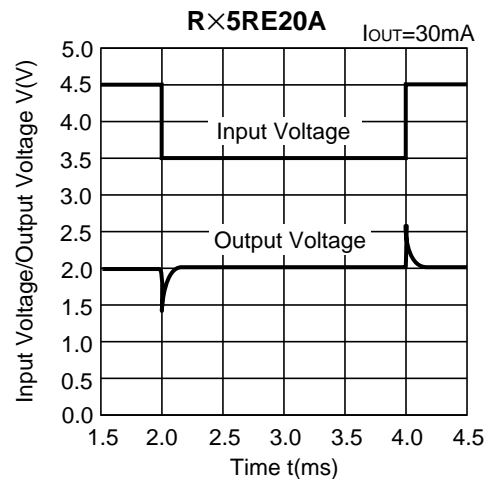

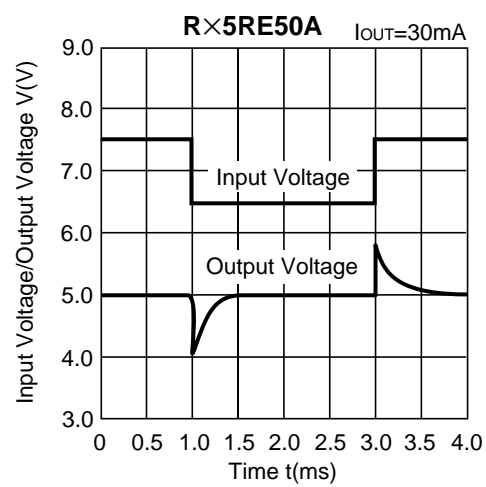
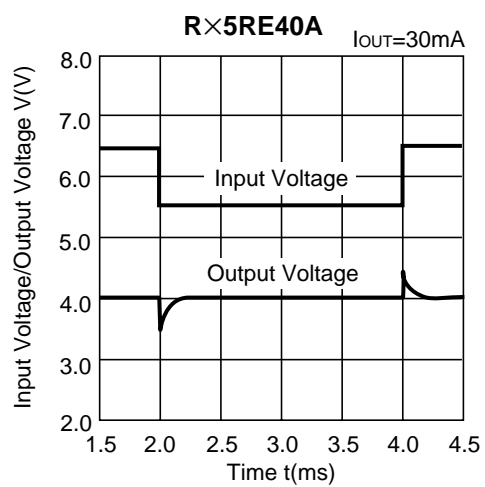

## TYPICAL APPLICATION

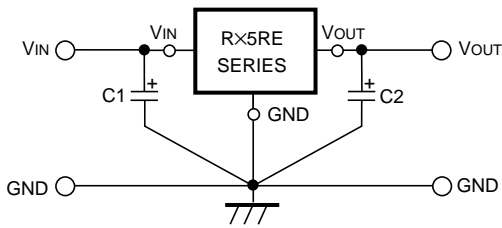

In R×5RE Series, a constant voltage can be obtained without using Capacitors C1 and C2. However, when the wire connected to VIN is long, use Capacitor C1. Output noise can be reduced by using Capacitor C2.

Insert Capacitors C1 and C2 with the capacitance of 0.1μF to 2.0μF between Input/Output Pins and GND Pin with minimum wiring.

## APPLICATION CIRCUITS

### • VOLTAGE BOOST CIRCUIT

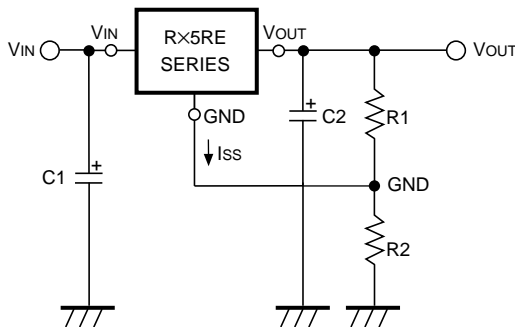

The output voltage can be obtained by the following formula :

$$V_{OUT} = V_{reg}^{*1} \cdot (1 + R_2/R_1) + I_{SS} \cdot R_2$$

Since the quiescent current of R×5RE Series is so small that the resistances of R1 and R2 can be set as large as several hundreds kΩ and therefore the supply current of “Voltage Boost Circuit” itself can be reduced.

Furthermore, since R×5RE Series are operated by a constant voltage, the supply current of “Voltage Boost Circuit” is not substantially affected by the input voltage.

\*1) Vreg : Set Output Voltage of R×5RE Series.

### • DUAL POWER SUPPLY CIRCUIT

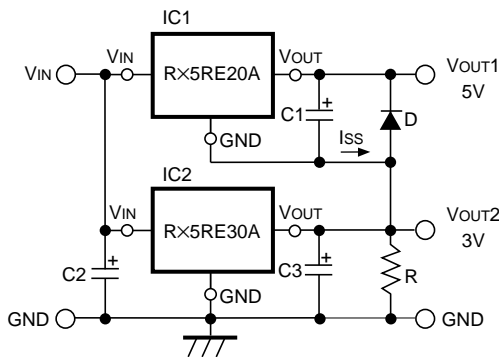

As shown in the circuit diagram, a dual power supply circuit can be constructed by using two R×5RE Series.

This circuit diagram shows a dual power supply circuit with an output of 3V and an output of 5V. When the minimum output current of IC2 is larger than ISS of IC1, Resistor R is unnecessary. Diode D is a protection diode for the case where VOUT2 becomes larger than VOUT1.

• CURRENT BOOST CIRCUIT

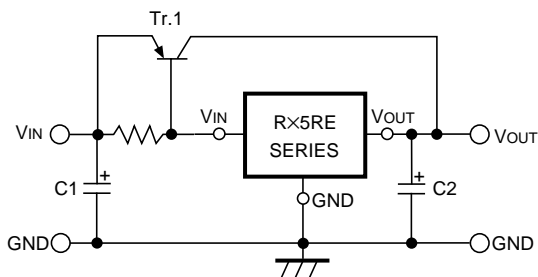

Output current of 120mA or more can be obtained by the current boost circuit constructed as shown in this circuit diagram.

• CURRENT BOOST CIRCUIT WITH OVERCURRENT LIMIT CIRCUIT

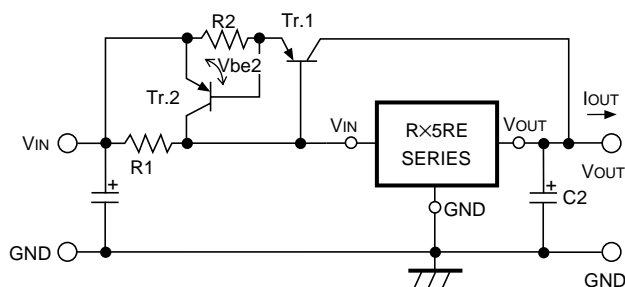

A circuit for protecting Tr.1 from the destruction caused by output short-circuit or overcurrent is shown in this circuit diagram.

When the voltage reduction caused by the current ( $I_{OUT}$ ) which flows through R2 reaches  $V_{be2}$  of Tr.2 by additionally providing the current boost circuit with Tr.2 and R2, Tr.2 is turned ON and the base current of Tr.1 is increased, so that the output current is limited.

Current limit of Overcurrent Limit Circuit is obtained as follows :

$$I_{OUT} \approx V_{be2}/R2$$

• CURRENT SOURCE

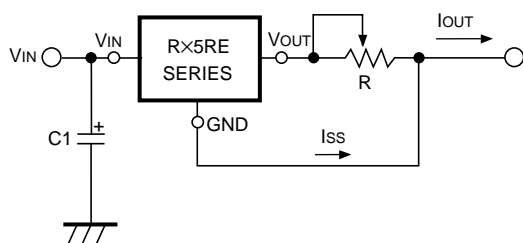

A current source with the structure as shown in this circuit diagram can be used. Output Current  $I_{OUT}$  is obtained as follows :

$$I_{OUT} = V_{reg}^{*1} / R + I_{SS}$$

Take care that Output Current  $I_{OUT}$  does not exceed its allowable current.

\*1)  $V_{reg}$  : Set Output Voltage of R×5RE Series.