

Wideband Video Buffer



LH4002A / LH4002 / LH4002C

FEATURES

- DC to 300 MHz Bandwidth with $V_S = \pm 5V$
- 3000 V/ μs Slew Rate into 50 Ω

APPLICATIONS

- Wideband Amplifier Buffer
- Wideband Line Driver
- Video
- Coaxial Cable Driver

GENERAL DESCRIPTION

The LH4002 family is a high speed voltage follower designed to drive video signals from DC up to 300MHz. At voltage supplies of $\pm 5V$, the LH4002 family will provide up to 80mA into 50 Ω at slew rates of 2000 V/ μs .

The LH4002 family is intended to fulfill a wide range of high speed applications including video distribution, impedance transformation, and load isolation. It is also suitable for use in current booster applications within an op amp loop. This allows the output current capability of existing op amps to be increased.

ORDERING INFORMATION

Part	Package	Temperature Range
LH4002AH	HO8A (TO5-8 Lead)	-55°C to +125°C
LH4002H	HO8A (TO5-8 Lead)	-55°C to +125°C
LH4002CH	HO8A (TO5-8 Lead)	-40°C to +85°C
LH4002AN	N10A (Plastic Dip-10 Lead)	-40°C to +85°C
LH4002N	N10A (Plastic Dip-10 Lead)	-40°C to +85°C
LH4002CN	N10A (Plastic Dip-10 Lead)	-40°C to +85°C

CONNECTION DIAGRAMS

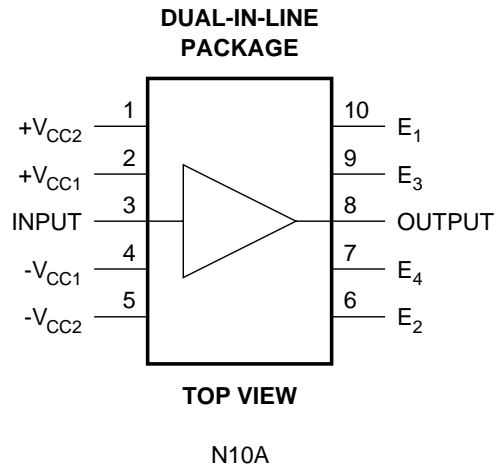
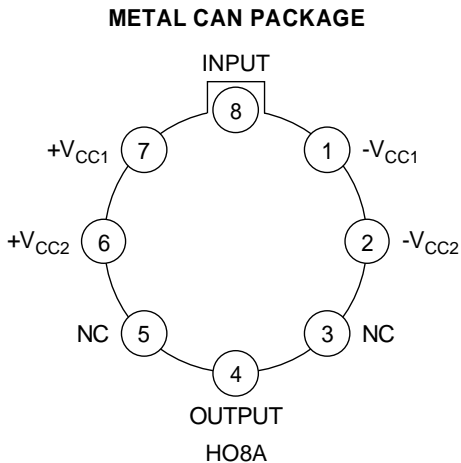

ABSOLUTE MAXIMUM RATINGS (Note 1)

Supply Voltage	± 10	ESD Tolerance (Note 3)	$\pm 2000V$
Input Voltage	$\pm V_{supply}$	Thermal Resistance (θ_{JA}) (Note 6)	
Storage Temperature Range	$-65^{\circ}C$ to $+150^{\circ}C$	H Package	$125^{\circ}C/W$
Lead Temperature		N Package	$50^{\circ}C/W$
(Soldering 10 seconds)	$260^{\circ}C$	Maximum Junction Temperature	$150^{\circ}C$
Power Dissipation	(Note 4)		

DC ELECTRICAL CHARACTERISTICS

The following specifications apply for Supply Voltage = $\pm 5V$, $V_{CM} = 0$, $R_L \geq 100K\Omega$ and $R_S = 50\Omega$ unless otherwise noted.

Boldface limits apply for $T_A = T_J = T_{MIN}$ to T_{MAX} ; all other limits $T_A = T_J = 25^{\circ}C$.

SYMBOL	CHARACTERISTICS	TYP	LH4002A	LH4002	LH4002C	UNITS	CONDITIONS
			Limit (Note 5)	Limit (Note 5)	Limit (Note 5)		
A_{V1}	Voltage Gain 1	0.99	0.96 0.95	0.95 0.95	0.95 0.95	V/V Min	$R_L = 1K, V_{IN} = \pm 2V, R_S = 10K$
A_{V2}	Voltage Gain 2	0.92	0.89	0.88	0.87		$R_L = 50\Omega, V_{IN} = \pm 3V$
A_{V3}	Voltage Gain 3	0.92	0.89	0.87	0.87		$R_L = 50\Omega, V_{IN} = \pm 2V$
V_{OS}	Offset Voltage	10	15 25	25 35	30 40	mV Max	$R_L = 50\Omega, R_S = 150\Omega$
I_B	Input Bias Current	1	10 20	15 30	20 40	μA Max	$R_L = 50\Omega, R_S = 1K\Omega$
R_{IN}	Input Resistance	0.3				M Ω	$R_S = 10K, R_L = 50\Omega$
C_{IN}	Input Capacitance	3.5				pF	
R_O	Output Resistance	3	10 10	10 10	10 10	Ω Max	$R_S = 10K, R_L = 50\Omega$
I_{S1}	Supply Current 1	20	30 35	30 35	35 35	mA Max	$R_S = 10K, V_{IN} = 0V, R_L = 1K$
V_{O1}	Output Swing 1	2.4	2.2 2.2	2.2 2.2	2.2 2.2	$\pm V$ Min	$R_S = 150\Omega, V_{IN} = \pm 2.5V, R_L = 50\Omega$
V_{O2}	Output Swing 2	2.2	2	2	2		$R_S = 150\Omega, V_{IN} = \pm 2.5V, R_L = 1K$
V_{O3}	Output Swing 3	3.6	3.0	3.0	3.0	V_{PP} Min	$R_S = 150\Omega, V_{IN} = \pm 4.5V, R_L = 50\Omega$
I_{OUT}	Output Current	80	60	60	60	mA	$V_{IN} = 4V$

AC ELECTRICAL CHARACTERISTICS

The following specifications apply for Supply Voltage = $\pm 5V$, $V_{CM} = 0$, $R_L \geq 100K\Omega$ and $R_S = 50\Omega$ unless otherwise noted.

Boldface limits apply for $T_A = T_J = T_{MIN}$ to T_{MAX} ; all other limits $T_A = T_J = 25^\circ C$.

SYMBOL	CHARACTERISTICS	TYP	LH4002A	LH4002	LH4002C	UNITS	CONDITIONS
			Limit (Note 5)	Limit (Note 5)	Limit (Note 5)		
SR ₁	Slew Rate 1	3000	2750	2500	2500	V/ μ s	$V_{IN} = \pm 2V$, $R_L = 50\Omega$ (Note 2)
SR ₂	Slew Rate 2	2000	1750	1600	1500		$V_{IN} = \pm 4V$, $R_L = 50\Omega$ (Note 2)
SS _{BW}	Small Signal Bandwidth	300	250	220	200	MHz	$R_L = 50\Omega$, $V_{OUT} = 100mV_{P-P}$
LS _{BW}	Large Signal Bandwidth	140	100	90	80		$R_L = 50\Omega$, $V_{OUT} = 2V_{P-P}$
P _{BW}	Power Bandwidth	130	100	90	80		$R_L = 50\Omega$, $V_{OUT} = 4V_{P-P}$
t _r , t _f	Rise Time Fall Time	1.2	1.5	1.7	1.8	ns	$R_L = 50\Omega$, $C_L \leq 10pF$ $V_O = 100mV_{PP}$
t _{pd}	Propagation Delay Time	2.0				ns	$R_L = 50\Omega$, $C_L \leq 10pF$ $V_O = 100mV_{PP}$
O _S	Overshoot	10				%	$R_L = 50\Omega$, $C_L \leq 10pF$ $V_O = 100mV_{PP}$

Note 1: Absolute Maximum Ratings indicate limits beyond which damage to the device may occur. DC and AC electrical specifications do not apply when operating the device beyond its rated operating conditions.

Note 2: Slew rate is measured with 50Ω source impedance at $25^\circ C$. For accurate measurements, the input slew rate should be at least $5000V/\mu s$.

Note 3: The test circuit consists of the human body model of $120pF$ in series with 1500Ω .

Note 4: The maximum power dissipation is a function of $T_{J(max)}$, θ_{JA} and T_A . The maximum allowable power dissipation at any ambient temperature is $P_D = (T_{J(max)} - T_A)/\theta_{JA}$.

Note 5: Limits are guaranteed by testing, correlation or periodic characterization.

Note 6: For N package, θ_{JA} is measured by soldering the unit directly on a printed circuit board and V⁻ pins are connected to 2 square inches of 2 oz copper.

TYPICAL PERFORMANCE CHARACTERISTICS

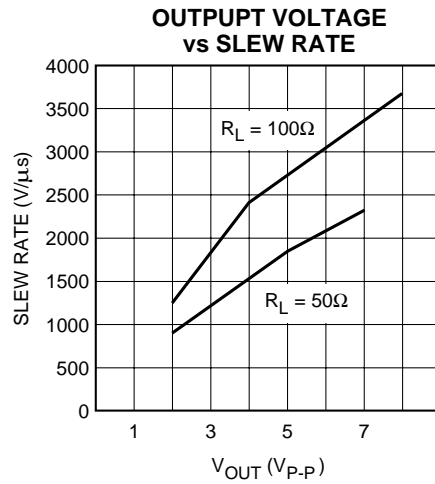
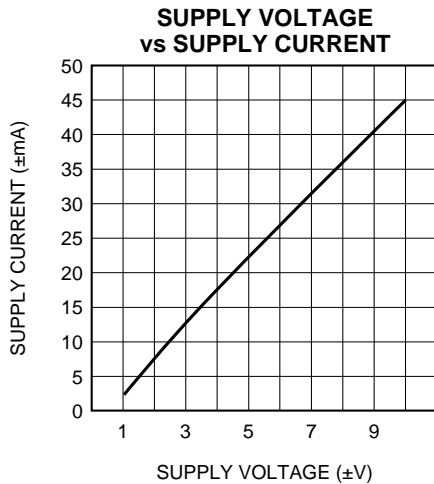
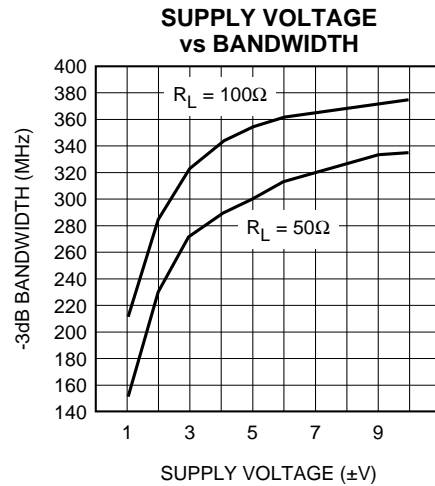
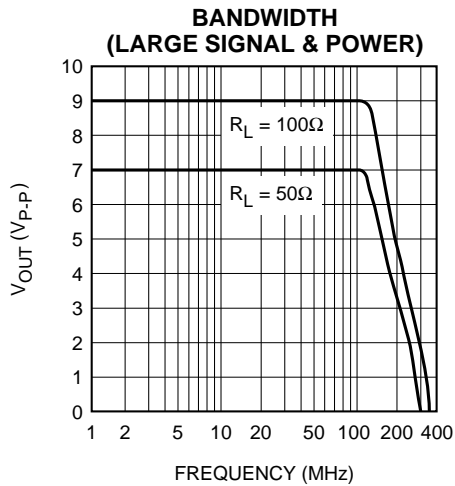
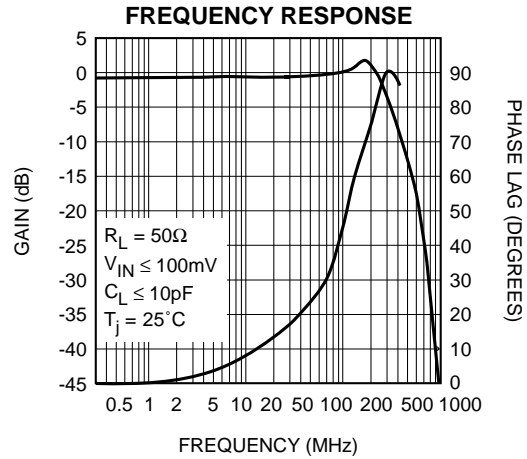
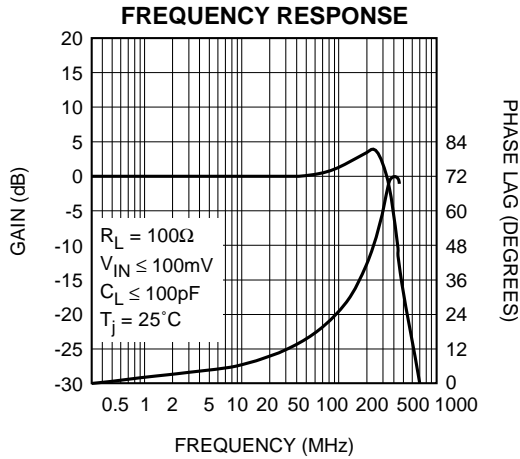

Wideband Unity Gain Amplifier

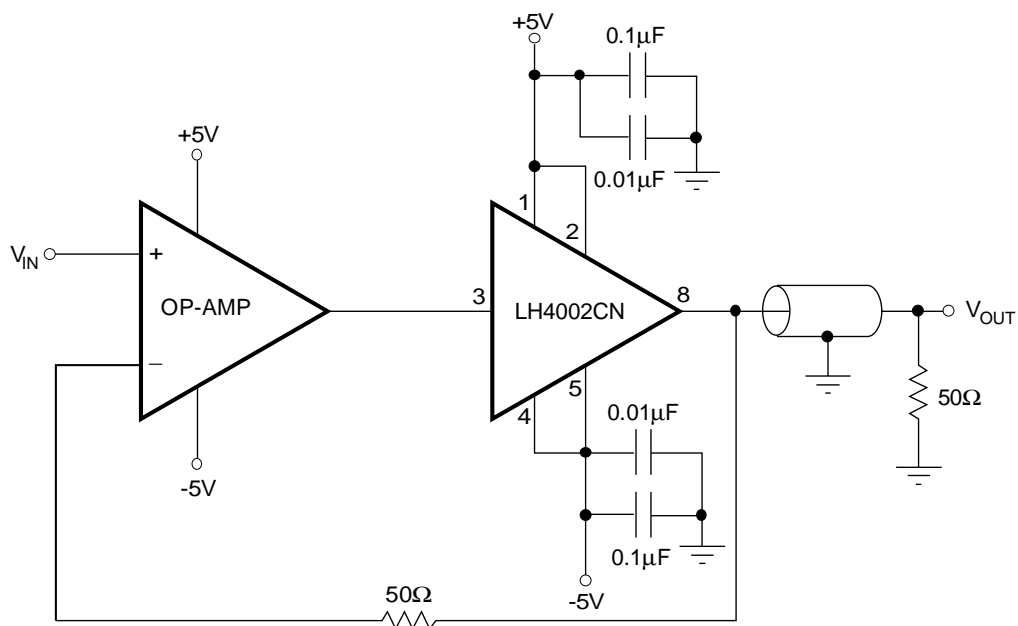

Short Circuit Protection

