

International  
**IR** Rectifier

# IRF7353D1

**FETKY™** MOSFET / Schottky Diode

- Co-packaged HEXFET® Power MOSFET and Schottky Diode
- Ideal For Buck Regulator Applications
- N-Channel HEXFET
- Low  $V_F$  Schottky Rectifier
- Generation 5 Technology
- SO-8 Footprint

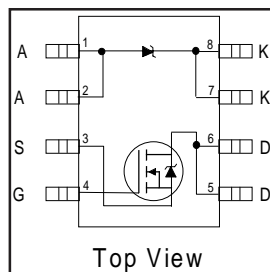

$V_{DSS} = 30V$
$R_{DS(on)} = 0.029\Omega$
Schottky $V_f = 0.39V$

## Description

The **FETKY** family of co-packaged MOSFETs and Schottky diodes offers the designer an innovative, board space saving solution for switching regulator and power management applications. Generation 5 HEXFET Power MOSFETs utilize advanced processing techniques to achieve extremely low on-resistance per silicon area. Combining this technology with International Rectifier's low forward drop Schottky rectifiers results in an extremely efficient device suitable for use in a wide variety of portable electronics applications.

The SO-8 has been modified through a customized leadframe for enhanced thermal characteristics. The SO-8 package is designed for vapor phase, infrared or wave soldering techniques.

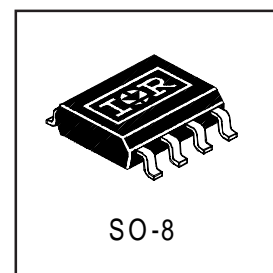

## Absolute Maximum Ratings ( $T_A = 25^\circ C$ unless otherwise noted)

Parameter		Maximum	Units
$I_D @ T_A = 25^\circ C$	Continuous Drain Current ④	6.5	A
$I_D @ T_A = 70^\circ C$		5.2	
$I_{DM}$	Pulsed Drain Current ①	52	
$P_D @ T_A = 25^\circ C$	Power Dissipation ④	2.0	W
$P_D @ T_A = 70^\circ C$		1.3	
	Linear Derating Factor	16	mW/°C
$V_{GS}$	Gate-to-Source Voltage	$\pm 20$	V
$dv/dt$	Peak Diode Recovery $dv/dt$ ②	-5.0	V/ns
$T_J, T_{STG}$	Junction and Storage Temperature Range	-55 to +150	°C

## Thermal Resistance Ratings

Parameter		Maximum	Units
$R_{\theta JA}$	Junction-to-Ambient ⑤	62.5	°C/W

### Notes:

① Repetitive rating; pulse width limited by maximum junction temperature (see figure 9)

② Starting  $T_J = 25^\circ C$ ,  $L = 10mH$ ,  $R_G = 25\Omega$ ,  $I_{AS} = 4.0A$

③  $I_{SD} \leq 4.0A$ ,  $di/dt \leq 74A/\mu s$ ,  $V_{DD} \leq V_{(BR)DSS}$ ,  $T_J \leq 150^\circ C$

④ Pulse width  $\leq 300\mu s$ ; duty cycle  $\leq 2\%$

⑤ Surface mounted on FR-4 board,  $t \leq 10sec$ .

www.irf.com

1

**MOSFET Electrical Characteristics @ T<sub>J</sub> = 25°C (unless otherwise specified)**

Parameter		Min.	Typ.	Max.	Units	Conditions
V <sub>(BR)DSS</sub>	Drain-to-Source Breakdown Voltage	30	—	—	V	V <sub>GS</sub> = 0V, I <sub>D</sub> = 250μA
R <sub>DS(on)</sub>	Static Drain-to-Source On-Resistance	—	0.023	0.032	Ω	V <sub>GS</sub> = 10V, I <sub>D</sub> = 5.8A ④
		—	0.032	0.046		V <sub>GS</sub> = 4.5V, I <sub>D</sub> = 4.7A ④
V <sub>GS(th)</sub>	Gate Threshold Voltage	1.0	—	—	V	V <sub>DS</sub> = V <sub>GS</sub> , I <sub>D</sub> = 250μA
g <sub>fs</sub>	Forward Transconductance	—	14	—	S	V <sub>DS</sub> = 24V, I <sub>D</sub> = 5.8A
I <sub>DSS</sub>	Drain-to-Source Leakage Current	—	—	1.0	μA	V <sub>DS</sub> = 24V, V <sub>GS</sub> = 0V
		—	—	25		V <sub>DS</sub> = 24V, V <sub>GS</sub> = 0V, T <sub>J</sub> = 55°C
I <sub>GSS</sub>	Gate-to-Source Forward Leakage	—	—	100	nA	V <sub>GS</sub> = 20V
	Gate-to-Source Reverse Leakage	—	—	-100		V <sub>GS</sub> = -20V
Q <sub>g</sub>	Total Gate Charge	—	22	33	nC	I <sub>D</sub> = 5.8A
Q <sub>gs</sub>	Gate-to-Source Charge	—	2.6	3.9		V <sub>DS</sub> = 24V
Q <sub>gd</sub>	Gate-to-Drain ("Miller") Charge	—	6.4	9.6		V <sub>GS</sub> = 10V (see figure 8) ④
t <sub>d(on)</sub>	Turn-On Delay Time	—	8.1	12		V <sub>DD</sub> = 15V
t <sub>r</sub>	Rise Time	—	8.9	13	ns	I <sub>D</sub> = 1.0A
t <sub>d(off)</sub>	Turn-Off Delay Time	—	26	39		R <sub>G</sub> = 6.0Ω
t <sub>f</sub>	Fall Time	—	17	26		R <sub>D</sub> = 15Ω ④
C <sub>iss</sub>	Input Capacitance	—	650	—		pF
C <sub>oss</sub>	Output Capacitance	—	320	—	V <sub>DS</sub> = 25V	
C <sub>rss</sub>	Reverse Transfer Capacitance	—	130	—	f = 1.0MHz (see figure 7)	

**MOSFET Source-Drain Ratings and Characteristics**

Parameter		Min.	Typ.	Max.	Units	Conditions
I <sub>S</sub>	Continuous Source Current (Body Diode)	—	—	2.5	A	
I <sub>SM</sub>	Pulsed Source Current (Body Diode)	—	—	30		
V <sub>SD</sub>	Body Diode Forward Voltage	—	0.78	1.0	V	T <sub>J</sub> = 25°C, I <sub>S</sub> = 1.7A, V <sub>GS</sub> = 0V
t <sub>rr</sub>	Reverse Recovery Time (Body Diode)	—	45	68	ns	T <sub>J</sub> = 25°C, I <sub>F</sub> = 1.7A
Q <sub>rr</sub>	Reverse Recovery Charge	—	58	87	nC	di/dt = 100A/μs ③

**Schottky Diode Maximum Ratings**

	Parameter	Max.	Units	Conditions
I <sub>F(av)</sub>	Max. Average Forward Current	2.7	A	50% Duty Cycle. Rectangular Wave, T <sub>A</sub> = 25°C
		1.9		See Fig. 14 T <sub>A</sub> = 70°C
I <sub>SM</sub>	Max. peak one cycle Non-repetitive Surge current	120	A	5μs sine or 3μs Rect. pulse
		11		10ms sine or 6ms Rect. pulse
				Following any rated load condition & with V <sub>RRM</sub> applied

**Schottky Diode Electrical Specifications**

	Parameter	Max.	Units	Conditions
V <sub>FM</sub>	Max. Forward voltage drop	0.50	V	I <sub>F</sub> = 1.0A, T <sub>J</sub> = 25°C
		0.62		I <sub>F</sub> = 2.0A, T <sub>J</sub> = 25°C
		0.39		I <sub>F</sub> = 1.0A, T <sub>J</sub> = 125°C
		0.57		I <sub>F</sub> = 2.0A, T <sub>J</sub> = 125°C .
I <sub>RM</sub>	Max. Reverse Leakage current	0.06	mA	V <sub>R</sub> = 30V, T <sub>J</sub> = 25°C
		16		T <sub>J</sub> = 125°C
C <sub>t</sub>	Max. Junction Capacitance	92	pF	V <sub>R</sub> = 5Vdc ( 100kHz to 1 MHz) 25°C
dv/dt	Max. Voltage Rate of Charge	3600	V/ μs	Rated V <sub>R</sub>

Power Mosfet Characteristics

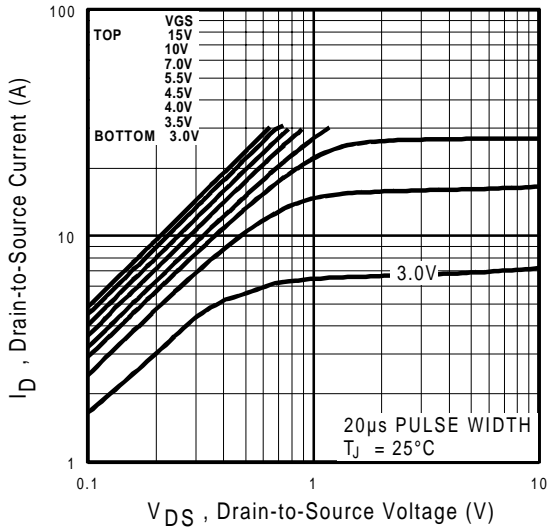

Fig 1. Typical Output Characteristics

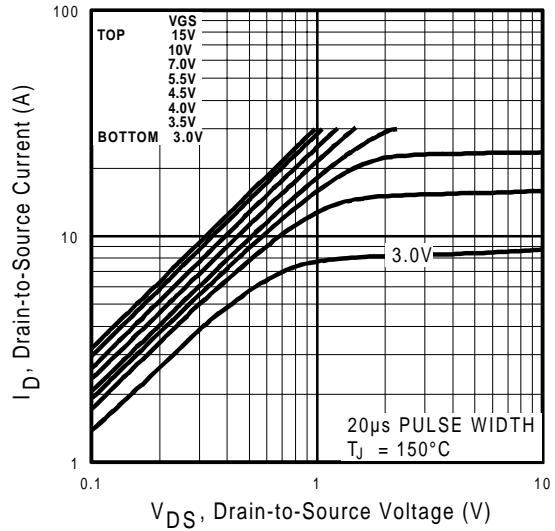

Fig 2. Typical Output Characteristics

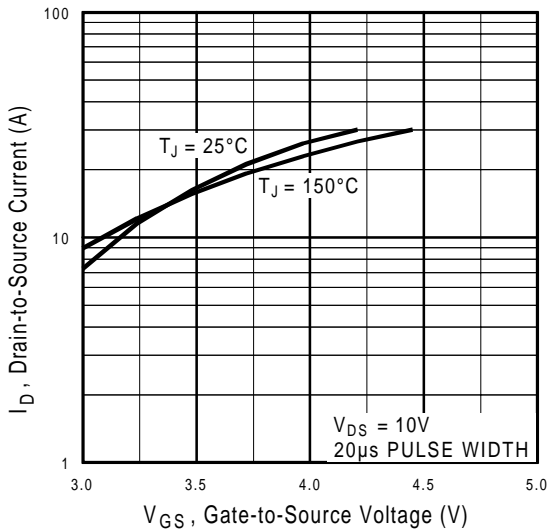

Fig 3. Typical Transfer Characteristics

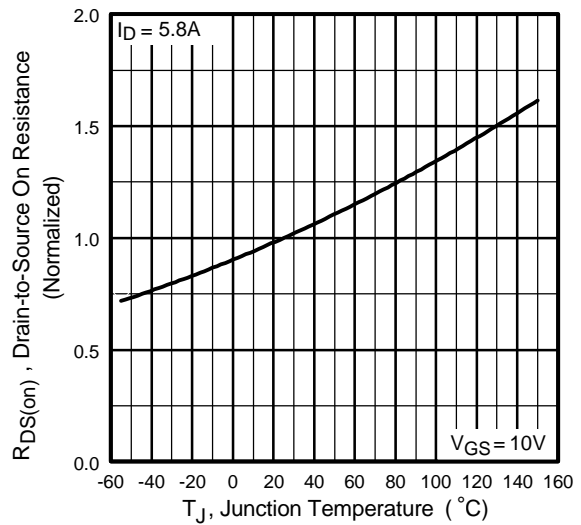

Fig 4. Normalized On-Resistance Vs. Temperature

Power Mosfet Characteristics

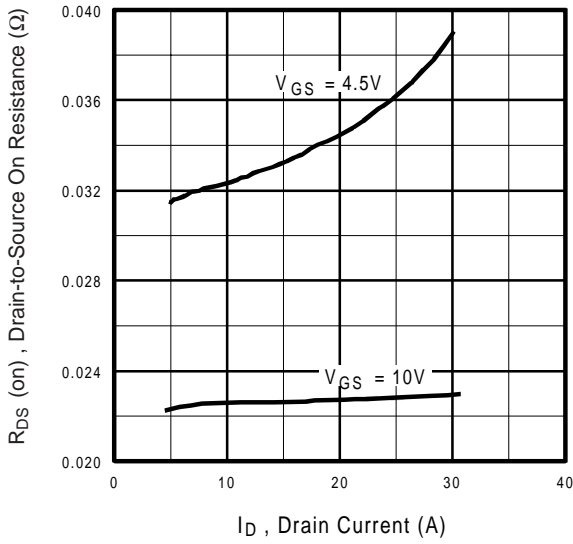

Fig 5. Typical On-Resistance Vs. Drain Current

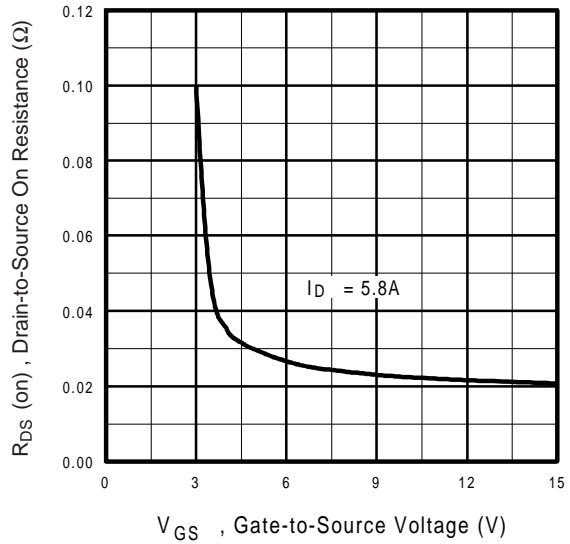

Fig 6. Typical On-Resistance Vs. Gate Voltage

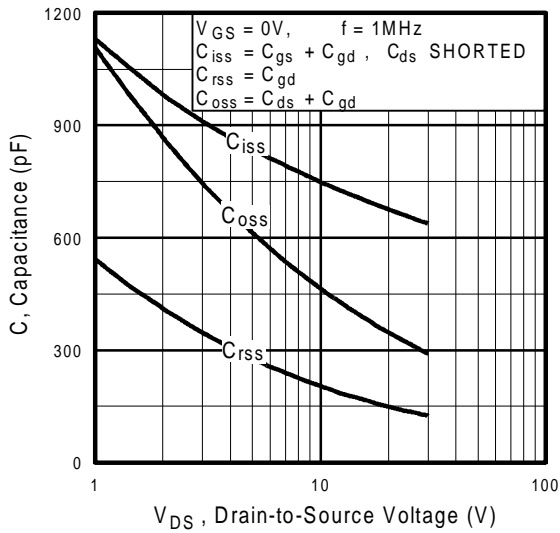

Fig 7. Typical Capacitance Vs. Drain-to-Source Voltage

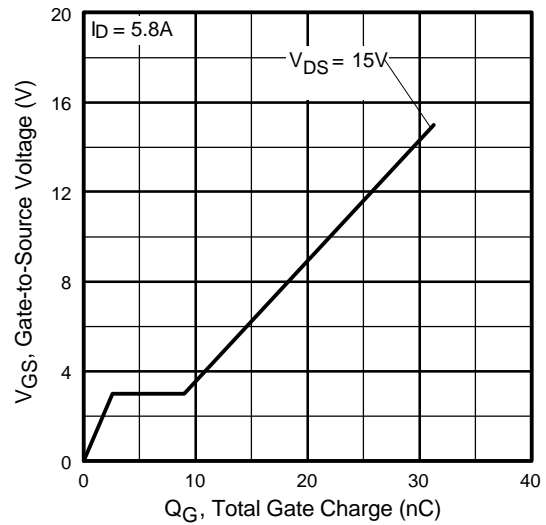

Fig 8. Typical Gate Charge Vs. Gate-to-Source Voltage

Power Mosfet Characteristics

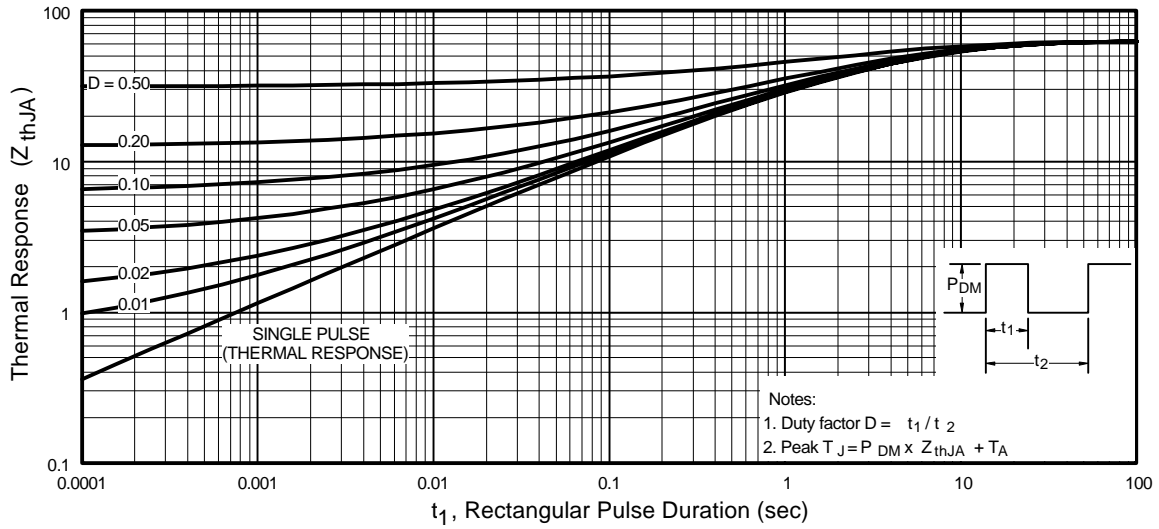

Fig 9. Maximum Effective Transient Thermal Impedance, Junction-to-Ambient

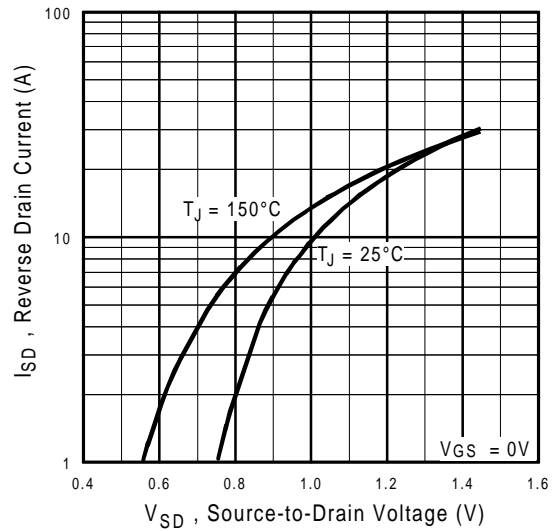

Fig 10. Typical Source-Drain Diode Forward Voltage

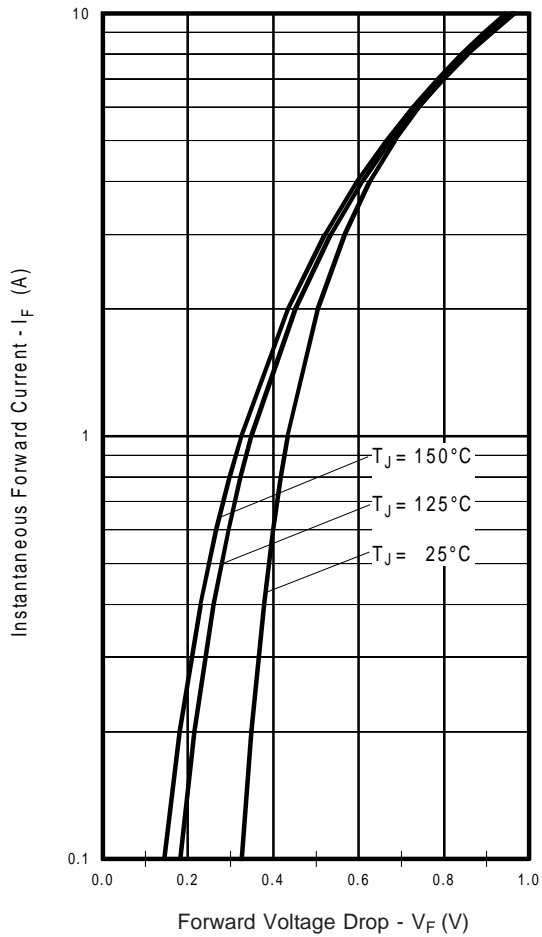

Fig. 12 - Typical Forward Voltage Drop Characteristics

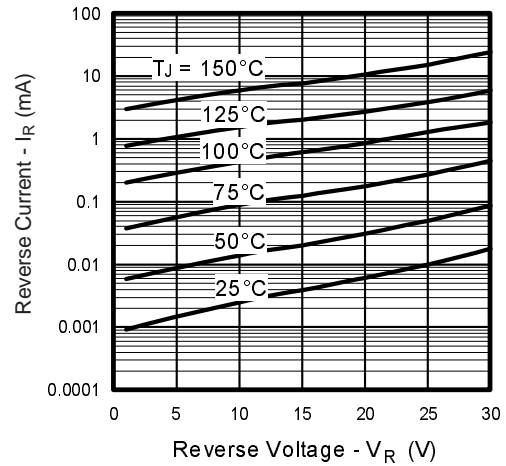

Fig. 13 - Typical Values of Reverse Current Vs. Reverse Voltage

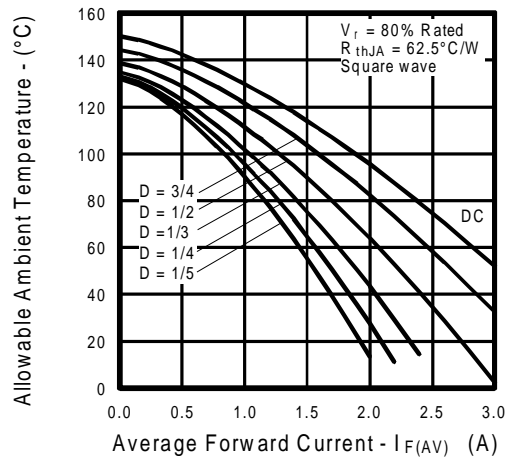
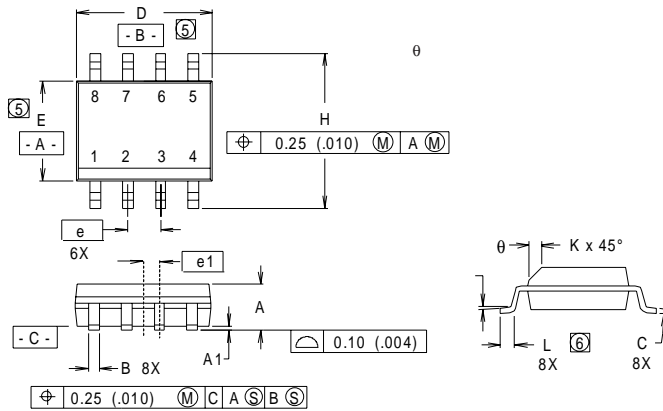

Fig.14 - Maximum Allowable Ambient Temp. Vs. Forward Current

## SO-8 Package Details



DIM	INCHES		MILLIMETERS	
	MIN	MAX	MIN	MAX
A	.0532	.0688	1.35	1.75
A1	.0040	.0098	0.10	0.25
B	.014	.018	0.36	0.46
C	.0075	.0098	0.19	0.25
D	.189	.196	4.80	4.98
E	.150	.157	3.81	3.99
e	.050 BASIC		1.27 BASIC	
e1	.025 BASIC		0.635 BASIC	
H	.2284	.2440	5.80	6.20
K	.011	.019	0.28	0.48
L	0.16	.050	0.41	1.27
$\theta$	0°	8°	0°	8°

### RECOMMENDED FOOTPRINT

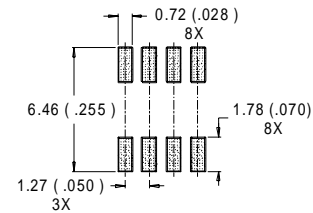

### NOTES:

1. DIMENSIONING AND TOLERANCING PER ANSI Y14.5M-1982.
2. CONTROLLING DIMENSION : INCH.
3. DIMENSIONS ARE SHOWN IN MILLIMETERS (INCHES).
4. OUTLINE CONFORMS TO JEDEC OUTLINE MS-012AA.
5. DIMENSION DOES NOT INCLUDE MOLD PROTRUSIONS  
MOLD PROTRUSIONS NOT TO EXCEED 0.25 (.006).
6. DIMENSIONS IS THE LENGTH OF LEAD FOR SOLDERING TO A SUBSTRATE..

## Part Marking

EXAMPLE: THIS IS AN IRF7101

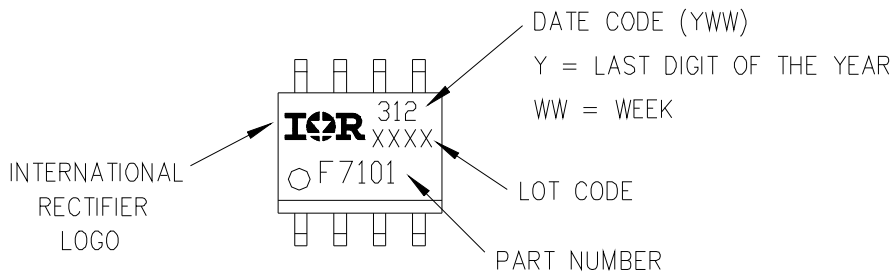

# IRF7353D1

International  
**IR** Rectifier

## Tape and Reel

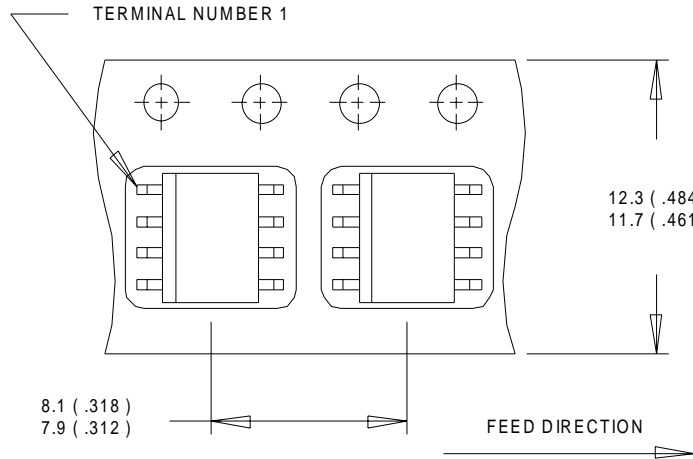

### NOTES:

1. CONTROLLING DIMENSION : MILLIMETER.
2. ALL DIMENSIONS ARE SHOWN IN MILLIMETERS(INCHES).
3. OUTLINE CONFORMS TO EIA-481 & EIA-541.

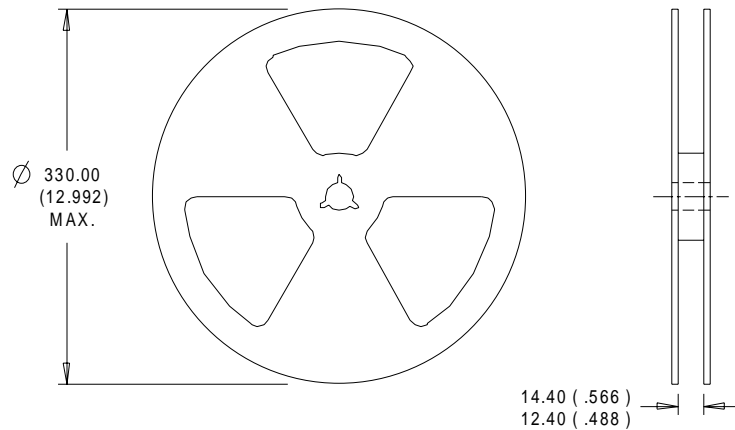

### NOTES :

1. CONTROLLING DIMENSION : MILLIMETER.
2. OUTLINE CONFORMS TO EIA-481 & EIA-541.

International  
**IR** Rectifier

**WORLD HEADQUARTERS:** 233 Kansas St., El Segundo, California 90245, Tel: (310) 322 3331

**IR GREAT BRITAIN:** Hurst Green, Oxted, Surrey RH8 9BB, UK Tel: ++ 44 1883 732020

**IR CANADA:** 15 Lincoln Court, Brampton, Ontario L6T3Z2, Tel: (905) 453 2200

**IR GERMANY:** Saalburgstrasse 157, 61350 Bad Homburg Tel: ++ 49 6172 96590

**IR ITALY:** Via Liguria 49, 10071 Borgaro, Torino Tel: ++ 39 11 451 0111

**IR FAR EAST:** K&H Bldg., 2F, 30-4 Nishi-Ikebukuro 3-Chome, Toshima-Ku, Tokyo Japan 171 Tel: 81 3 3983 0086

**IR SOUTHEAST ASIA:** 1 Kim Seng Promenade, Great World City West Tower, 13-11, Singapore 237994 Tel: ++ 65 838 4630

**IR TAIWAN:** 16 Fl. Suite D. 207, Sec. 2, Tun Haw South Road, Taipei, 10673, Taiwan Tel: 886-2-2377-9936

<http://www.irf.com/>

Data and specifications subject to change without notice. 3/99

[www.irf.com](http://www.irf.com)