

TD62003PA, TD62003APA, TD62004PA, TD62004APA

7CH DARLINGTON SINK DRIVER

The TD62003PA / APA Series are high-voltage, high-current darlington drivers comprised of seven NPN darlington pairs. All units feature integral clamp diodes for switching inductive loads.

Applications include relay, hammer, lamp and display (LED) drivers.

FEATURES

- Output current (single output) 500mA (Max.)
- High sustaining voltage output
 35V (Min.) (TD62003PA series)
 50V (Min.) (TD62003APA series)
- Output clamp diodes
- Inputs compatible with various types of logic.
 TD62003PA, APA $R_{IN} = 2.7k\Omega$
 TD62004PA, APA $R_{IN} = 10.5k\Omega$
- Package DIP-16pin

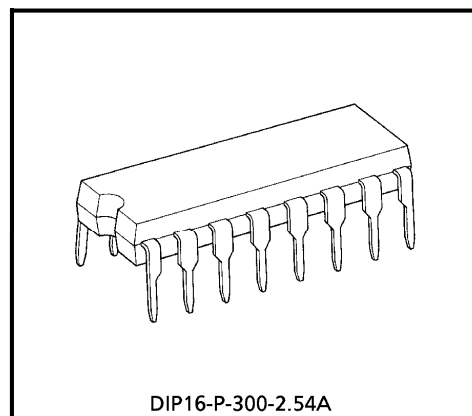

Weight : 1.11g (Typ.)

PIN CONNECTION (TOP VIEW)

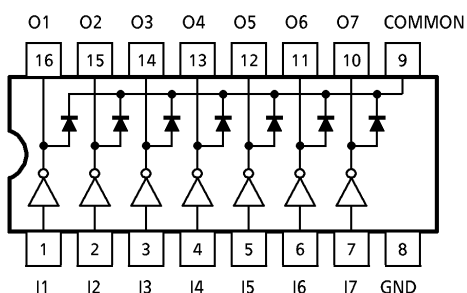

961001EBA2

● TOSHIBA is continually working to improve the quality and the reliability of its products. Nevertheless, semiconductor devices in general can malfunction or fail due to their inherent electrical sensitivity and vulnerability to physical stress. It is the responsibility of the buyer, when utilizing TOSHIBA products, to observe standards of safety, and to avoid situations in which a malfunction or failure of a TOSHIBA product could cause loss of human life, bodily injury or damage to property. In developing your designs, please ensure that TOSHIBA products are used within specified operating ranges as set forth in the most recent products specifications. Also, please keep in mind the precautions and conditions set forth in the TOSHIBA Semiconductor Reliability Handbook.

● The products described in this document are subject to foreign exchange and foreign trade control laws.

● The information contained herein is presented only as a guide for the applications of our products. No responsibility is assumed by TOSHIBA CORPORATION for any infringements of intellectual property or other rights of the third parties which may result from its use. No license is granted by implication or otherwise under any intellectual property or other rights of TOSHIBA CORPORATION or others.

● The information contained herein is subject to change without notice.

SCHEMATICS (EACH DRIVER)

TD62003PA / APA

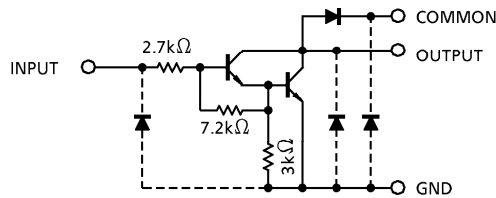

TD62004PA / APA

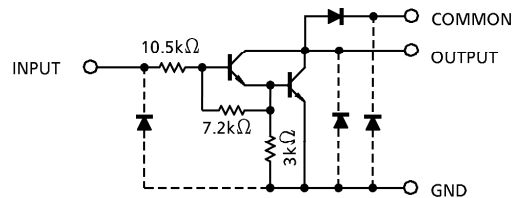

(Note) The input and output parasitic diodes cannot be used as clamp diodes.

MAXIMUM RATINGS (Ta = 25°C)

CHARACTERISTIC		SYMBOL	RATING	UNIT
Output Sustaining Voltage	PA	V _{CE (SUS)}	- 0.5~35	V
	APA		- 0.5~50	
Output Current		I _{OUT}	500	mA / ch
Input Voltage		V _{IN}	- 0.5~30	V
Clamp Diode Reverse Voltage	PA	V _R	35	V
	APA		50	
Clamp Diode Forward Current		I _F	500	mA
Power Dissipation		P _D	1.47	W
Operating Temperature	PA	T _{opr}	- 30~75	°C
	APA		- 40~85	
Storage Temperature		T _{stg}	- 55~150	°C

RECOMMENDED OPERATING CONDITIONS

(Ta = - 40~85°C for Type-APA and Ta = - 30~75°C for Type-PA)

CHARACTERISTIC		SYMBOL	CONDITION	MIN.	TYP.	MAX.	UNIT	
Output Sustaining Voltage	PA	V _{CE (SUS)}		0	—	35	V	
	APA			0	—	50		
Output Current	PA	I _{OUT}	T _{pw} = 25ms 7 Circuits	Duty = 10%	0	—	370	mA / ch
				Duty = 50%	0	—	140	
	APA			Duty = 10%	0	—	400	
				Duty = 50%	0	—	170	
Input Voltage	TD62003	V _{IN}		0	—	24	V	
		V _{IN (ON)}	I _{OUT} = 400mA, h _{FE} = 800	2.8	—	24		
	TD62004	V _{IN (ON)}		6.2	—	24	V	
		V _{IN (OFF)}		0	—	0.7		
Clamp Diode Reverse Voltage	PA	V _R		—	—	35	V	
	APA			—	—	50		
Clamp Diode Forward Current		I _F		—	—	350	mA	
Power Dissipation		P _D	Ta = 85°C	—	—	0.52	W	

ELECTRICAL CHARACTERISTICS (Ta = 25°C)

CHARACTERISTIC		SYMBOL	TEST CIR-CUIT	TEST CONDITION	MIN.	TYP.	MAX.	UNIT	
Output Leakage Current	APA	I _{CEX}	1	V _{CE} = 50V, Ta = 25°C	—	—	50	μA	
	PA			V _{CE} = 50V, Ta = 85°C	—	—	100		
				V _{CE} = 35V, Ta = 25°C	—	—	50		
	V _{CE} = 35V, Ta = 75°C			—	—	100			
Collector-Emitter Saturation Voltage		V _{CE (sat)}	2	I _{OUT} = 350mA, I _{IN} = 500μA	—	1.3	1.6	V	
				I _{OUT} = 200mA, I _{IN} = 350μA	—	1.1	1.3		
				I _{OUT} = 100mA, I _{IN} = 250μA	—	0.9	1.1		
DC Current Transfer Ratio		h _{FE}	2	V _{CE} = 2V, I _{OUT} = 350mA	1000	—	—		
Input Current (Output On)	TD62003	I _{IN (ON)}	3	V _{IN} = 2.4V, I _{OUT} = 350mA	—	0.4	0.7	mA	
	TD62004			V _{IN} = 9.5V, I _{OUT} = 350mA	—	0.8	1.3		
	PA	I _{IN (OFF)}	4	I _{OUT} = 500μA, Ta = 75°C	50	65	—	μA	
	APA			I _{OUT} = 500μA, Ta = 85°C	50	65	—		
Input Voltage (Output On)	TD62003	V _{IN (ON)}	5	V _{CE} = 2V h _{FE} = 800	I _{OUT} = 350mA	—	—	2.6	V
					I _{OUT} = 200mA	—	—	2.0	
	TD62004				I _{OUT} = 350mA	—	—	4.7	
					I _{OUT} = 200mA	—	—	4.4	
Clamp Diode Reverse Current	APA	I _R	6	V _R = 50V, Ta = 25°C	—	—	50	μA	
	PA			V _R = 50V, Ta = 85°C	—	—	100		
				V _R = 35V, Ta = 25°C	—	—	50		
				V _R = 35V, Ta = 75°C	—	—	100		
Clamp Diode Forward Voltage		V _F	7	I _F = 350mA	—	—	2.0	V	
Input Capacitance		C _{IN}	—		—	15	—	pF	
Turn-on Delay	PA	t _{ON}	8	V _{OUT} = 35V, R _L = 85Ω C _L = 15pF	—	0.1	—	μs	
	APA			V _{OUT} = 50V, R _L = 125Ω C _L = 15pF	—	0.1	—		
Turn-Off Delay	PA	t _{OFF}	8	V _{OUT} = 35V, R _L = 85Ω C _L = 15pF	—	0.2	—		
	APA			V _{OUT} = 50V, R _L = 125Ω C _L = 15pF	—	0.2	—		

TEST CIRCUIT

1. I_{CEX}

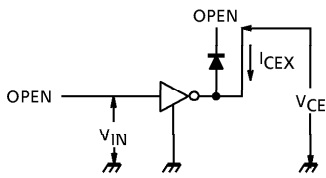

2. $V_{CE(sat)}$, h_{FE}

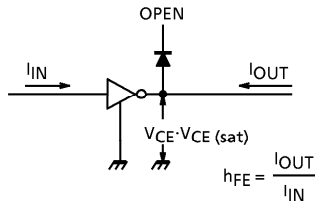

3. $I_{IN(ON)}$

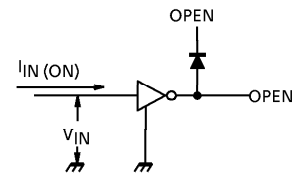

4. $I_{IN(OFF)}$

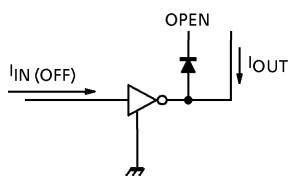

5. $V_{IN(ON)}$

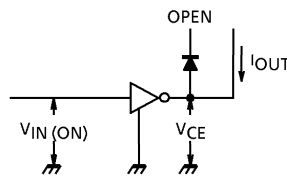

6. I_R

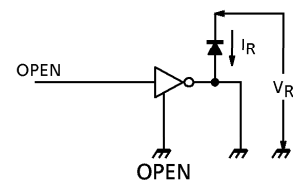

7. V_F

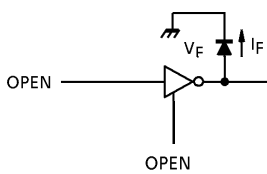

8. t_{ON} , t_{OFF}

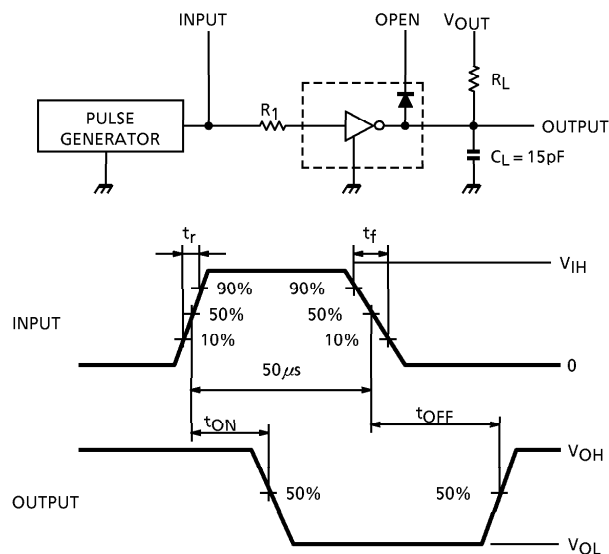

(Note 1) Pulse Width $50\mu s$, Duty Cycle 10%
Output Impedance 50Ω , $t_r \leq 5ns$, $t_f \leq 10ns$

(Note 2) See below

INPUT CONDITION

TYPE NUMBER	R_1	V_{IH}
TD62003PA / APA	0	3V
TD62004PA / APA	0	8V

(Note 3) C_L includes probe and jig capacitance

PRECAUTIONS for USING

Utmost care is necessary in the design of the output line, COMMON and GND line since IC may be destroyed due to short-circuit between outputs, air contamination fault, or fault by improper grounding.

