

Cascadable Silicon Bipolar MMIC Amplifier

Technical Data

MSA-0870

Features

- **Usable Gain to 6.0 GHz**
- **High Gain:**
32.5 dB Typical at 0.1 GHz
23.5 dB Typical at 1.0 GHz
- **Low Noise Figure:**
3.0 dB Typical at 1.0 GHz
- **Hermetic Gold-ceramic
Microstrip Package**

Description

The MSA-0870 is a high performance silicon bipolar Monolithic Microwave Integrated Circuit (MMIC) housed in a hermetic, high reliability package. This MMIC is designed for use as a general

purpose 50 Ω gain block above 0.5 GHz and can be used as a high gain transistor below this frequency. Typical applications include narrow and moderate band IF and RF amplifiers in industrial and military applications.

The MSA-series is fabricated using HP's 10 GHz f_T , 25 GHz f_{MAX} , silicon bipolar MMIC process which uses nitride self-alignment, ion implantation, and gold metallization to achieve excellent performance, uniformity and reliability. The use of an external bias resistor for temperature and current stability also allows bias flexibility.

70 mil Package

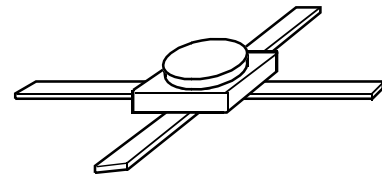

Typical Biasing Configuration

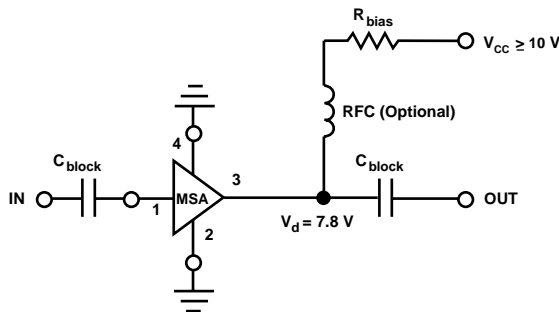

MSA-0870 Absolute Maximum Ratings

Parameter	Absolute Maximum ^[1]
Device Current	80 mA
Power Dissipation ^[2,3]	750 mW
RF Input Power	+13 dBm
Junction Temperature	200°C
Storage Temperature	-65°C to 200°C

Thermal Resistance^[2,4]:

$$\theta_{jc} = 150^{\circ}\text{C}/\text{W}$$

Notes:

1. Permanent damage may occur if any of these limits are exceeded.
2. $T_{\text{CASE}} = 25^{\circ}\text{C}$.
3. Derate at 6.7 mW/°C for $T_{\text{C}} > 88^{\circ}\text{C}$.
4. The small spot size of this technique results in a higher, though more accurate determination of θ_{jc} than do alternate methods. See MEASUREMENTS section “Thermal Resistance” for more information.

Electrical Specifications^[1], $T_{\text{A}} = 25^{\circ}\text{C}$

Symbol	Parameters and Test Conditions: $I_{\text{d}} = 36 \text{ mA}$, $Z_{\text{o}} = 50 \Omega$	Units	Min.	Typ.	Max.
G _P	Power Gain ($ S_{21} ^2$)	dB	22.0	f = 0.1 GHz	32.5
				f = 1.0 GHz	23.5
				f = 4.0 GHz	11.0
VSWR	Input VSWR			2.0:1	
	Output VSWR			1.9:1	
NF	50 Ω Noise Figure	dB		3.0	
P _{1 dB}	Output Power at 1 dB Gain Compression	dBm		12.5	
IP ₃	Third Order Intercept Point	dBm		27.0	
t _D	Group Delay	psec		125	
V _d	Device Voltage	V	7.0	7.8	8.4
dV/dT	Device Voltage Temperature Coefficient	mV/°C		-17.0	

Note:

1. The recommended operating current range for this device is 20 to 40 mA. Typical performance as a function of current is on the following page.

MSA-0870 Typical Scattering Parameters^[1] ($Z_0 = 50 \Omega$, $T_A = 25^\circ\text{C}$, $I_d = 36 \text{ mA}$)

Freq. GHz	S ₁₁		S ₂₁			S ₁₂			S ₂₂		k
	Mag	Ang	dB	Mag	Ang	dB	Mag	Ang	Mag	Ang	
0.1	.65	-19	32.5	42.04	161	-36.3	.015	40	.64	-22	0.78
0.2	.60	-35	31.5	37.54	145	-33.7	.021	47	.58	-43	0.66
0.4	.48	-60	29.1	28.49	122	-30.5	.030	51	.47	-74	0.64
0.6	.40	-76	26.8	21.90	108	-28.0	.040	50	.38	-97	0.72
0.8	.35	-88	24.9	17.48	97	-26.2	.049	50	.33	-113	0.78
1.0	.32	-102	23.4	14.85	87	-24.9	.057	51	.28	-128	0.83
1.5	.29	-118	20.1	10.14	70	-23.0	.071	47	.22	-151	0.91
2.0	.30	-133	17.6	7.55	56	-21.9	.081	45	.16	-167	0.98
2.5	.31	-139	15.6	6.01	49	-20.0	.100	46	.12	-172	1.02
3.0	.32	-149	13.8	4.87	39	-19.5	.106	41	.07	-170	1.11
3.5	.34	-159	12.2	4.09	28	-18.4	.121	35	.07	-143	1.12
4.0	.34	-168	10.8	3.48	17	-17.7	.131	31	.12	-112	1.16
5.0	.33	161	8.4	2.63	-3	-16.6	.147	21	.19	-103	1.26
6.0	.39	128	6.2	2.04	-22	-16.2	.155	10	.21	-115	1.36

Note:

1. A model for this device is available in the DEVICE MODELS section.

Typical Performance, $T_A = 25^\circ\text{C}$

(unless otherwise noted)

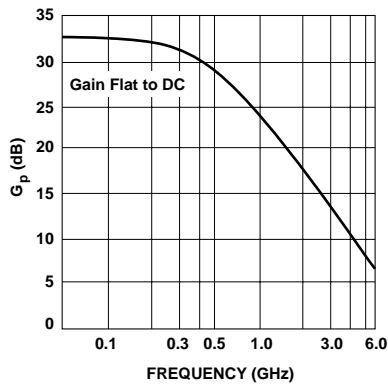

Figure 1. Typical Power Gain vs. Frequency, $I_d = 36 \text{ mA}$.

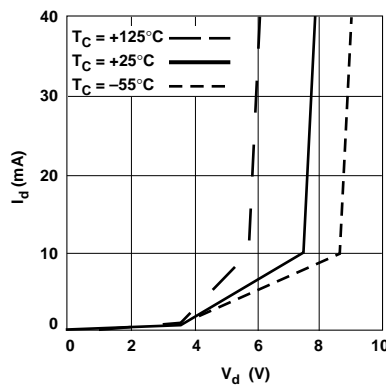

Figure 2. Device Current vs. Voltage.

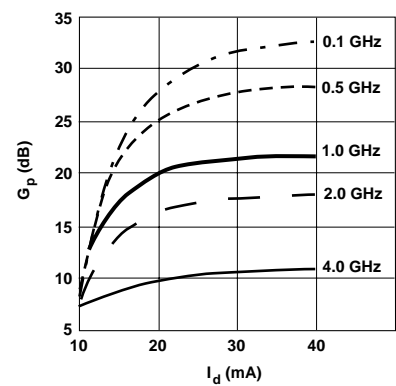

Figure 3. Power Gain vs. Current.

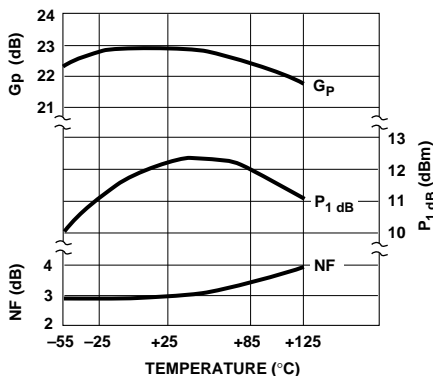

Figure 4. Output Power at 1 dB Gain Compression, NF and Power Gain vs. Case Temperature, $f = 1.0 \text{ GHz}$, $I_d = 36 \text{ mA}$.

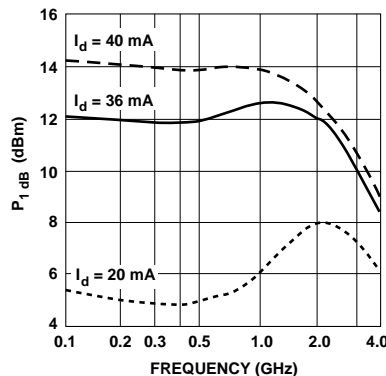

Figure 5. Output Power at 1 dB Gain Compression vs. Frequency.

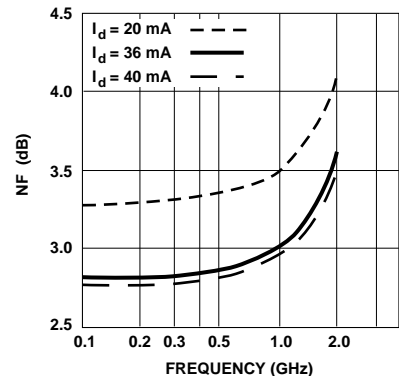

Figure 6. Noise Figure vs. Frequency.

70 mil Package Dimensions

