

EVALUATION KIT MANUAL  
FOLLOWS DATA SHEET

# MAXIM

## 375MHz Quad Closed-Loop Video Buffers, $A_v = +1$ and $+2$

### General Description

The MAX496 and MAX497 are quad, closed-loop,  $\pm 5V$  video buffers that feature extremely high bandwidth and slew rate for both component video (RGB or YUV) and composite video (NTSC, PAL, SECAM). The MAX496 is a unity-gain (0dB) buffer with a 375MHz -3dB bandwidth and a 1600V/ $\mu$ s slew rate. The MAX497 gain of +2 (6dB) buffer, optimized for driving back-terminated coaxial cable, features a 275MHz -3dB bandwidth and a 1500V/ $\mu$ s slew rate. The MAX496/MAX497 are not slew-rate limited, thus providing a high full-power bandwidth of 230MHz and 215MHz, respectively.

The MAX496/MAX497 incorporate a unique two-stage architecture that combines the low offset and noise benefits of voltage feedback with the high bandwidth and slew-rate advantages of current-mode-feedback.

### Applications

Computer Workstations  
Surveillance Video  
Broadcast and High-Definition TV Systems  
Multimedia Products  
Medical Imaging  
High-Speed Signal Processing  
Video Switching and Routing

### Frequency Response

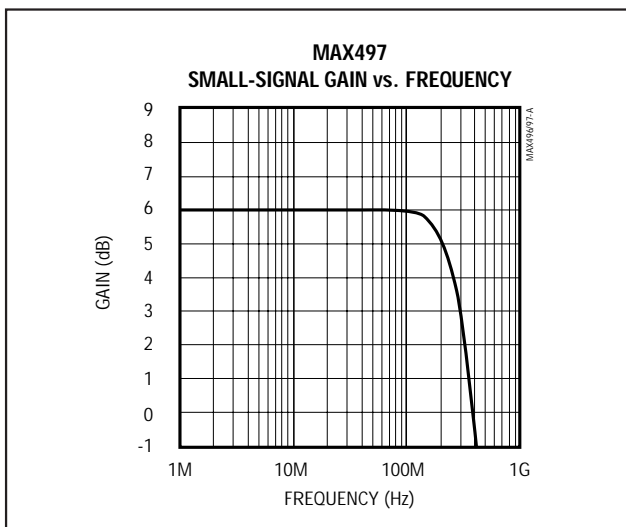

### Features

- ♦ **MAX496 Fixed Gain: +1V/V**  
**MAX497 Fixed Gain: +2V/V**
- ♦ **High Speed:**  
**Small-Signal -3dB Bandwidth: 375MHz (MAX496)**  
**275MHz (MAX497)**  
**Full-Power -3dB Bandwidth: 230MHz (MAX496)**  
**215MHz (MAX497)**
- ♦ **0.1dB Gain Flatness: 65MHz (MAX496)**  
**120MHz (MAX497)**
- ♦ **1600V/ $\mu$ s Slew Rate (MAX496)**  
**1500V/ $\mu$ s Slew Rate (MAX497)**
- ♦ **Fast Settling Time: 12ns to 0.1%**
- ♦ **Lowest Differential Phase/Gain Error: 0.01%/0.01%**
- ♦ **2pF Input Capacitance**
- ♦ **5.6nV/ $\sqrt{\text{Hz}}$  Input-Referred Voltage Noise**
- ♦ **Low Distortion: 64dBc (f = 10MHz)**
- ♦ **Directly Drives 50 $\Omega$  or 75 $\Omega$  Back-Terminated Cables**
- ♦ **High ESD Protection: 5000V**
- ♦ **Output Short-Circuit Protected**

### Ordering Information

PART	TEMP. RANGE	PIN-PACKAGE
<b>MAX496</b> CPE	0°C to +70°C	16 Plastic DIP
MAX496CSE	0°C to +70°C	16 Narrow SO
MAX496C/D	0°C to +70°C	Dice*
<b>MAX497</b> CPE	0°C to +70°C	16 Plastic DIP
MAX497CSE	0°C to +70°C	16 Narrow SO
MAX497C/D	0°C to +70°C	Dice*

\* Dice are specified at  $T_A = +25^\circ\text{C}$ , DC parameters only.

### Pin Configuration

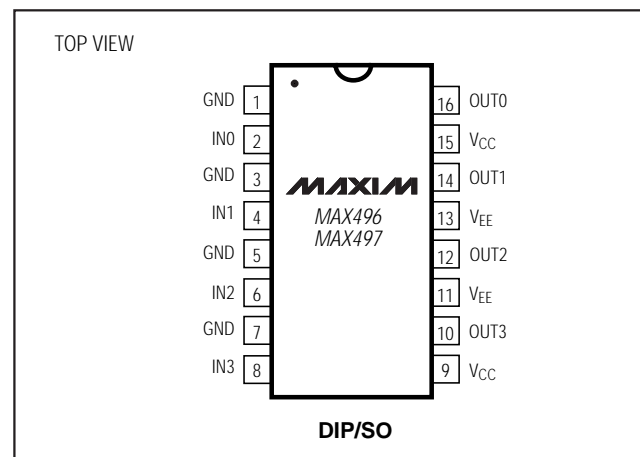

**MAXIM**

Maxim Integrated Products 1

For free samples & the latest literature: <http://www.maxim-ic.com>, or phone 1-800-998-8800.  
For small orders, phone 1-800-835-8769.

MAX496/MAX497

# 375MHz Quad Closed-Loop Video Buffers, $A_v = +1$ and $+2$

## ABSOLUTE MAXIMUM RATINGS

Supply Voltage ( $V_{CC}$  to  $V_{EE}$ ) ..... 12V  
 Voltage on Any Input Pin to GND ....( $V_{CC} + 0.3V$ ) to ( $V_{EE} - 0.3V$ )  
 Output Short-Circuit Current Duration .....60sec  
 Continuous Power Dissipation ( $T_A = +70^\circ\text{C}$ )  
   Plastic DIP (derate 10.53mW/ $^\circ\text{C}$  above  $+70^\circ\text{C}$ ) .....842mW  
   Narrow SO (derate 8.70mW/ $^\circ\text{C}$  above  $+70^\circ\text{C}$ ) .....696mW

Operating Temperature Range..... $0^\circ\text{C}$  to  $+70^\circ\text{C}$   
 Storage Temperature Range ..... $-65^\circ\text{C}$  to  $+150^\circ\text{C}$   
 Lead Temperature (soldering, 10sec) ..... $+300^\circ\text{C}$

Stresses beyond those listed under "Absolute Maximum Ratings" may cause permanent damage to the device. These are stress ratings only, and functional operation of the device at these or any other conditions beyond those indicated in the operational sections of the specifications is not implied. Exposure to absolute maximum rating conditions for extended periods may affect device reliability.

## DC ELECTRICAL CHARACTERISTICS

( $V_{CC} = +5V$ ,  $V_{EE} = -5V$ ,  $V_{IN} = 0V$ ,  $R_L = 150\Omega$ ,  $T_A = T_{MIN}$  to  $T_{MAX}$ , unless otherwise noted. Typical values are at  $T_A = +25^\circ\text{C}$ .)

PARAMETER	SYMBOL	CONDITIONS	MIN	TYP	MAX	UNITS
Input Voltage Range	$V_{IN}$	MAX496	$\pm 2.8$	$\pm 3.2$		V
		MAX497	$\pm 1.4$	$\pm 1.6$		
Input Offset Voltage	$V_{OS}$	$V_{OUT} = 0V$		$\pm 1$	$\pm 3$	mV
Input Offset Voltage Drift	$TCV_{OS}$	$V_{OUT} = 0V$		-10		$\mu\text{V}/^\circ\text{C}$
Input Bias Current	$I_B$	$V_{OUT} = 0V$		$\pm 1$	$\pm 5$	$\mu\text{A}$
Input Resistance	$R_{IN}$	MAX496: $-2V \leq V_{IN} \leq +2V$ , MAX497: $-1V \leq V_{IN} \leq +1V$	0.5	1.2		$\text{M}\Omega$
Input Capacitance	$C_{IN}$			2		pF
Voltage Gain	$A_v$	MAX496 (Note 1)	$R_L = 150\Omega$	0.988	1.00	V/V
			$R_L = 50\Omega$	0.983	1.00	
		MAX497 (Note 2)	$R_L = 150\Omega$	1.975	2.01	
			$R_L = 50\Omega$	1.965	2.01	
Positive Power-Supply Rejection Ratio (Change in $V_{OS}$ )	PSRR+	$V_{CC} = \pm 4.5V$ to $\pm 5.5V$ , $V_{EE} = -5.0V$	55	74		dB
Negative Power-Supply Rejection Ratio (Change in $V_{OS}$ )	PSRR-	$V_{EE} = \pm 4.5V$ to $\pm 5.5V$ , $V_{CC} = 5.0V$	60	78		dB
Gain Linearity	$AV_{LIN}$	$AV_{CL} = +2$ , $V_{OUT} = \pm 1\text{mV}$ to $\pm 2V$		0.01		%
Positive Quiescent Supply Current (Total)	$I_{SY+}$	$T_A = +25^\circ\text{C}$		31	36	mA
		$T_A = T_{MIN}$ to $T_{MAX}$			45	
Negative Quiescent Supply Current (Total)	$I_{SY-}$	$T_A = +25^\circ\text{C}$		32	37	mA
		$T_A = T_{MIN}$ to $T_{MAX}$			45	
Operating Supply Voltage Range	$V_S$		$\pm 4.50$		$\pm 5.50$	V
Output Voltage Swing	$V_{OUT}$	$R_L = 150\Omega$	$\pm 2.8$	$\pm 3.7$		V
		$R_L = 50\Omega$	$\pm 2.5$	$\pm 3.3$		
Output Resistance	$R_{OUT}$	DC		0.1		$\Omega$
Output Impedance	$Z_{OUT}$	$f = 10\text{MHz}$		1.5		$\Omega$
Short-Circuit Output Current	$I_{SC}$	Short to ground or either supply voltage		170		mA

# 375MHz Quad Closed-Loop Video Buffers, $A_v = +1$ and $+2$

MAX496/MAX497

## AC ELECTRICAL CHARACTERISTICS

( $V_{CC} = +5V$ ,  $V_{EE} = -5V$ ,  $V_{IN} = 0V$ ,  $R_L = 100\Omega$ ,  $T_A = +25^\circ C$ .)

PARAMETER	SYMBOL	CONDITIONS		MIN	TYP	MAX	UNITS
Small-Signal -3dB Bandwidth	BW-3dB	MAX496CSE		375		MHz	
		MAX496CPE		375			
		MAX497CSE		275			
		MAX497CPE		275			
Full-Power Bandwidth	FPBW	$V_{OUT} = \pm 2V$	MAX496	230		MHz	
			MAX497	215			
Slew Rate	SR	$V_{OUT} = 4V$ step, MAX496		1600		V/ $\mu$ s	
		$V_{OUT} = 4V$ step, MAX497		1500			
Settling Time	$t_s$	0.1% ( $V_{OUT} = 2V$ step)		12		ns	
Differential Gain Error	DG	$f = 3.58MHz$ (Note 3)		0.01		%	
Differential Phase Error	DP	$f = 3.58MHz$ (Note 3)		0.01		degrees	
Input Noise Voltage Density		$f = 10MHz$		5.6		nV/ $\sqrt{Hz}$	
Input Noise Current Density		$f = 10MHz$		2		pA/ $\sqrt{Hz}$	
Gain Flatness		$\pm 0.1dB$	MAX496CPE	80		MHz	
			MAX496CSE	80			
			MAX497CPE	100			
			MAX497CSE	120			
Adjacent Channel Crosstalk		(Note 4)	MAX496	78		dB	
			MAX497	72			
All-Hostile Crosstalk		(Note 4)	MAX496	72		dB	
			MAX497	65			
Total Harmonic Distortion	THD	$f_C = 10MHz$ , $V_{OUT} = 2Vp-p$	MAX496	-64		dBc	
			MAX497	-58			
Spurious-Free Dynamic Range	SFDR	$f_C = 5MHz$	MAX496	58		dBc	
			MAX497	60			

**Note 1:** Voltage Gain =  $(V_{OUT} - V_{OS}) / V_{IN}$ , measured at  $V_{IN} = \pm 1V$ .

**Note 2:** Voltage Gain =  $(V_{OUT} - V_{OS}) / V_{IN}$ , measured at  $V_{IN} = \pm 2V$ .

**Note 3:** Input test signal is a 3.58MHz sine wave of amplitude 40 IRE superimposed on a linear ramp (0 IRE to 100 IRE).  $R_L = 150\Omega$ , see Figure 2.

**Note 4:** Input of channel under test grounded through 75 $\Omega$ . Adjacent channel driven at  $f = 10MHz$  (Figure 4a). For All-Hostile Crosstalk, all inputs are driven except the channel under test (Figure 4b).

# 375MHz Quad Closed-Loop Video Buffers, $A_v = +1$ and $+2$

## Typical Operating Characteristics

( $V_{CC} = +5V$ ,  $V_{EE} = -5V$ ,  $R_L = 100\Omega$ ,  $T_A = +25^\circ C$ , unless otherwise noted.)

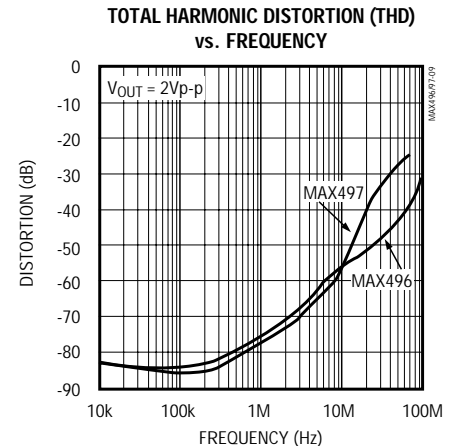
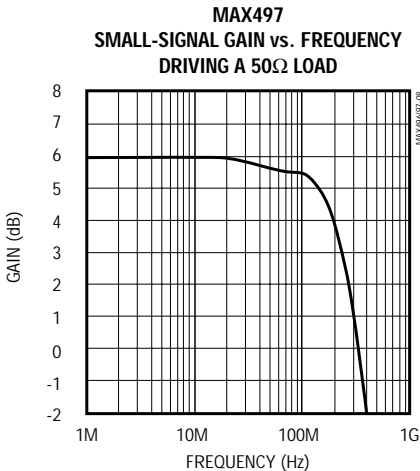
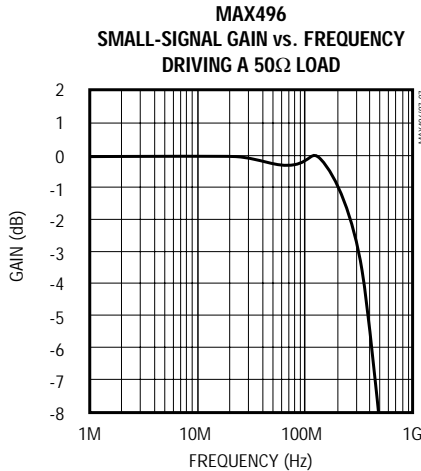
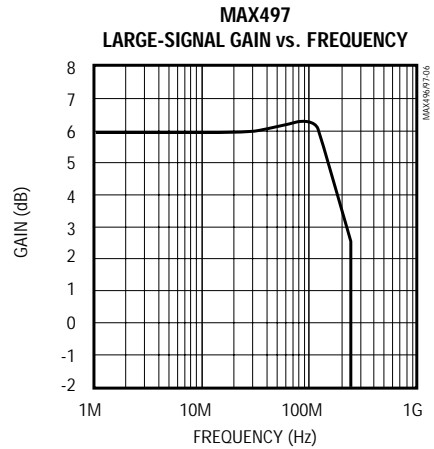
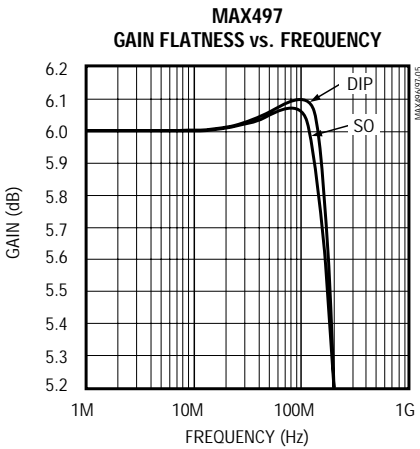
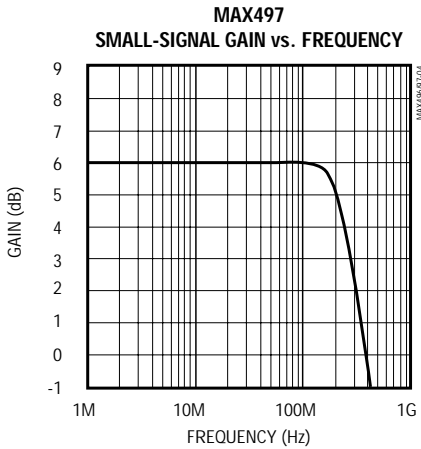
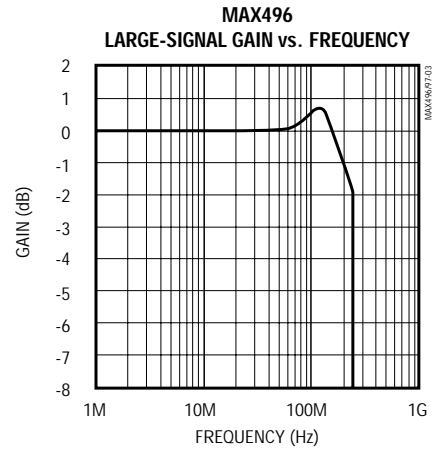
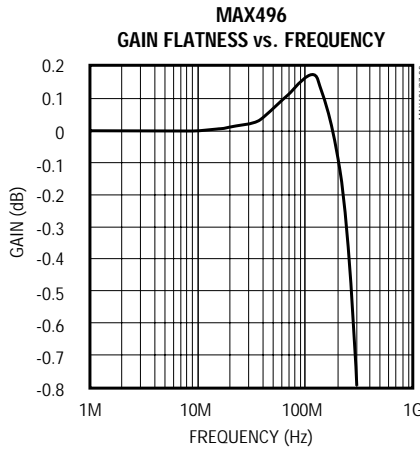
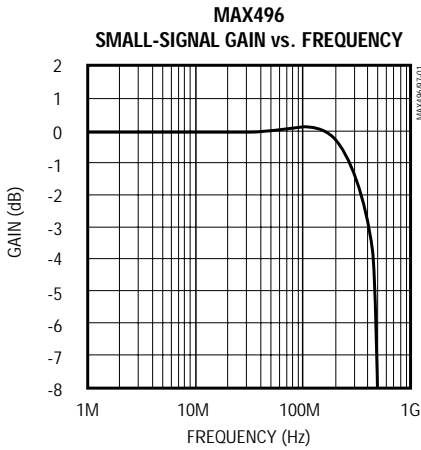

# 375MHz Quad Closed-Loop Video Buffers, $A_v = +1$ and $+2$

## Typical Operating Characteristics (continued)

( $V_{CC} = +5V$ ,  $V_{EE} = -5V$ ,  $R_L = 100\Omega$ ,  $T_A = +25^\circ C$ , unless otherwise noted.)

MAX496/MAX497

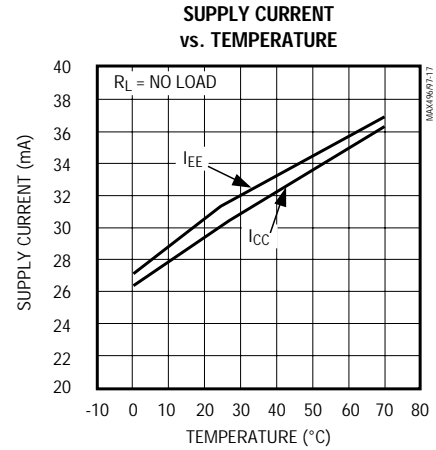
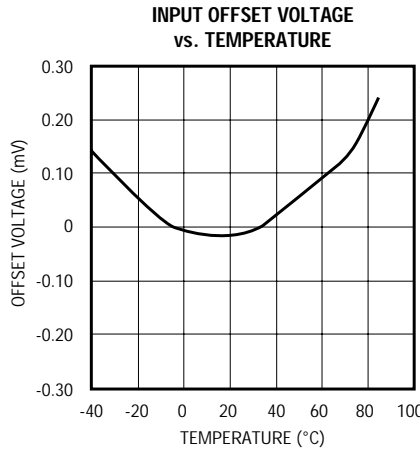
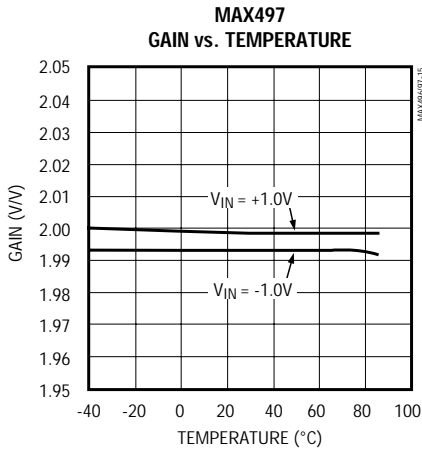
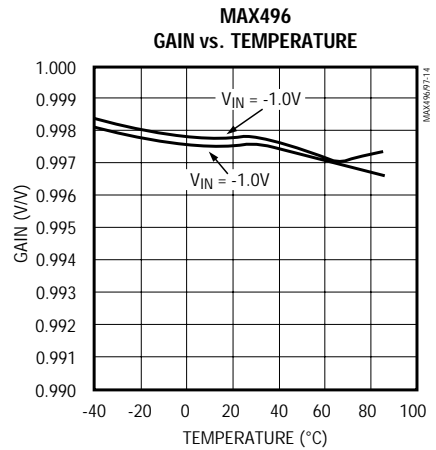
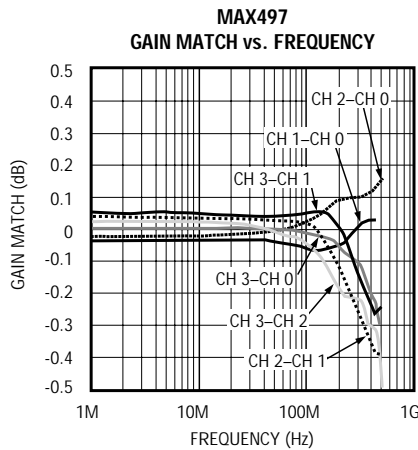
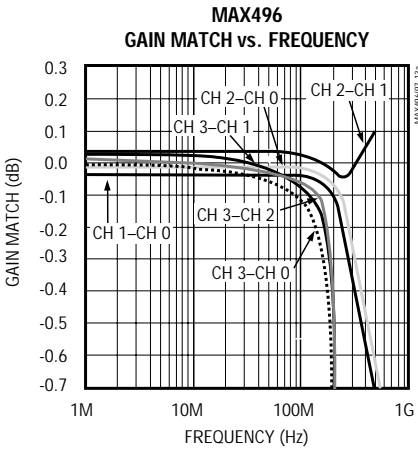
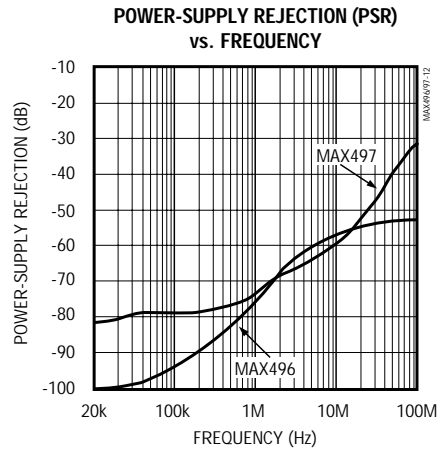
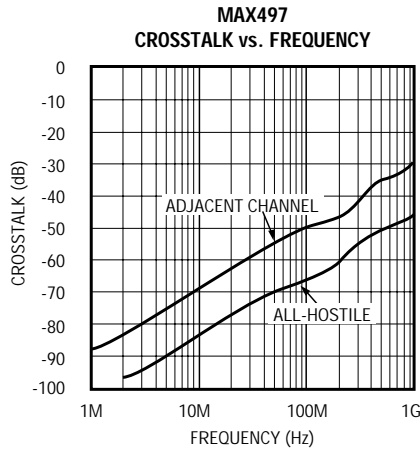
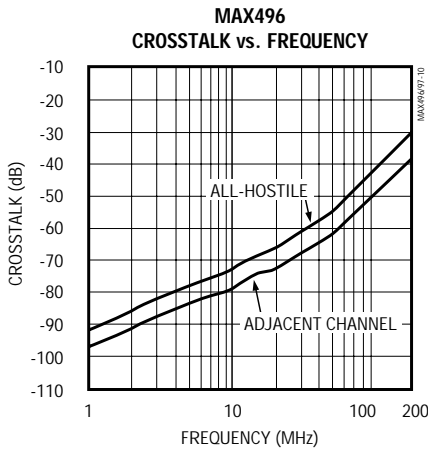

# 375MHz Quad Closed-Loop Video Buffers, $A_v = +1$ and $+2$

## Typical Operating Characteristics (continued)

( $V_{CC} = +5V$ ,  $V_{EE} = -5V$ ,  $R_L = 100\Omega$ ,  $T_A = +25^\circ C$ , unless otherwise noted.)

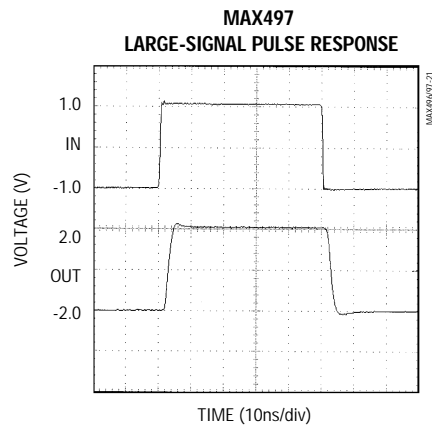
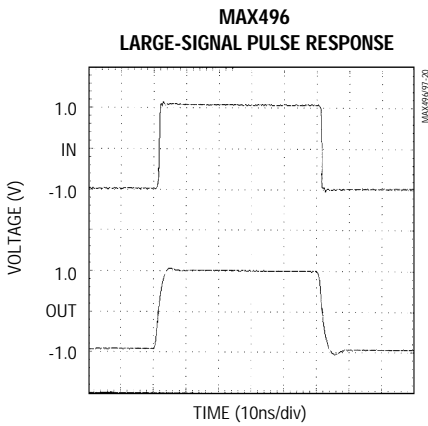
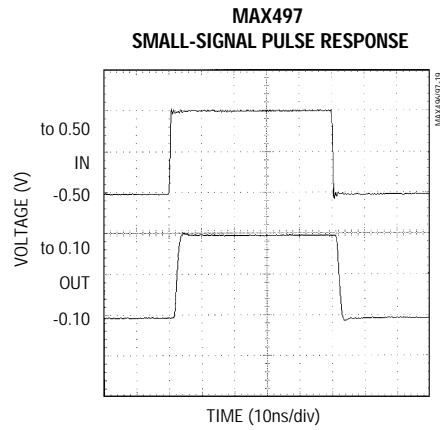
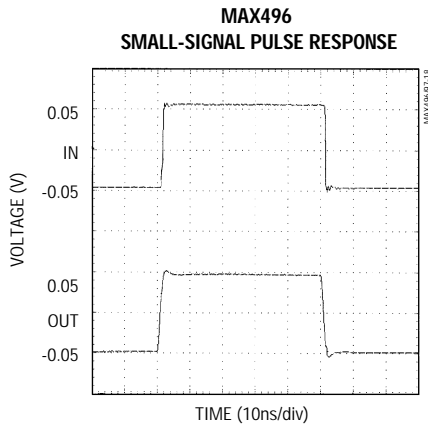

# 375MHz Quad Closed-Loop Video Buffers, $A_v = +1$ and $+2$

## Typical Operating Characteristics (continued)

( $V_{CC} = +5V$ ,  $V_{EE} = -5V$ ,  $R_L = 100\Omega$ ,  $T_A = +25^\circ C$ , unless otherwise noted.)

MAX496/MAX497

**MAX496**  
SMALL-SIGNAL PULSE RESPONSE  
( $C_L = 47pF$ )

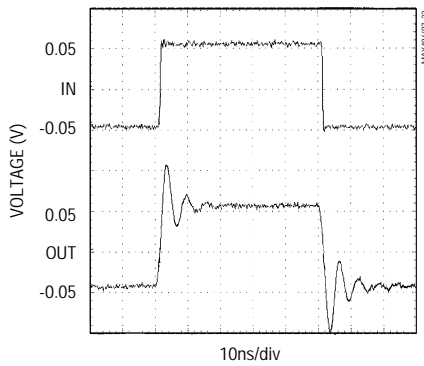

**MAX497**  
SMALL-SIGNAL PULSE RESPONSE  
( $C_L = 47pF$ )

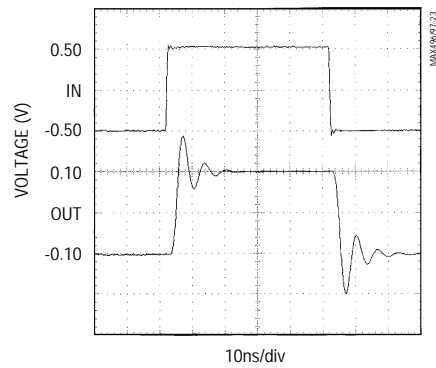

**MAX496**  
LARGE-SIGNAL PULSE RESPONSE  
( $C_L = 47pF$ )

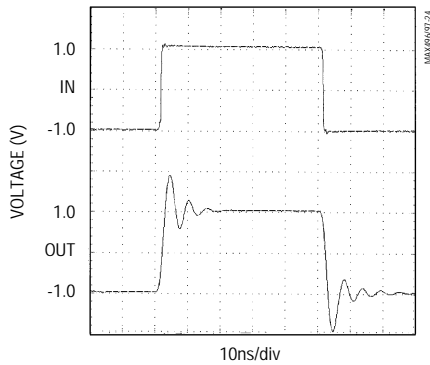

**MAX497**  
LARGE-SIGNAL PULSE RESPONSE  
( $C_L = 47pF$ )

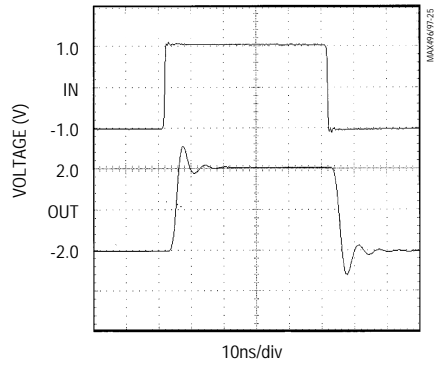

# 375MHz Quad Closed-Loop Video Buffers, $A_V = +1$ and $+2$

## Pin Description

PIN	NAME	FUNCTION
1, 3, 5, 7	GND	Ground. All ground pins are internally connected. Connect all ground pins externally to minimize the ground impedance.
2	IN0	Channel 0 Input
4	IN1	Channel 1 Input
6	IN2	Channel 2 Input
8	IN3	Channel 3 Input
9, 15	V <sub>CC</sub>	Positive Power Supply. Connect to +5V. V <sub>CC</sub> pins are internally connected. Connect both pins to +5V externally to minimize the supply impedance.
10	OUT3	Channel 3 Output
11, 13	V <sub>EE</sub>	Negative power supply. Connect to -5V. V <sub>EE</sub> pins are internally connected. Connect both pins to -5V externally to minimize the supply impedance.
12	OUT2	Channel 2 Output
14	OUT1	Channel 1 Output
16	OUT0	Channel 0 Output

## Detailed Description

The MAX496/MAX497 are quad, high-speed, closed-loop voltage-feedback video amplifiers with fixed gain settings of +1 and +2, respectively (Figure 1). These amplifiers use a unique two-stage voltage-feedback architecture that combines the benefits of conventional voltage-feedback and current-mode-feedback topologies. They achieve wide bandwidths and high slew rates while maintaining precision. A resistively loaded first stage provides low input-referred noise even with low supply currents of 8mA per amplifier. The above features, along with the ability to drive 50Ω or 75Ω back-terminated cables to ±2.8V and low differential phase and gain errors, make these amplifiers ideal for the most demanding component and composite video applications.

## Applications Information

The feedback elements of the MAX496/MAX497 are included internally in the device to set the closed-loop gain to  $A_V = +1$  and  $A_V = +2$ , respectively. Closing the loop internally on the chip minimizes problems associated with the board and package parasitics influencing the amplifier's frequency response.

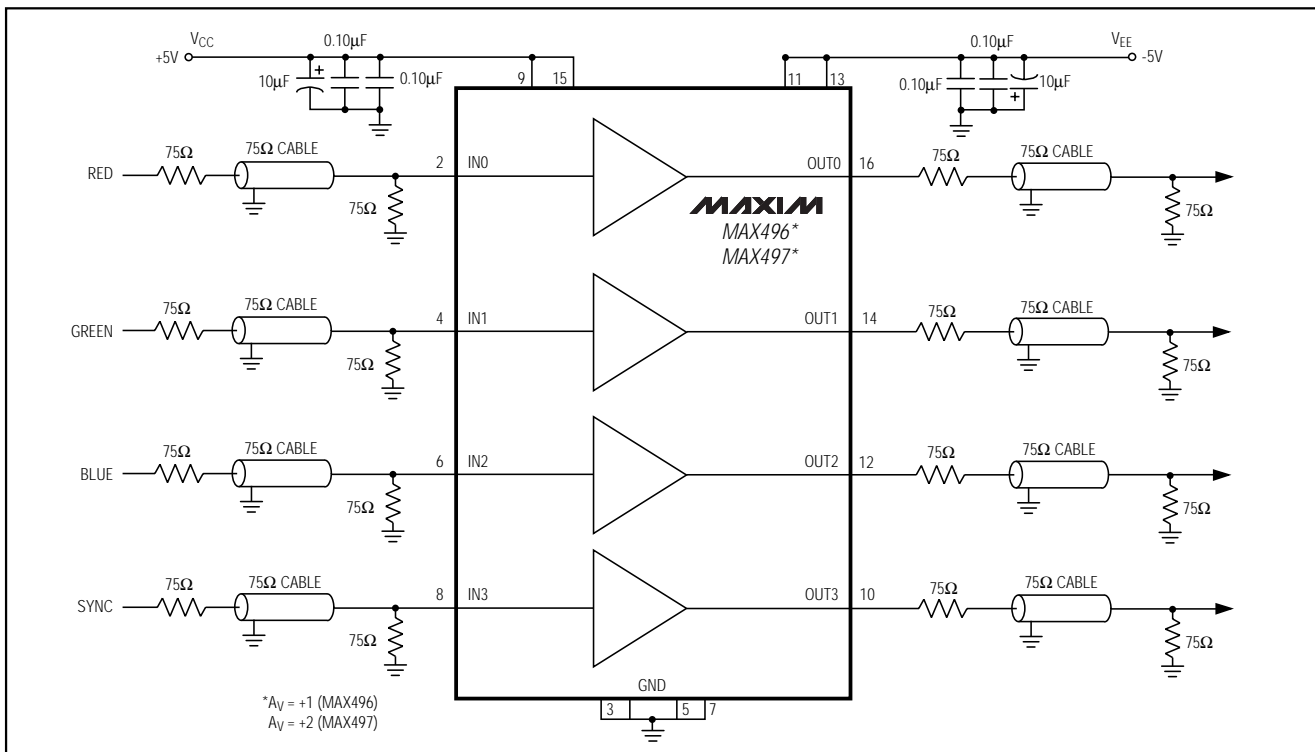

Figure 1. Typical Operating Circuit



# 375MHz Quad Closed-Loop Video Buffers, $A_v = +1$ and $+2$

MAX496/MAX497

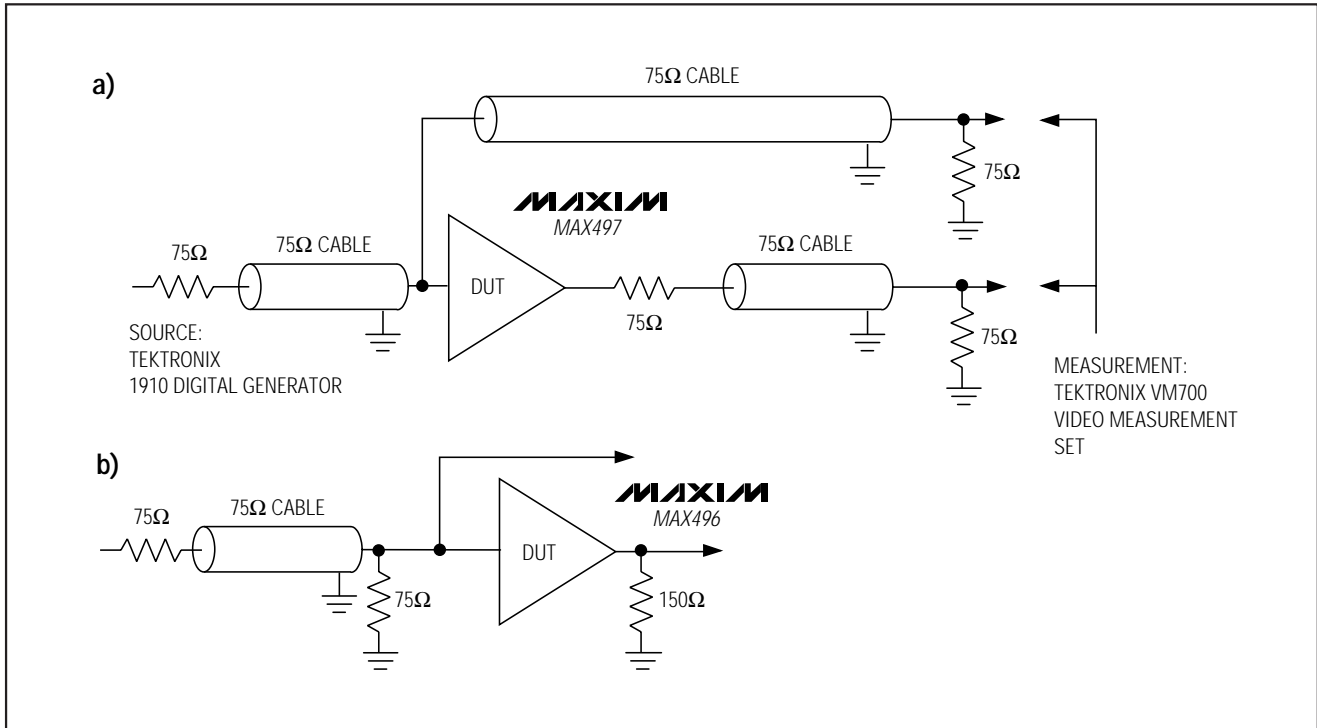

Figure 2. Differential Phase and Gain Error Test Circuits: a) MAX497, Gain of +2 Amplifier; b) MAX496 Unity-Gain Amplifier

## Power Dissipation

The maximum output current of the MAX496/MAX497 is limited by the packages maximum allowable power dissipation. The maximum junction temperature should not exceed  $+150^{\circ}\text{C}$ . The power dissipation increases with load, and this increase can be approximated by the following:

$$\text{For } V_{\text{OUT}} > 0\text{V: } |V_{\text{CC}} - V_{\text{OUT}}| I_{\text{LOAD}} \\ \text{OR}$$

$$\text{For } V_{\text{OUT}} < 0\text{V: } |V_{\text{EE}} - V_{\text{OUT}}| I_{\text{LOAD}}.$$

These devices can drive  $100\Omega$  loads connected to each of the outputs over the entire rated output swing and temperature range. When driving  $50\Omega$  loads with each of the four outputs simultaneously, the output swing must be limited to  $\pm 1.25\text{V}$  at  $T_{\text{A}} = +70^{\circ}\text{C}$ . While the output is short-circuit protected to  $170\text{mA}$ , this does not necessarily guarantee that, under all conditions, the maximum junction temperature will not be exceeded. Do not exceed the derating values given in the absolute maximum ratings.

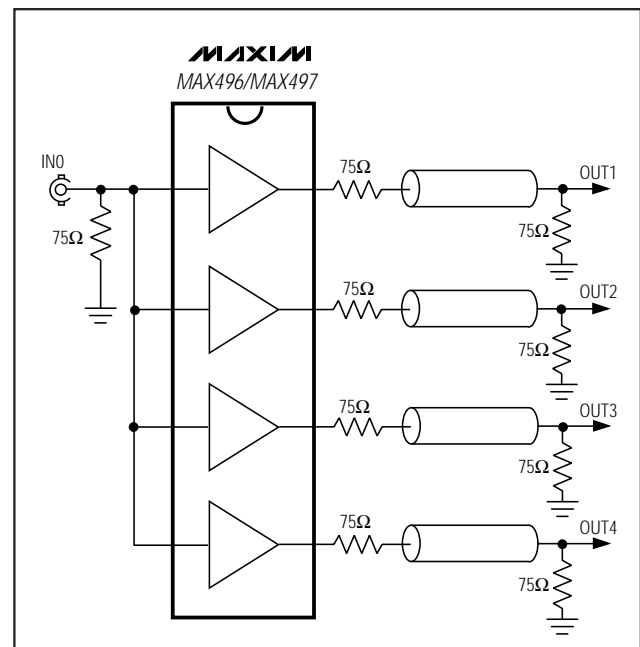

Figure 3. One-to-Four Distribution Amplifier

## 375MHz Quad Closed-Loop Video Buffers, $A_v = +1$ and $+2$

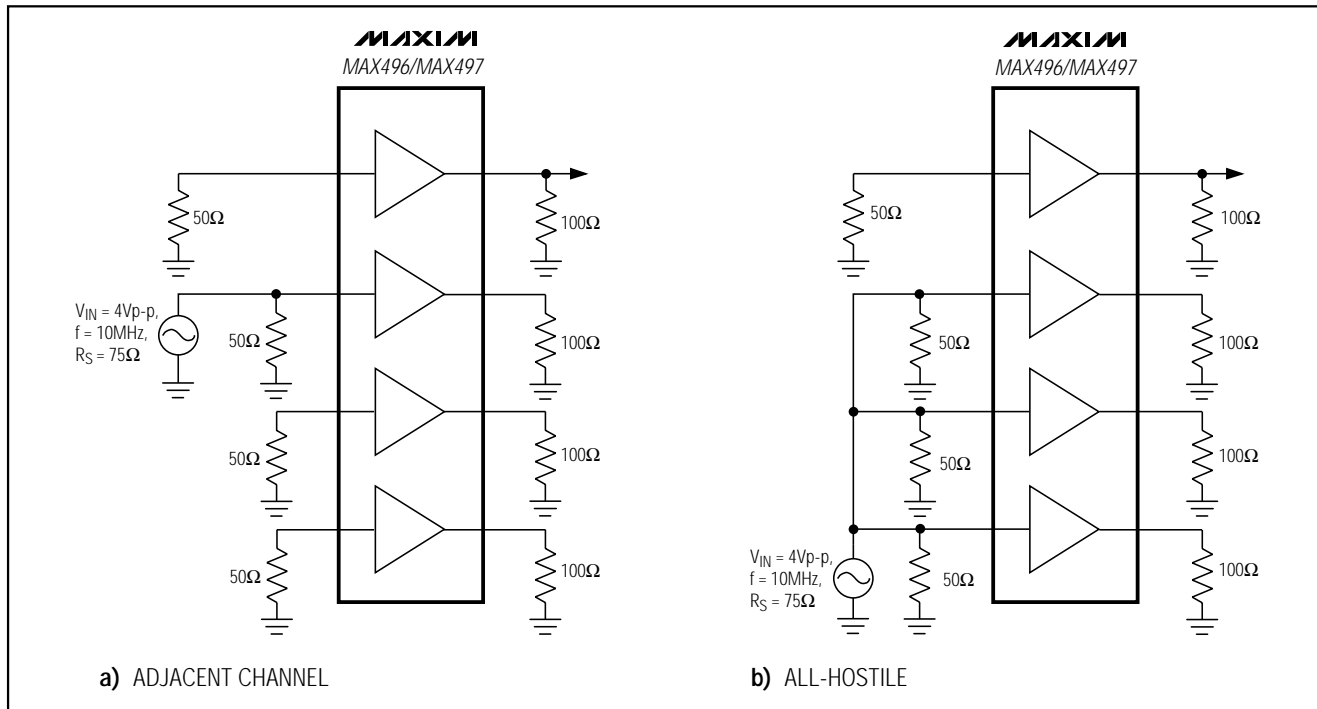

Figure 4. Crosstalk: a) Adjacent Channel; b) All-Hostile

### Total Noise

The MAX496/MAX497's low input current noise of  $2\text{pA}/\sqrt{\text{Hz}}$  and voltage noise of  $5.6\text{nV}/\sqrt{\text{Hz}}$  provide for lower total noise compared to typical current-mode-feedback amplifiers, which usually have significantly higher input current noise. The input current noise multiplied by the feedback resistor is the dominant noise source of current-mode-feedback amplifiers.

### Differential Gain and Phase Errors

Differential gain and phase errors are critical specifications for a buffer in composite (NTSC, PAL, SECAM) video applications, because these errors correspond directly to color changes in the displayed picture of composite video systems. The MAX496/MAX497's ultra-low differential gain and phase errors ( $0.01\%/ 0.01^\circ$ ) make them ideal in broadcast-quality composite video applications.

### Distribution Amplifier

The circuit in Figure 3 is a one-to-four distribution amplifier using a single MAX496 or MAX497 IC. A one-to-eight distribution amplifier can be implemented with a MAX496 or MAX497 by driving an additional cable from each of the four outputs. When driving more than four outputs from a single device, see the Continuous Power Dissipation specifications in the *Absolute Maximum Ratings*.

### Coaxial Cable Drivers

High-speed performance, excellent output current capability, and an internally fixed gain of  $+2$  make the MAX497 ideal for driving back-terminated  $50\Omega$  or  $75\Omega$  coaxial cables to  $\pm 2.8\text{V}$ .

In a typical application, the MAX497 drives a back-terminated  $75\Omega$  video cable (Figure 1). The back-termination resistor (at the MAX497's output) matches the impedance of the cable's driven end to the cable's impedance, to eliminate signal reflections. This, along with the load-termination resistor, forms a voltage divider with the load impedance, which attenuates the signal at the cable output by one-half. The MAX497 operates with an internal  $+2V/V$  closed-loop gain to provide unity gain at the cable's output.

### Capacitive Load Driving

In most amplifier circuits, driving large capacitive loads increases the likelihood of oscillation. This is especially true for circuits with high loop gains, such as voltage followers. The amplifier's output resistance and the capacitive load form an RC filter that adds a pole to the loop response. If the pole frequency is low enough (as when driving a large capacitive load), the circuit phase margin is degraded and oscillation may occur.

# 375MHz Quad Closed-Loop Video Buffers, $A_v = +1$ and $+2$

MAX496/MAX497

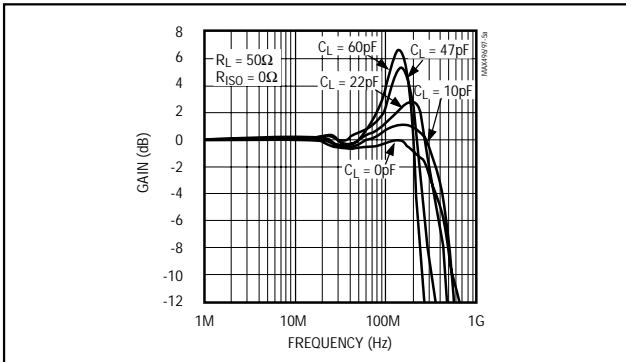

Figure 5a. MAX496 Small-Signal Gain vs. Frequency and Load Capacitor ( $R_L = 50\Omega$ ,  $R_{ISO} = 0\Omega$ )

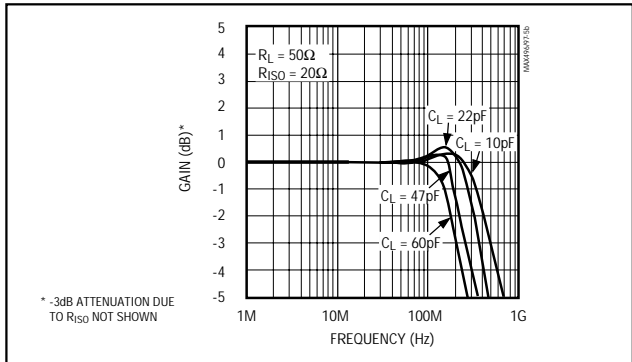

Figure 5b. MAX496 Small-Signal Gain vs. Frequency and Load Capacitor ( $R_L = 50\Omega$ ,  $R_{ISO} = 20\Omega$ )

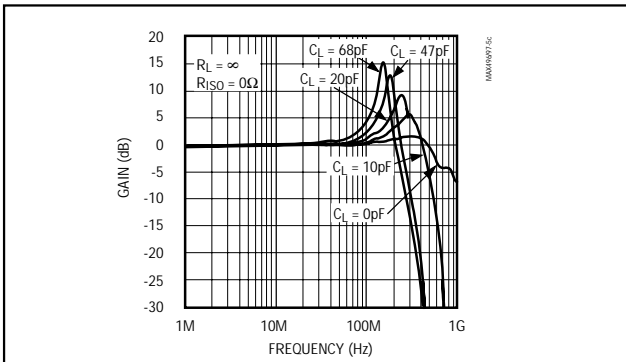

Figure 5c. MAX496 Small-Signal Gain vs. Frequency and Load Capacitor ( $R_L = \infty$ ,  $R_{ISO} = 0\Omega$ )

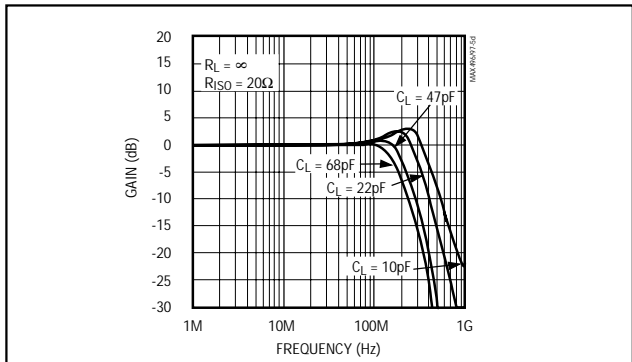

Figure 5d. MAX496 Small-Signal Gain vs. Frequency and Load Capacitor ( $R_L = \infty$ ,  $R_{ISO} = 20\Omega$ )

The MAX496/MAX497 drive capacitive loads up to 75pF without sustained oscillation, although some peaking may occur. When driving larger capacitive loads, or to reduce peaking, add an isolation resistor ( $R_{ISO}$ ) between the output and the capacitive load (Figures 5a–5d).

### Grounding and Layout

The MAX496/MAX497 bandwidths are in the RF frequency range. Depending on the size of the PC board used and the frequency of operation, it may be necessary to use Micro-strip or Stripline techniques.

To realize the full AC performance of these high-speed buffers, pay careful attention to power-supply bypassing and board layout. The PC board should have at least two layers (wire-wrap boards are too inductive, bread boards are too capacitive), with one side a signal layer and the other a large, low-impedance ground plane. With multilayer boards, locate the ground plane on the layer that is not dedicated to a specific signal trace. The ground plane should be as free from voids as possible. Connect all ground pins to the ground plane.

Connect both positive power-supply pins together and bypass with a 0.10 $\mu$ F ceramic capacitor at each power supply pin, as close to the device as possible. Repeat the same for the negative power-supply pins. The capacitor lead lengths should be as short as possible to minimize lead inductance; surface-mount chip capacitors are ideal. A large-value (4.7 $\mu$ F or greater) tantalum or electrolytic bypass capacitor on each supply may be required for high-current loads. The location of this capacitor is not critical.

The MAX496/MAX497's analog input pins are isolated with ground pins to minimize parasitic coupling, which can degrade crosstalk and/or amplifier stability. Keep signal paths as short as possible to minimize inductance. Ensure that all input channel traces are the same length to maintain the phase relationship between the four channels. To further reduce crosstalk, connect the coaxial-cable shield to the ground side of the 75 $\Omega$  terminating resistor at the ground plane, and terminate all unused inputs ground and outputs with a 100 $\Omega$  or 150 $\Omega$  resistor to ground.

# 375MHz Quad Closed-Loop Video Buffers, $A_v = +1$ and $+2$

## Chip Topography

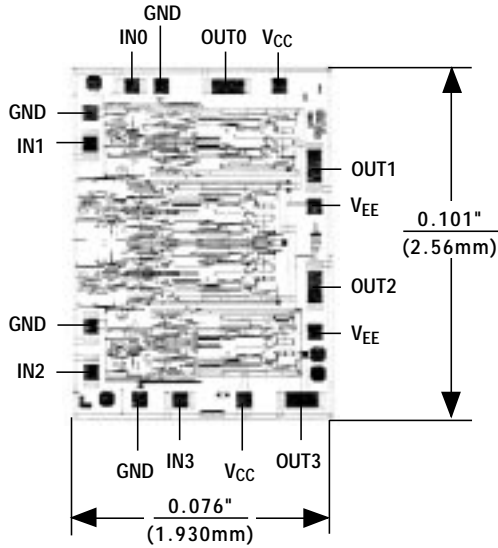

TRANSISTOR COUNT: 544  
 SUBSTRATE CONNECTED TO  $V_{EE}$

## Package Information

INCHES				MILLIMETERS			
	MIN	MAX		MIN	MAX		
A	0.053	0.069	1.35	1.75			
A1	0.004	0.010	0.10	0.25			
B	0.014	0.019	0.35	0.49			
C	0.007	0.010	0.19	0.25			
e	0.050		1.27				
E	0.150	0.157	3.80	4.00			
H	0.228	0.244	5.80	6.20			
h	0.010	0.020	0.25	0.50			
L	0.016	0.050	0.40	1.27			

INCHES				MILLIMETERS			
	MIN	MAX		MIN	MAX	N	MS012
D	0.189	0.197	4.80	5.00	8	A	
D	0.337	0.344	8.55	8.75	14	B	
D	0.386	0.394	9.80	10.00	16	C	

NOTES:  
 1. DSE DO NOT INCLUDE MOLD FLASH  
 2. MOLD FLASH OR PROTRUSIONS NOT TO EXCEED .15mm (.006")  
 3. LEADS TO BE COPLANAR WITHIN .102mm (.004")  
 4. CONTROLLING DIMENSION: MILLIMETER  
 5. MEETS JEDEC MS012-XX AS SHOWN IN ABOVE TABLE  
 6. N = NUMBER OF PINS