

<b>SANYO</b>	No.855F	LA2110
		FM Noise Canceller

The LA2110 has the capability to effectively remove external noise (pulse noise) caused by engine, etc. and is used in conjunction with a PLL FM multiplex stereo demodulator (such as LA3375) with pilot signal canceller.

**Features**

- Pilot signal compensation function.
- By using in conjunction with PLL FM multiplex stereo demodulator with pilot signal canceller, adverse effect caused by pilot signal can be compensated.
- Low distortion factor: THD=0.02%, 300mV.
- Good space facator due to single end package.
- Variable input type noise AGC system. This system widens the noise detector's dynamic range, so that pulse noise can be satisfactorily detected even in a weak electric field, and pulse noise is removed without adversely affecting distortion factor.

**Maximum Ratings at Ta = 25°C**

			unit
Maximum Supply Voltage	V <sub>CCmax</sub>	16	V
Allowable Power Dissipation	P <sub>dmax</sub> Ta ≤ 50°C	450	mW
Operating Temperature	T <sub>opr</sub>	-20 to +75	°C
Storage Temperature	T <sub>stg</sub>	-40 to +125	°C

**Recommended Operating Conditions at Ta = 25°C**

			unit
Recommended Supply Voltage	V <sub>CC</sub>	12	V
Operating Voltage Range	V <sub>CC op</sub>	8 to 15	V

**Operating Conditions at Ta = 25°C, V<sub>CC</sub> = 12V, See specified Test Circuit.**

		(input pin)	(output pin)	min	typ	max	unit
Quiescent Current	I <sub>cco</sub>				16	25	mA
Voltage Gain	V <sub>G</sub>	V <sub>7</sub> =300mV, f=1kHz	Output	-0.2	0.8	1.8	dB
Input Signal Dynamic Range	V <sub>D</sub>	V <sub>7</sub> ,f=1kHz	Output, THD=1%	1.3			V
Input Impedance	Z <sub>in</sub>	V <sub>7</sub> =300mV, f=1kHz		36k	51k	67k	Ω
Total Harmonic Distortion	THD	V <sub>7</sub> =300mV, f=1kHz	Output		0.01	0.03	%
Low-pass Amp Gain	V <sub>GL</sub>	V <sub>5</sub> =300mV, f=1kHz	V <sub>4</sub>	1.0	1.1	1.2	times

**Package Dimensions** Continued on next page.  
(unit: mm)  
3020A

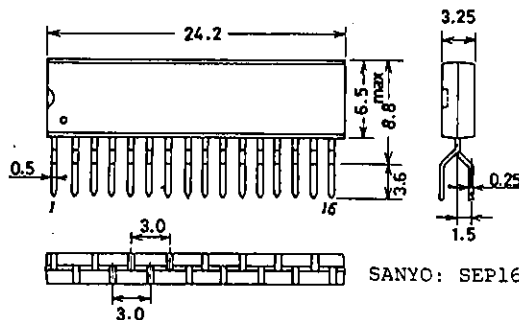

LA2110

Continued from preceding page.

	(input pin)	(output pin)	min	typ	max	unit
High-pass Amp Gain	$V_{GH}$ $V_9=100\text{mV}$ , $f=200\text{kHz}$	$V_{10}$	1.2	1.4	1.65	times
Inverting Amp Distortion Factor	$THD_I$ $V_{15}=100\text{mV}$ , $f=19\text{kHz}$	Output			0.1	%
Inverting Amp Dynamic Range	$VD_I$ $V_{15}, f=19\text{kHz}$	Output, $THD=1\%$	300			mV
Inverting Amp Gain	$V_{G_I}$ $V_{15}=100\text{mV}$ , $f=19\text{kHz}$	Output	1.0	1.3	1.6	times
Output Noise Voltage	$V_{NO}$ $V_7, V_{15}$ shorted to GND	Output, 100kHz low-pass filter		30	60	$\mu\text{V}$
Gate Time	$t_{gate}$ $V_7=100\text{mVp-p}$ , $1\mu\text{s}, f=1\text{kHz}$	Output	13	21	30	$\mu\text{s}$
Noise Sensitivity	$S_N$ $V_7, 1\mu\text{s}, f=1\text{kHz}$	Output			30mVp-0	

[Test Circuit]

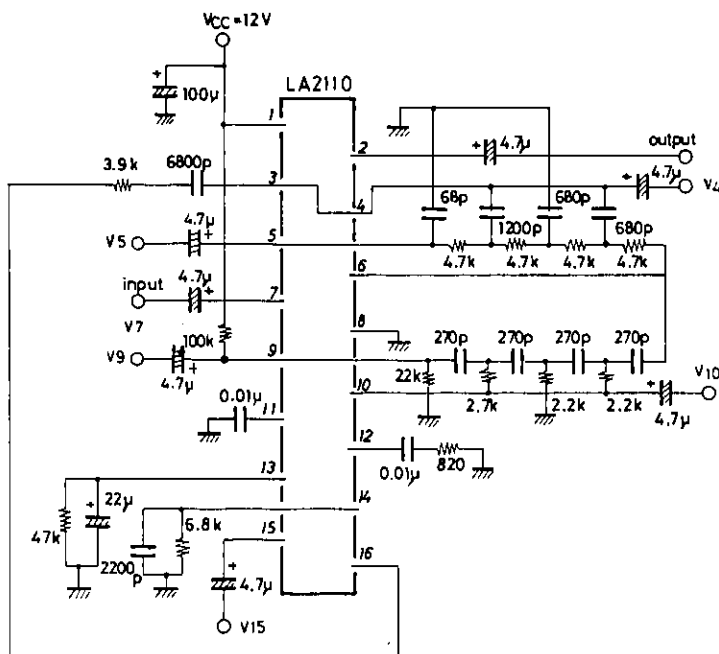

Unit (resistance:  $\Omega$ , capacitance: F)

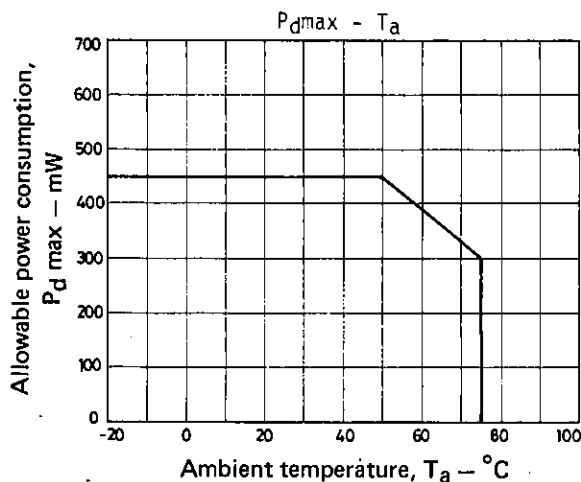

Equivalent Circuit Block Diagram

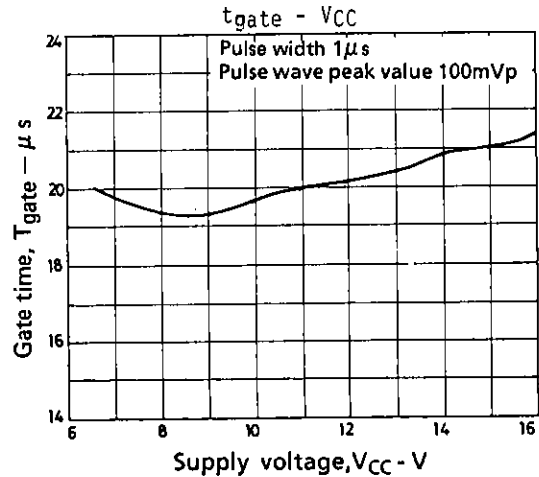
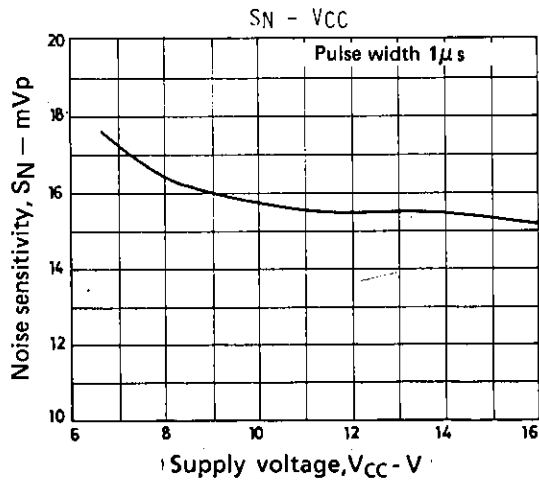
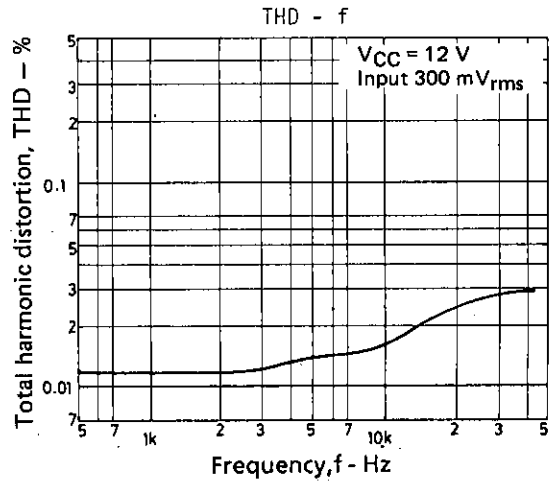
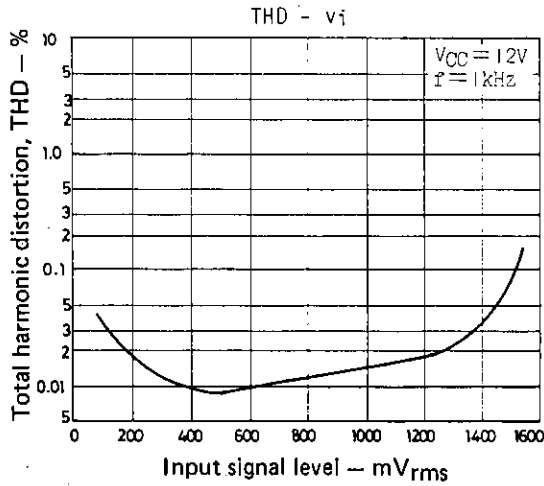
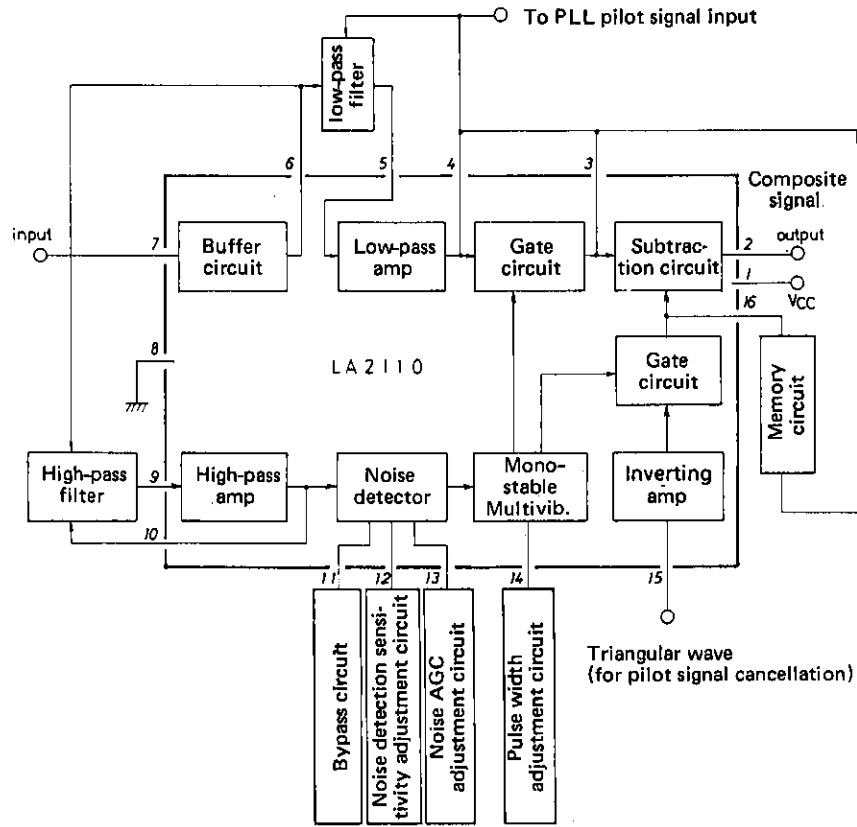

[Theory of LA2110 Noise Canceller]

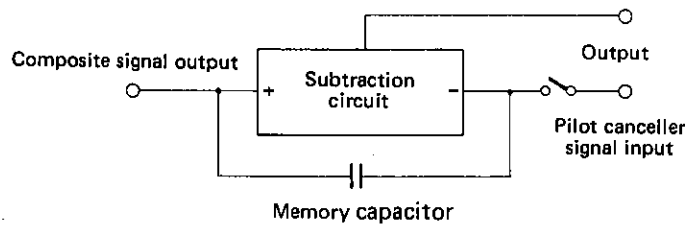

In order to simplify the operation theory, the composite signal component is given only as a low frequency signal and a pilot signal, and the pilot cancel signal has the same phase, same amplitude as the pilot signal in the composite signal.

Since the output voltage is the differential voltage of the plus and minus input of the subtraction circuit, it is equal to the voltage between the memory capacitor terminals. When the gate is closed, the composite signal is applied to the plus input terminal of the subtraction circuit, and the pilot cancel signal is applied to the minus input terminal. Thus the pilot signal is cancelled from the output and only the low frequency signal appears. In the same way, the voltage between the memory capacitor terminals is the differential voltage of the composite signal and the pilot cancel signal, so only the low frequency signal appears.

When pulse noise is generated and the gate opens, the plus input and minus input signal waveforms of the subtraction circuit become equal. This is because the input impedance of the subtraction circuit is extremely high, so the memory capacitor is considered AC-shorted. Thus, when pulse noise is generated in the composite signal, the same pulse noise appears in minus as well as plus input of the subtraction circuit. As a result, pulse noise does not appear in the output. The voltage in the output has a DC level difference of plus and minus input, and that is the voltage held by the memory capacitor. This voltage is that between the memory capacitor terminals just before the gate opens, so it is the low frequency signal voltage just before the gate opens. Because the subtraction circuit input impedance is high, no charge/discharge current flows in the memory capacitor while the gate is open, so the memory capacitor can hold the voltage between its terminals.

The voltage waveforms are illustrated below.

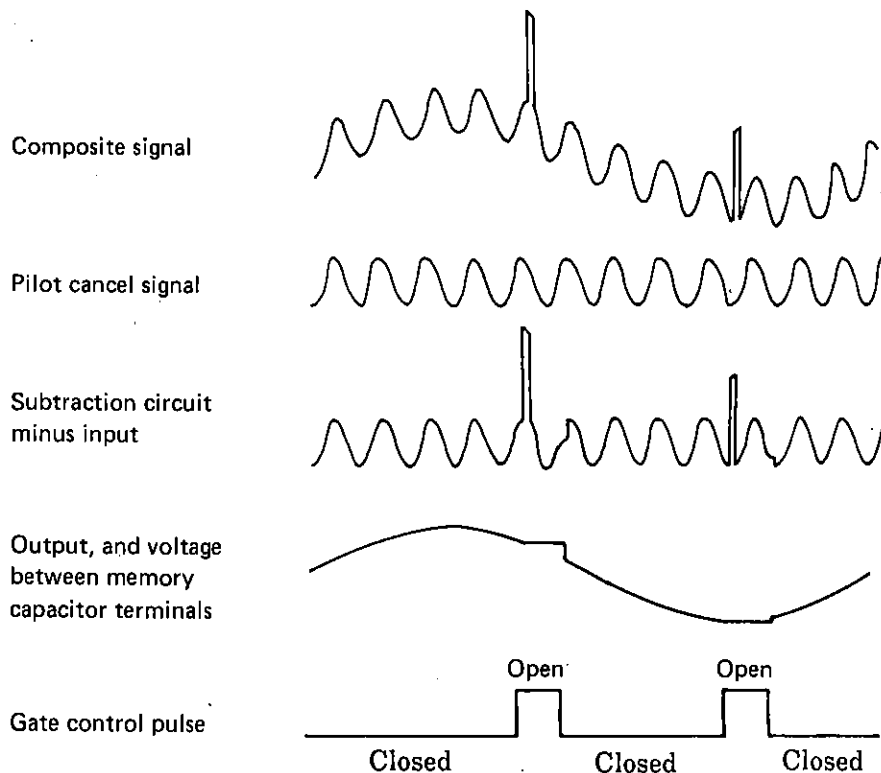

Note: The pilot cancel signal is given as sinusoidal in this explanation, but in the actual application circuit, pilot cancel is performed by a triangular wave.

# LA2110

## Sample Application Circuit: LA2110 & LA3375

Unit (resistance:  $\Omega$ , capacitance: F)

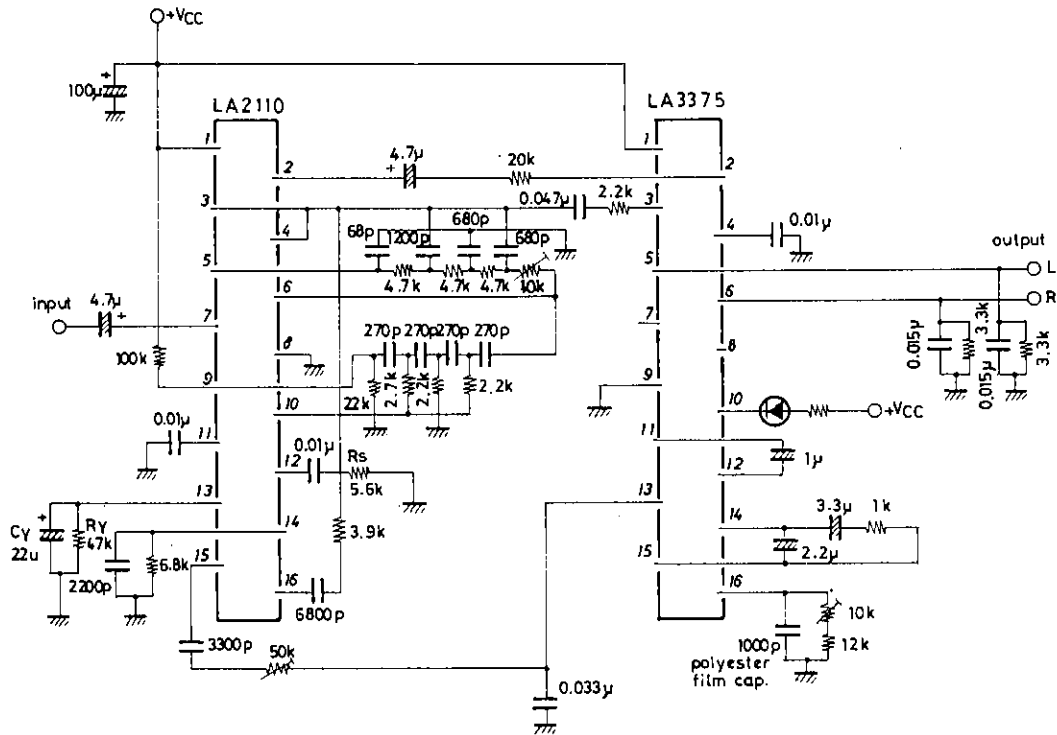

Note: When using the sample application circuit:

1. Separation adjustment is performed with  $10k\Omega$  variable resistance in low-pass filter.
2. Change noise detection sensitivity control  $R_S$  to an adequate value for strong or medium electric field.
3. Adjust noise AGC with  $C_Y$ ,  $R_Y$  for effective noise suppression in a medium or weak electric field.
4. Adjust pilot cancel degree with variable resistance of  $50k\Omega$  connected to LA2110 pin 15.
5. By changing the  $1\mu F$  capacitor between LA3375 pin 11 and 12, pilot cancel follow-up response time can be changed. But if the value is decreased, distortion factor, etc. will be adversely affected.

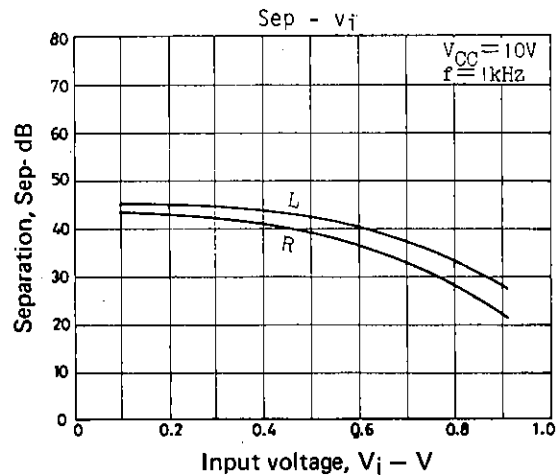
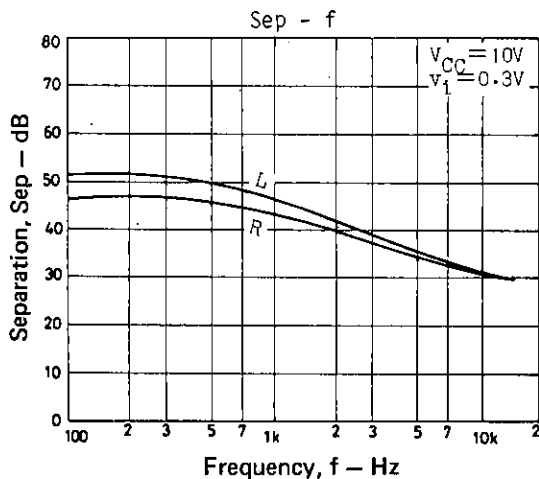

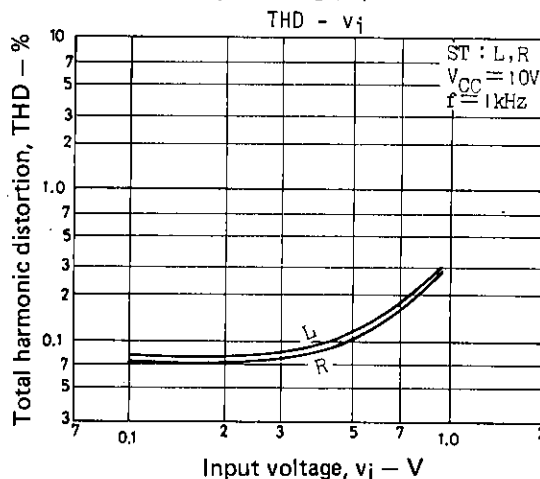
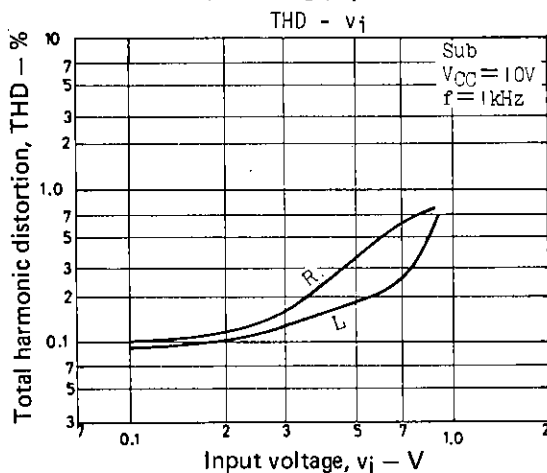
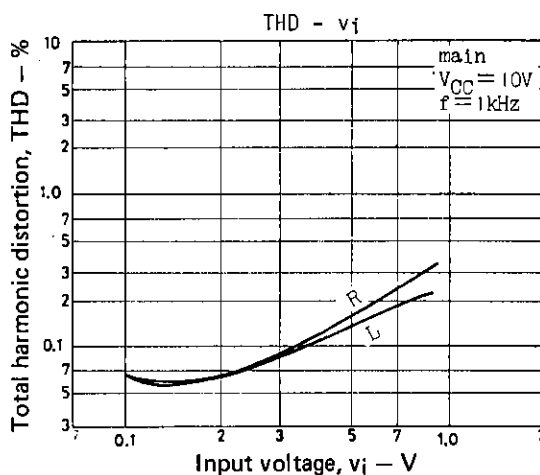
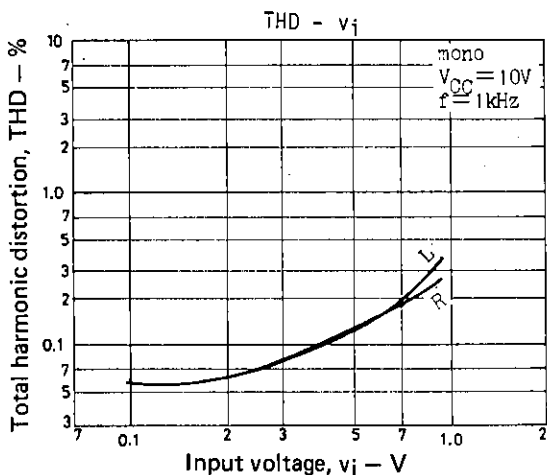

- No products described or contained herein are intended for use in surgical implants, life-support systems, aerospace equipment, nuclear power control systems, vehicles, disaster/crime-prevention equipment and the like, the failure of which may directly or indirectly cause injury, death or property loss.
- Anyone purchasing any products described or contained herein for an above-mentioned use shall:
  - ① Accept full responsibility and indemnify and defend SANYO ELECTRIC CO., LTD., its affiliates, subsidiaries and distributors and all their officers and employees, jointly and severally, against any and all claims and litigation and all damages, cost and expenses associated with such use.
  - ② Not impose any responsibility for any fault or negligence which may be cited in any such claim or litigation on SANYO ELECTRIC CO., LTD., its affiliates, subsidiaries and distributors or any of their officers and employees jointly or severally.
- Information (including circuit diagrams and circuit parameters) herein is for example only; it is not guaranteed for volume production. SANYO believes information herein is accurate and reliable, but no guarantees are made or implied regarding its use or any infringements of intellectual property rights or other rights of third parties.