

# HMC174MS8

## GaAs MMIC T/R SWITCH DC - 3 GHz

### Typical Applications

The HMC174MS8 is ideal for:

- ISM Applications
- PCMCIA Wireless Cards
- Portable Wireless

### Functional Diagram

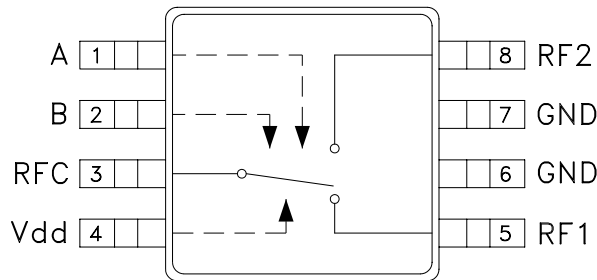

### Features

- Ultra Small Package: MSOP8
- High Third Order Intercept: +60 dBm
- Single Positive Supply: +3 to +10V
- High RF power Capability

### General Description

The HMC174MS8 is a low-cost SPDT switch in an 8-lead MSOP package for use in transmit-receive applications which require very low distortion at high signal power levels. The device can control signals from DC to 3.0 GHz and is especially suited for 900 MHz, 1.8 - 2.2 GHz, and 2.4 GHz ISM applications with only 0.5 dB loss. The design provides exceptional intermodulation performance; providing a +60 dBm third order intercept at 8 Volt bias. RF1 and RF2 are reflective shorts when "OFF". On-chip circuitry allows single positive supply operation at very low DC current with control inputs compatible with CMOS and most TTL logic families.

### Electrical Specifications, $T_A = +25^\circ C$ , $V_{dd} = +5 V_{dc}$ , 50 Ohm System

Parameter	Frequency	Min.	Typ.	Max.	Units
Insertion Loss	DC - 1.0 GHz		0.5	0.7	dB
	DC - 2.0 GHz		0.5	0.8	dB
	DC - 2.5 GHz		0.7	1.0	dB
	DC - 3.0 GHz		1.4	1.8	dB
Isolation	DC - 1.0 GHz	22	25		dB
	DC - 2.0 GHz	20	24		dB
	DC - 2.5 GHz	17	21		dB
	DC - 3.0 GHz	13	17		dB
Return Loss	DC - 1.0 GHz	20	28		dB
	DC - 2.0 GHz	16	21		dB
	DC - 2.5 GHz	13	17		dB
	DC - 3.0 GHz	9	11		dB
Input Power for 1dB Compression	0/8V Control	0.5 - 1.0 GHz	35	39	dBm
		0.5 - 3.0 GHz	34	38	dBm
Input Third Order Intercept	0/8V Control	0.5 - 1.0 GHz	55	60	dBm
		0.5 - 3.0 GHz	55	60	dBm
Switching Characteristics	DC - 3.0 GHz	tRISE, tFALL (10/90% RF)	10		ns
		tON, tOFF (50% CTL to 10/90% RF)	24		ns

**Insertion Loss**

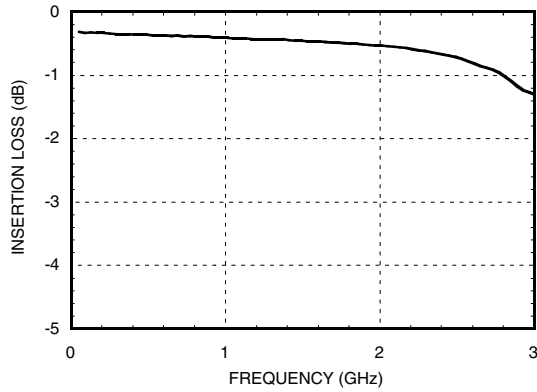

**Isolation**

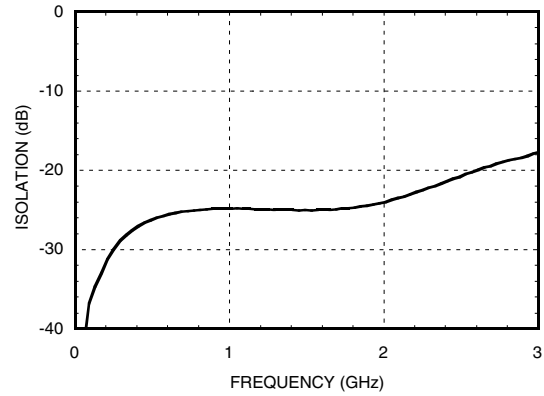

**Return Loss**

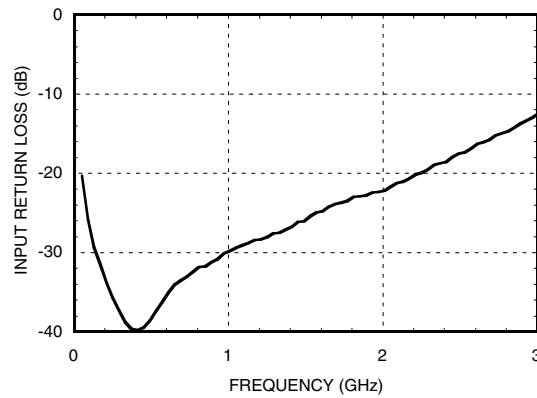

**Input 0.1 and 1.0 dB  
Compression vs. Bias Voltage**

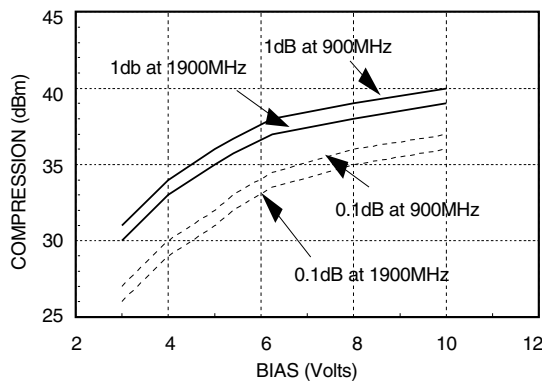

**Input Third Order  
Intercept vs. Bias Voltage**

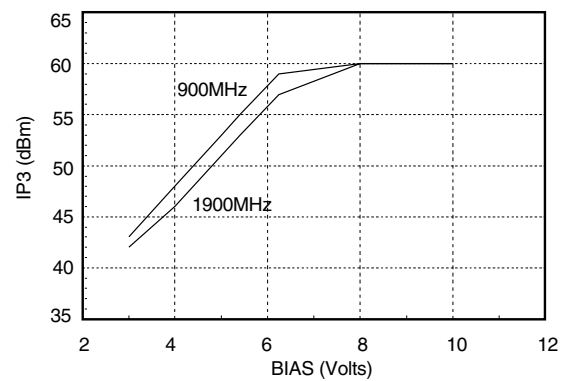

**Compression vs. Bias Voltages**

Bias Vdd	Carrier at 900 MHz		Carrier at 1900 MHz	
	Input Power for 0.1 dB Compression	Input Power for 1.0 dB Compression	Input Power for 0.1 dB Compression	Input Power for 1.0 dB Compression
	(dBm)	(dBm)	(dBm)	(dBm)
3	27	31	26	30
4	30	34	29	33
5	32	36	31	35
8	36	39	35	38
10	37	40	36	39

**Distortion vs. Bias Voltage**

Bias Vdd	1 Watt Carrier at 900 MHz			1 Watt Carrier at 1900 MHz		
	Third Order Intercept	Second Order Intercept	Second Harmonic	Third Order Intercept	Second Order Intercept	Second Harmonic
	(dBm)	(dBm)	(dBc)	(dBm)	(dBm)	(dBc)
3	43	71	45	42	78	55
4	48	85	55	46	88	65
5	53	90	56	51	87	58
8	60	90	58	60	90	59
10	60	90	59	60	90	60

**Caution:** Do not operate in 1dB compression at power levels above +35dBm and do not 'hot switch' power levels greater than +23dBm ( $V_{dd} = +5Vdc$ ).

**Truth Table**

**\*Control Input Voltage Tolerances are  $\pm 0.2 Vdc$**

Bias Vdd (Vdc)	Control Input*		Bias Current Idd (uA)	Control Current Ia (uA)	Control Current Ib (uA)	Signal Path State	
	A (Vdc)	B (Vdc)				RF to RF1	RF to RF2
3	0	0	30	-15	-15	OFF	OFF
3	0	Vdd	25	-25	0	ON	OFF
3	Vdd	0	25	0	-25	OFF	ON
5	0	0	110	-55	-55	OFF	OFF
5	0	Vdd	115	-100	-15	ON	OFF
5	Vdd	0	115	-15	-100	OFF	ON
10	0	0	380	-190	-190	OFF	OFF
10	0	Vdd	495	-275	-220	ON	OFF
10	Vdd	0	495	-220	-275	OFF	ON
5	-Vdd	Vdd	600	-600	225	ON	OFF
5	Vdd	-Vdd	600	225	-600	OFF	ON

### Absolute Maximum Ratings

Bias Voltage Range (Vdd)	-0.2 to +12 Vdc
Control Voltage Range (A & B)	-0.2 to +Vdd Vdc
Storage Temperature	-65 to +150 °C
Operating Temperature	-40 to +85 °C

### Outline Drawing

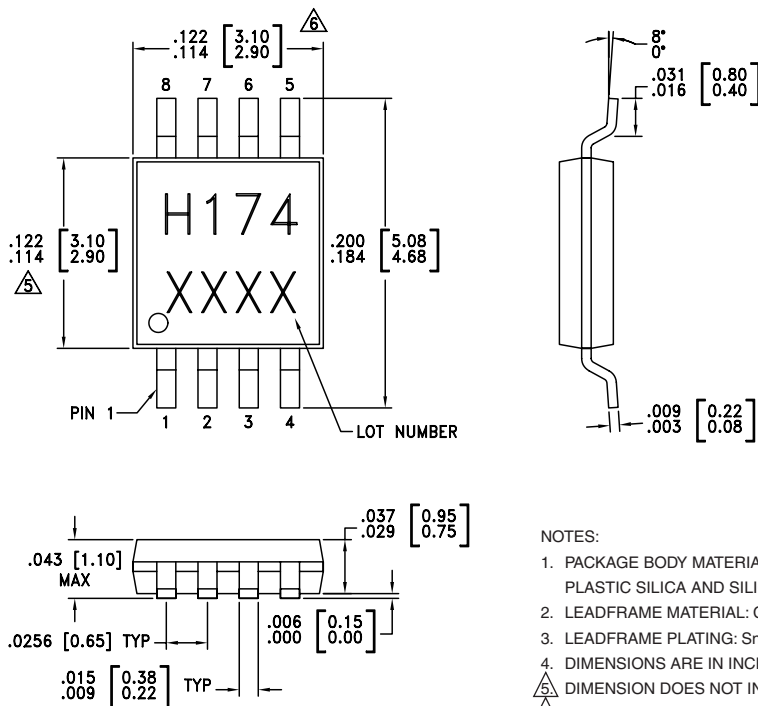

#### NOTES:

1. PACKAGE BODY MATERIAL: LOW STRESS INJECTION MOLDED PLASTIC SILICA AND SILICON IMPREGNATED.
2. LEADFRAME MATERIAL: COPPER ALLOY
3. LEADFRAME PLATING: Sn/Pb SOLDER
4. DIMENSIONS ARE IN INCHES (MILLIMETERS).
5.  $\triangle$  DIMENSION DOES NOT INCLUDE MOLDFLASH OF 0.15mm PER SIDE.
6.  $\triangle$  DIMENSION DOES NOT INCLUDE MOLDFLASH OF 0.25mm PER SIDE.
7. ALL GROUND LEADS MUST BE SOLDERED TO PCB RF GROUND.

### Typical Application Circuit

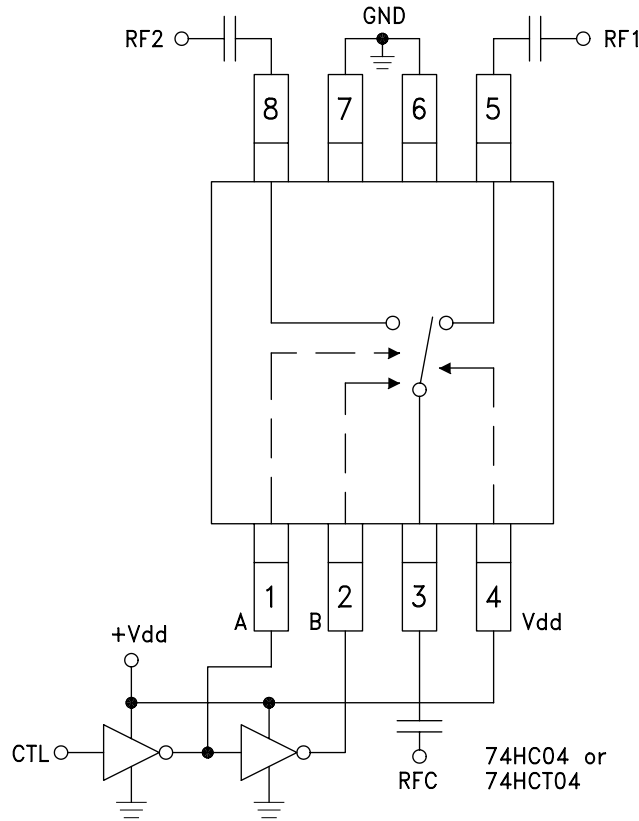

**Notes:**

1. Set logic gate and switch Vdd = +3V to +5V and use HCT series logic to provide a TTL driver interface.
2. Control inputs A/B can be driven directly with CMOS logic (HC) with Vdd of 3 to 8 Volts applied to the CMOS logic gates and to pin 4 of the RF switch.
3. DC Blocking capacitors are required for each RF port as shown. Capacitor value determines lowest frequency of operation.
4. Highest RF signal power capability is achieved with V set to +10V. The switch will operate properly (but at lower RF power capability) at bias voltages down to +3V.

### Evaluation Circuit Board

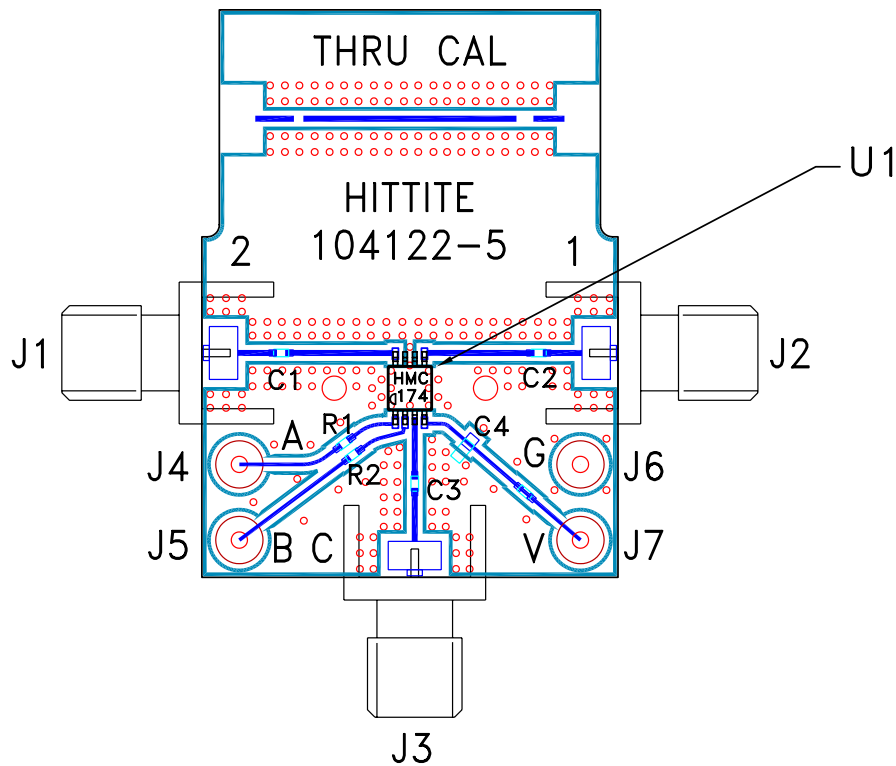

### List of Material

Item	Description
J1 - J3	PC Mount SMA RF Connector
J4 - J7	DC Pin
C1 - C3	100 pF capacitor, 0402 Pkg.
C4	10,000 pF capacitor, 0603 Pkg.
U1	HMC174MS8 T/R Switch
PCB*	104122 Evaluation PCB

\* Circuit Board Material: Rogers 4350

The circuit board used in the final application should be generated with proper RF circuit design techniques. Signal lines at the RF port should have 50 ohm impedance and the package ground leads and package bottom should be connected directly to the ground plane similar to that shown above. The evaluation circuit board shown above is available from Hittite Microwave Corporation upon request.