

**General Purpose High Current NPN Transistor Array**

The CA3083 is a versatile array of five high current (to 100mA) NPN transistors on a common monolithic substrate. In addition, two of these transistors (Q<sub>1</sub> and Q<sub>2</sub>) are matched at low current (i.e., 1mA) for applications in which offset parameters are of special importance.

Independent connections for each transistor plus a separate terminal for the substrate permit maximum flexibility in circuit design.

**Ordering Information**

PART NUMBER (BRAND)	TEMP. RANGE (°C)	PACKAGE	PKG. NO.
CA3083	-55 to 125	16 Ld PDIP	E16.3
CA3083M (3083)	-55 to 125	16 Ld SOIC	M16.15
CA3083M96 (3083)	-55 to 125	16 Ld SOIC Tape and Reel	M16.15

**Pinout**

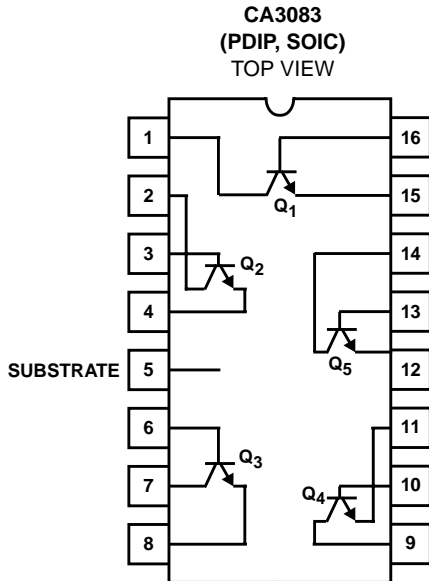

**Features**

- High I<sub>C</sub> . . . . . 100mA (Max)
- Low V<sub>CE sat</sub> (at 50mA) . . . . . 0.7V (Max)
- Matched Pair (Q<sub>1</sub> and Q<sub>2</sub>)
  - V<sub>IO</sub> (V<sub>BE</sub> Match) . . . . . ±5mV (Max)
  - I<sub>IO</sub> (at 1mA) . . . . . 2.5µA (Max)
- 5 Independent Transistors Plus Separate Substrate Connection

**Applications**

- Signal Processing and Switching Systems Operating from DC to VHF
- Lamp and Relay Driver
- Differential Amplifier
- Temperature Compensated Amplifier
- Thyristor Firing
- See Application Note AN5296 "Applications of the CA3018 Circuit Transistor Array" for Suggested Applications

**Absolute Maximum Ratings**

The following ratings apply for each transistor in the device:  
 Collector-to-Emitter Voltage,  $V_{CEO}$  ..... 15V  
 Collector-to-Base Voltage,  $V_{CBO}$  ..... 20V  
 Collector-to-Substrate Voltage,  $V_{CIO}$  (Note 1) ..... 20V  
 Emitter-to-Base Voltage,  $V_{EBO}$  ..... 5V  
 Collector Current ( $I_C$ ) ..... 100mA  
 Base Current ( $I_B$ ) ..... 20mA

**Thermal Information**

Thermal Resistance (Typical, Note 2)  $\theta_{JA}$  ( $^{\circ}C/W$ )  $\theta_{JC}$  ( $^{\circ}C/W$ )  
 PDIP Package ..... 135 N/A  
 SOIC Package ..... 200 N/A  
 Maximum Power Dissipation (Any One Transistor) ..... 500mW  
 Maximum Junction Temperature (Plastic Package) ..... 150 $^{\circ}C$   
 Maximum Storage Temperature Range ..... -65 $^{\circ}C$  to 150 $^{\circ}C$   
 Maximum Lead Temperature (Soldering 10s) ..... 300 $^{\circ}C$   
 (SOIC - Lead Tips Only)

**Operating Conditions**

Temperature Range ..... -55 $^{\circ}C$  to 125 $^{\circ}C$

*CAUTION: Stresses above those listed in "Absolute Maximum Ratings" may cause permanent damage to the device. This is a stress only rating and operation of the device at these or any other conditions above those indicated in the operational sections of this specification is not implied.*

**NOTES:**

1. The collector of each transistor of the CA3083 is isolated from the substrate by an integral diode. The substrate must be connected to a voltage which is more negative than any collector voltage in order to maintain isolation between transistors and provide normal transistor action. To avoid undesired coupling between transistors, the substrate Terminal (5) should be maintained at either DC or signal (AC) ground. A suitable bypass capacitor can be used to establish a signal ground.
2.  $\theta_{JA}$  is measured with the component mounted on an evaluation PC board in free air.

**Electrical Specifications** For Equipment Design,  $T_A = 25^{\circ}C$

PARAMETER	SYMBOL	TEST CONDITIONS	MIN	TYP	MAX	UNITS	
<b>FOR EACH TRANSISTOR</b>							
Collector-to-Base Breakdown Voltage	$V_{(BR)CBO}$	$I_C = 100\mu A, I_E = 0$	20	60	-	V	
Collector-to-Emitter Breakdown Voltage	$V_{(BR)CEO}$	$I_C = 1mA, I_B = 0$	15	24	-	V	
Collector-to-Substrate Breakdown Voltage	$V_{(BR)CIO}$	$I_{CI} = 100\mu A, I_B = 0, I_E = 0$	20	60	-	V	
Emitter-to-Base Breakdown Voltage	$V_{(BR)EBO}$	$I_E = 500\mu A, I_C = 0$	5	6.9	-	V	
Collector-Cutoff-Current	$I_{CEO}$	$V_{CE} = 10V, I_B = 0$	-	-	10	$\mu A$	
Collector-Cutoff-Current	$I_{CBO}$	$V_{CB} = 10V, I_E = 0$	-	-	1	$\mu A$	
DC Forward-Current Transfer Ratio (Note 3) (Figure 1)	$h_{FE}$	$V_{CE} = 3V$	$I_C = 10mA$	40	76	-	
			$I_C = 50mA$	40	75	-	
Base-to-Emitter Voltage (Figure 2)	$V_{BE}$	$V_{CE} = 3V, I_C = 10mA$	0.65	0.74	0.85	V	
Collector-to-Emitter Saturation Voltage (Figures 3, 4)	$V_{CE SAT}$	$I_C = 50mA, I_B = 5mA$	-	0.40	0.70	V	
Gain Bandwidth Product	$f_T$	$V_{CE} = 3V, I_C = 10mA$	-	450	-	MHz	
<b>FOR TRANSISTORS Q<sub>1</sub> AND Q<sub>2</sub> (As a Differential Amplifier)</b>							
Absolute Input Offset Voltage (Figure 6)	$ V_{IO} $	$V_{CE} = 3V, I_C = 1mA$	-	1.2	5	mV	
Absolute Input Offset Current (Figure 7)	$ I_{IO} $	$V_{CE} = 3V, I_C = 1mA$	-	0.7	2.5	$\mu A$	

**NOTE:**

3. Actual forcing current is via the emitter for this test.

Typical Performance Curves

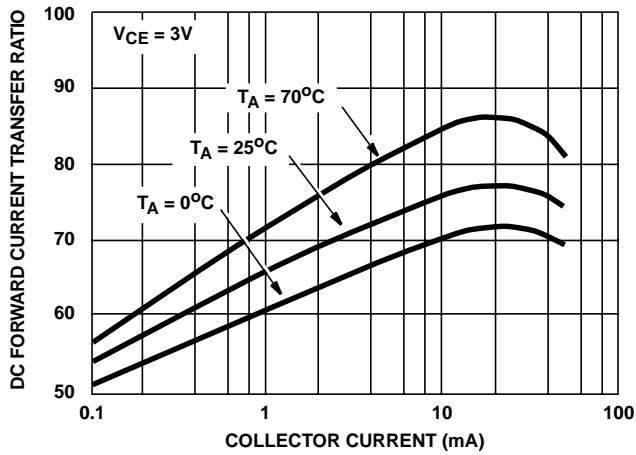

FIGURE 1.  $h_{FE}$  vs  $I_C$

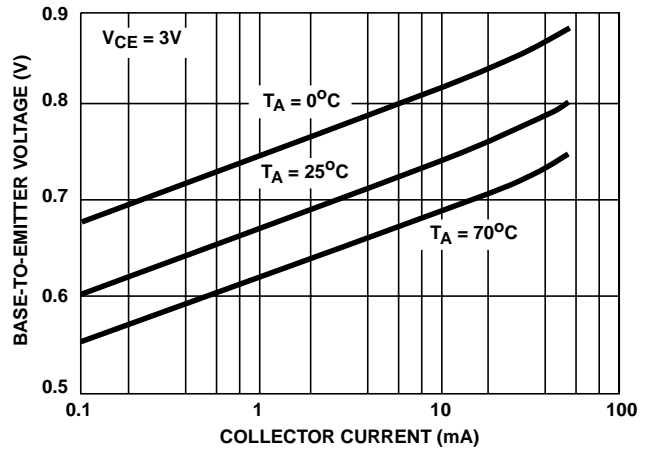

FIGURE 2.  $V_{BE}$  vs  $I_C$

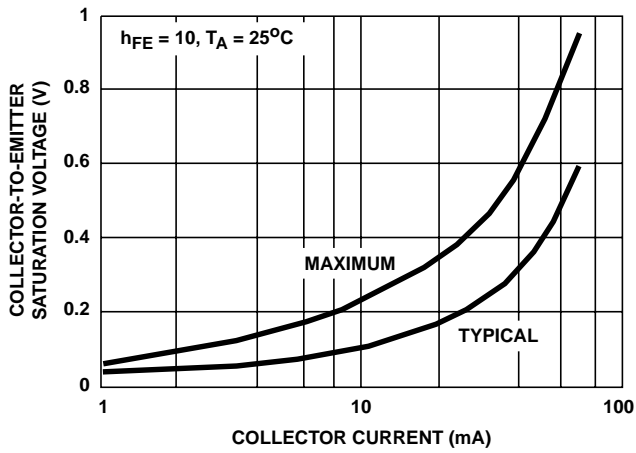

FIGURE 3.  $V_{CE SAT}$  vs  $I_C$

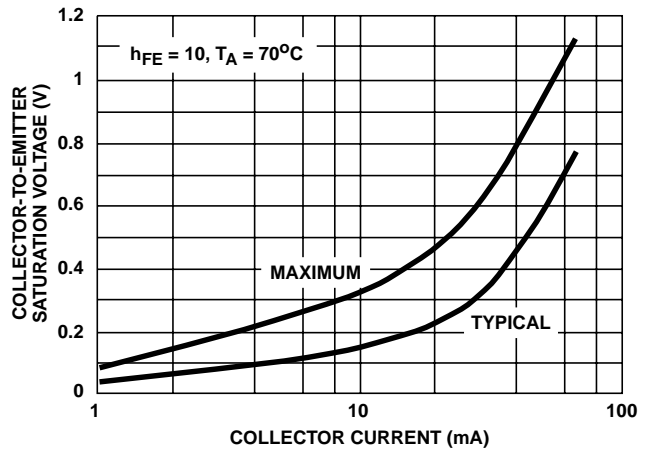

FIGURE 4.  $V_{CE SAT}$  vs  $I_C$

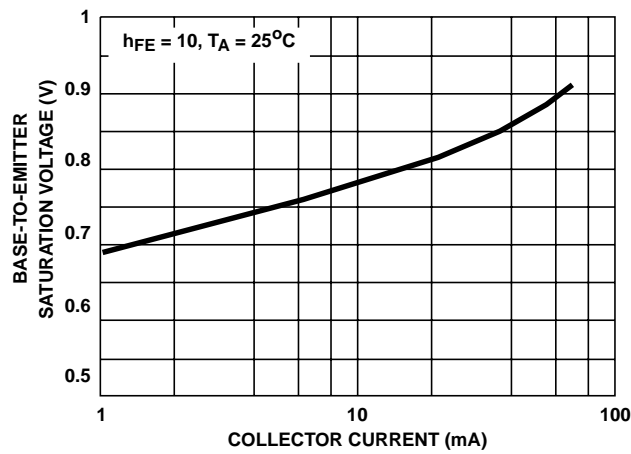

FIGURE 5.  $V_{BE SAT}$  vs  $I_C$

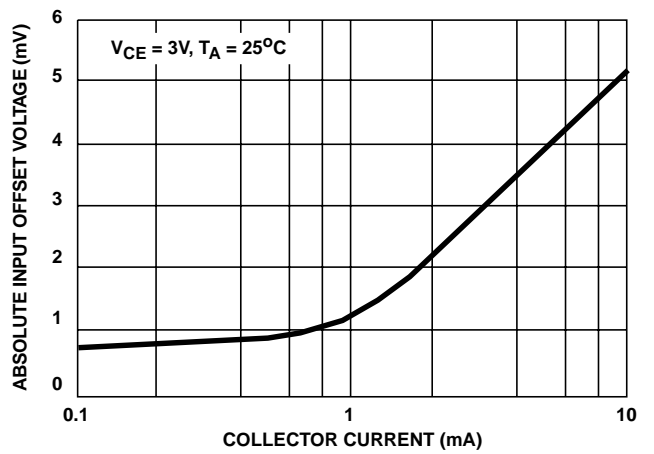

FIGURE 6.  $V_{IO}$  vs  $I_C$  (TRANSISTORS  $Q_1$  AND  $Q_2$  AS A DIFFERENTIAL AMPLIFIER)

## Typical Performance Curves (Continued)

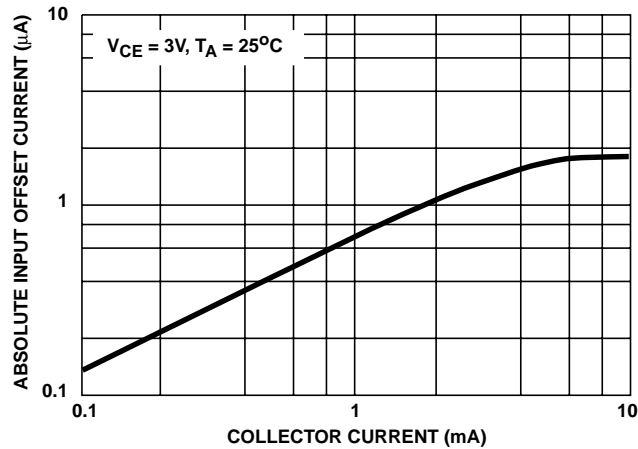

FIGURE 7.  $I_O$  vs  $I_C$  (TRANSISTORS  $Q_1$  AND  $Q_2$  AS A DIFFERENTIAL AMPLIFIER)

All Intersil semiconductor products are manufactured, assembled and tested under **ISO9000** quality systems certification.

*Intersil semiconductor products are sold by description only. Intersil Corporation reserves the right to make changes in circuit design and/or specifications at any time without notice. Accordingly, the reader is cautioned to verify that data sheets are current before placing orders. Information furnished by Intersil is believed to be accurate and reliable. However, no responsibility is assumed by Intersil or its subsidiaries for its use; nor for any infringements of patents or other rights of third parties which may result from its use. No license is granted by implication or otherwise under any patent or patent rights of Intersil or its subsidiaries.*

For information regarding Intersil Corporation and its products, see web site [www.intersil.com](http://www.intersil.com)

### Sales Office Headquarters

#### NORTH AMERICA

Intersil Corporation  
P. O. Box 883, Mail Stop 53-204  
Melbourne, FL 32902  
TEL: (321) 724-7000  
FAX: (321) 724-7240

#### EUROPE

Intersil SA  
Mercure Center  
100, Rue de la Fusee  
1130 Brussels, Belgium  
TEL: (32) 2.724.2111  
FAX: (32) 2.724.22.05

#### ASIA

Intersil (Taiwan) Ltd.  
7F-6, No. 101 Fu Hsing North Road  
Taipei, Taiwan  
Republic of China  
TEL: (886) 2 2716 9310  
FAX: (886) 2 2715 3029