

BIPOLAR ANALOG INTEGRATED CIRCUITS

μ PC2747TB, μ PC2748TB

3 V, SUPER MINIMOLD SILICON MMIC AMPLIFIER FOR MOBILE COMMUNICATIONS

DESCRIPTION

The μ PC2747TB, μ PC2748TB are silicon monolithic integrated circuits designed as amplifier for mobile communications. These ICs are packaged in super minimold package which is smaller than conventional minimold.

The μ PC2747TB, μ PC2748TB have compatible pin connections and performance to μ PC2747T, μ PC2748T of conventional minimold version. So, in the case of reducing your system size, μ PC2747TB, μ PC2748TB are suitable to replace from μ PC2747T, μ PC2748T.

These ICs are manufactured using NEC's 20 GHz fr NESAT™ III silicon bipolar process. This process uses silicon nitride passivation film and gold electrodes. These materials can protect chip surface from external pollution and prevent corrosion/migration. Thus, these ICs have excellent performance, uniformity and reliability.

FEATURES

- High-density surface mounting : 6-pin super minimold package
- Supply voltage : $V_{CC} = 2.7$ to 3.3 V
- Noise figure : μ PC2747TB ; NF = 3.3 dB TYP. @ $f = 900$ MHz
: μ PC2748TB ; NF = 2.8 dB TYP. @ $f = 900$ MHz
- Upper limit operating frequency : μ PC2747TB ; $f_u = 1.8$ GHz TYP.
: μ PC2748TB ; $f_u = 1.5$ GHz TYP.

APPLICATION

- Buffer amplifiers for mobile telephones, etc. (PDC800M, GSM)

ORDERING INFORMATION

Part Number	Package	Marking	Supplying Form
μ PC2747TB-E3	6-pin super minimold	C1S	Embossed tape 8 mm wide. 1, 2, 3 pins face to perforation side of the tape. Qty 3 kp/reel.
μ PC2748TB-E3		C1T	

Remark To order evaluation samples, please contact your local NEC sales office. (Part number for sample order: μ PC2747TB, μ PC2748TB)

Caution Electro-static sensitive devices

The information in this document is subject to change without notice. Before using this document, please confirm that this is the latest version.

Not all devices/types available in every country. Please check with local NEC representative for availability and additional information.

PIN CONNECTIONS

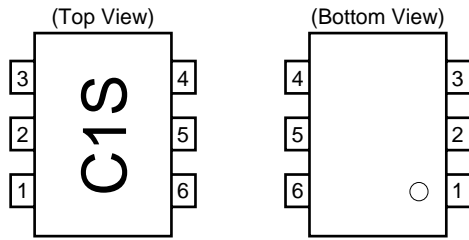

Pin No.	Pin Name
1	INPUT
2	GND
3	GND
4	OUTPUT
5	GND
6	V _{cc}

Marking is an example of μ PC2747TB

PRODUCT LINE-UP (T_A = +25°C, V_{cc} = 3.0 V, Z_L = Z_s = 50 Ω)

Part No.	f _u (GHz)	P _{O(sat)} (dBm)	G _P (dB)	NF (dB)	I _{cc} (mA)	Package	Marking
μ PC2747T	1.8	-7.0	12	3.3	5.0	6-pin minimold	C1S
μ PC2747TB						6-pin super minimold	
μ PC2748T	0.2 to 1.5	-3.5	19	2.8	6.0	6-pin minimold	C1T
μ PC2748TB						6-pin super minimold	

Remark Typical performance. Please refer to **ELECTRICAL CHARACTERISTICS** in detail.

Notice The package size distinguishes between minimold and super minimold.

SYSTEM APPLICATION EXAMPLE

EXAMPLE OF 900 MHz BAND DIGITAL CELLULER TELEPHONE

Digital Cellular System Block Diagram

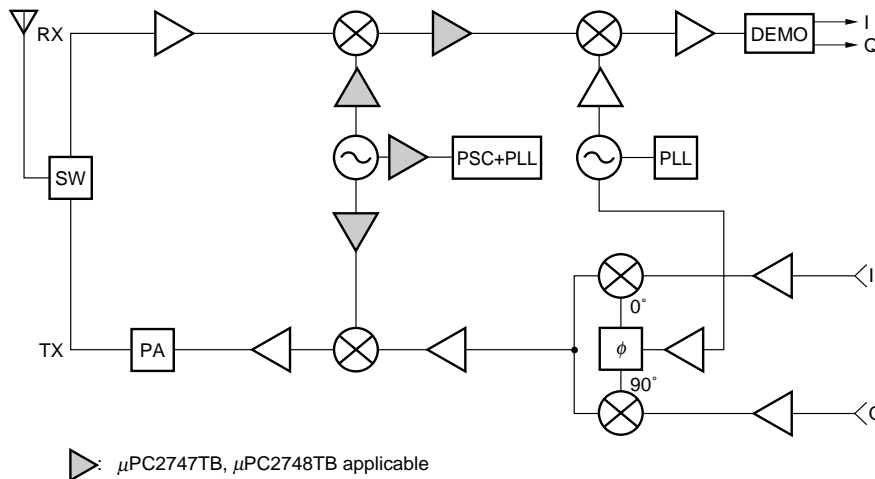

PIN EXPLANATION

Pin No.	Pin Name	Applied Voltage (V)	Pin Voltage (V) ^{Note}	Function and Applications	Internal Equivalent Circuit
1	INPUT	—	0.80 ----- 0.80	Signal input pin. A internal matching circuit, configured with resistors, enables 50 Ω connection over a wide band. This pin must be coupled to signal source with capacitor for DC cut.	<p>The above diagram is for the μPC2747TB. The resistor marked with an asterisk does not exist in the μPC2748TB.</p>
4	OUTPUT	—	2.79 ----- 2.72	Signal output pin. A internal matching circuit, configured with resistors, enables 50 Ω connection over a wide band. This pin must be coupled to next stage with capacitor for DC cut.	
6	V _{CC}	2.7 to 3.3	—	Power supply pin. This pin should be externally equipped with bypass capacity to minimize ground impedance.	
2 3 5	GND	0	—	Ground pin. This pin should be connected to system ground with minimum inductance. Ground pattern on the board should be formed as wide as possible. All the ground pins must be connected together with wide ground pattern to decrease impedance difference.	

Note Pin voltage is measured at V_{CC} = 3.0 V. Above: μ PC2747TB, Below: μ PC2748TB

ABSOLUTE MAXIMUM RATINGS

Parameter	Symbol	Conditions	Ratings	Unit
Supply Voltage	V _{CC}	T _A = +25°C	4.0	V
Circuit Current	I _{CC}	T _A = +25°C	15	mA
Power Dissipation	P _D	Mounted on double sided copper clad 50 × 50 × 1.6 mm epoxy glass PWB (T _A = +85°C)	200	mW
Operating Ambient Temperature	T _A		-40 to +85	°C
Storage Temperature	T _{stg}		-55 to +150	°C
Input Power Level	P _{in}	T _A = +25°C	0	dBm

RECOMMENDED OPERATING CONDITIONS

Parameter	Symbol	MIN.	TYP.	MAX.	Unit
Supply Voltage	V _{CC}	2.7	3.0	3.3	V
Operating Ambient Temperature	T _A	-40	+25	+85	°C

ELECTRICAL CHARACTERISTICS (T_A = +25°C, V_{CC} = 3.0 V, Z_S = Z_L = 50 Ω)

Parameter	Symbol	Test Conditions	μ PC2747TB			μ PC2748TB			Unit
			MIN.	TYP.	MAX.	MIN.	TYP.	MAX.	
Circuit Current	I _{CC}	No Signal	3.8	5.0	7.0	4.5	6.0	8.0	mA
Power Gain	G _P	f = 900 MHz	9	12	14	16	19	21	dB
Maximum Output Level	P _{O(sat)}	f = 900 MHz P _{in} = -8 dBm	-9.5	-7.0	-	-6.0	-3.5	-	dBm
Noise Figure	NF	f = 900 MHz	-	3.3	4.5	-	2.8	4.0	dB
Upper Limit Operating Frequency	f _u	3 dB down below from gain at f = 900 MHz	1.5	1.8	-	1.2	1.5	-	GHz
Lower Limit Operating Frequency	f _l	3 dB down below from gain at f = 900 MHz	-	-	-	-	0.2	0.4	GHz
Isolation	ISL	f = 900 MHz	35	40	-	35	40	-	dB
Input Return Loss	RL _{in}	f = 900 MHz	11	14	-	8.5	11.5	-	dB
Output Return Loss	RL _{out}	f = 900 MHz	7	10	-	5.5	8.5	-	dB

STANDARD CHARACTERISTICS FOR REFERENCE ($T_A = +25\text{ }^\circ\text{C}$, $Z_L = Z_S = 50\ \Omega$)

Parameter	Symbol	Test Conditions	Reference		Unit
			μ PC2747TB	μ PC2748TB	
Circuit Current	I_{CC}	$V_{CC} = 1.8\text{ V}$, No signals	3.0	3.5	mA
Power Gain	G_P	$V_{CC} = 1.8\text{ V}$, $f = 900\text{ MHz}$	5.5	11.5	dB
Maximum Output Level	$P_{O(sat)}$	$V_{CC} = 1.8\text{ V}$, $f = 900\text{ MHz}$, $P_{in} = -8\text{ dBm}$	-13.7	-10.0	dBm
Noise Figure	NF	$V_{CC} = 1.8\text{ V}$, $f = 900\text{ MHz}$	5.2	4.5	dB
Upper Limit Operating Frequency	f_u	$V_{CC} = 1.8\text{ V}$, 3 dB down below from gain at $f = 900\text{ MHz}$	1.8	1.5	GHz
Lower Limit Operating Frequency	f_L	$V_{CC} = 1.8\text{ V}$, 3 dB down below from gain at $f = 900\text{ MHz}$	—	0.2	GHz
Isolation	ISL	$V_{CC} = 1.8\text{ V}$, $f = 900\text{ MHz}$	34	34	dB
Input Return Loss	RL_{in}	$V_{CC} = 1.8\text{ V}$, $f = 900\text{ MHz}$	11	10	dB
Output Return Loss	RL_{out}	$V_{CC} = 1.8\text{ V}$, $f = 900\text{ MHz}$	13	12	dB
3rd Order Intermodulation Distortion	IM_3	$V_{CC} = 3.0\text{ V}$, $P_{out} = -20\text{ dBm}$, $f_1 = 900\text{ MHz}$, $f_2 = 902\text{ MHz}$	-34	-38	dBc
		$V_{CC} = 1.8\text{ V}$, $P_{out} = -20\text{ dBm}$, $f_1 = 900\text{ MHz}$, $f_2 = 902\text{ MHz}$	-20	-28	

TEST CIRCUIT

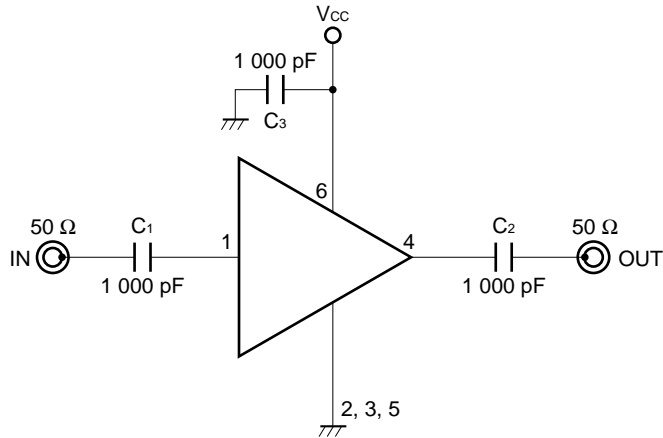

EXAMPLE OF APPLICATION CIRCUIT

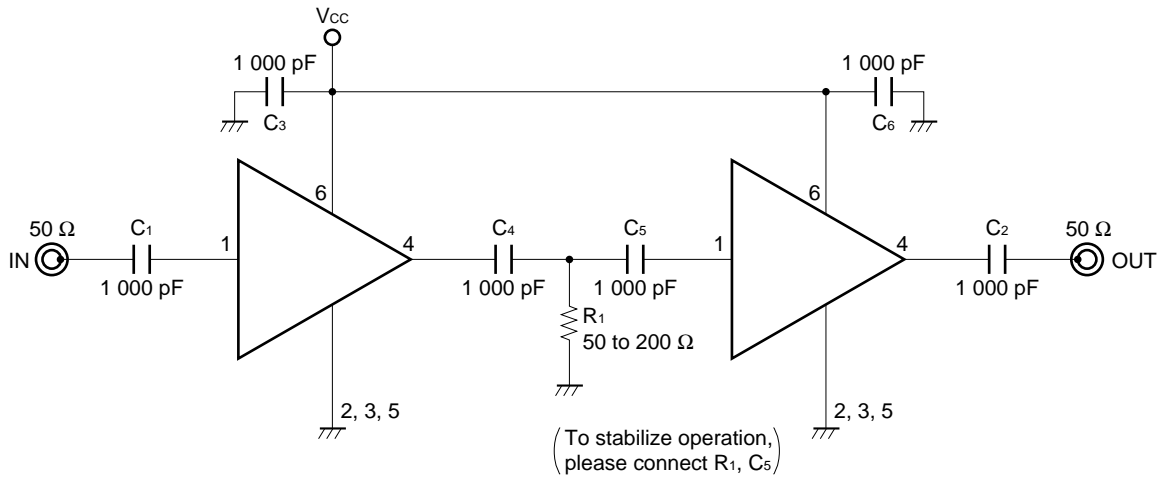

The application circuits and their parameters are for reference only and are not intended for use in actual design-ins.

Capacitors for Vcc, input and output pins

1 000 pF capacitors are recommendable as bypass capacitor for Vcc pin and coupling capacitors for input/output pins.

Bypass capacitor for Vcc pin is intended to minimize Vcc pin's ground impedance. Therefore, stable bias can be supplied against Vcc fluctuation.

Coupling capacitors for input/output pins are intended to minimize RF serial impedance and cut DC.

To get flat gain from 100 MHz up, 1 000 pF capacitors are assembled on the test circuit. [Actually, 1 000 pF capacitors give flat gain at least 10 MHz. In the case of under 10 MHz operation, increase the value of coupling capacitor such as 2 200 pF. Because the coupling capacitors are determined by the equation of $C = 1/(2 \pi fZ_s)$.]

ILLUSTRATION OF THE TEST CIRCUIT ASSEMBLED ON EVALUATION BOARD

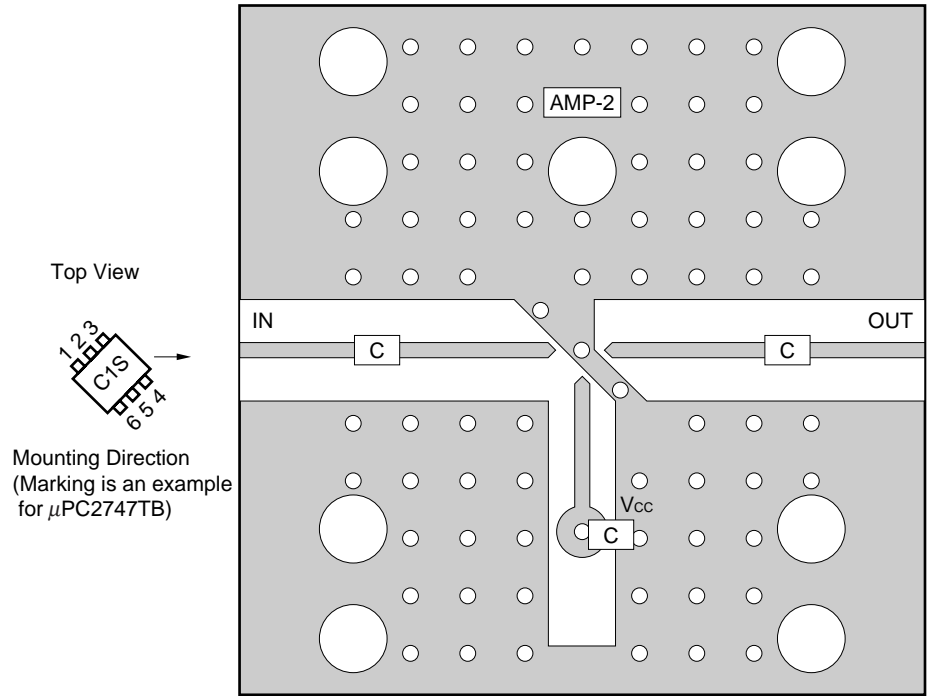

COMPONENT LIST

	Value
C	1 000 pF

Notes

1. 30 × 30 × 0.4 mm double sided copper clad polyimide board.
2. Back side: GND pattern
3. Solder plated on pattern
4. ○ ○ : Through holes

For more information on the use of this IC, refer to the following application note: USAGE AND APPLICATIONS OF 6-PIN MINI-MOLD, 6-PIN SUPER MINI-MOLD SILICON HIGH-FREQUENCY WIDEBAND AMPLIFIER MMIC (P11976E).

★ TYPICAL CHARACTERISTICS (Unless otherwise specified, $T_A = +25\text{ }^\circ\text{C}$)

– μ PC2747TB –

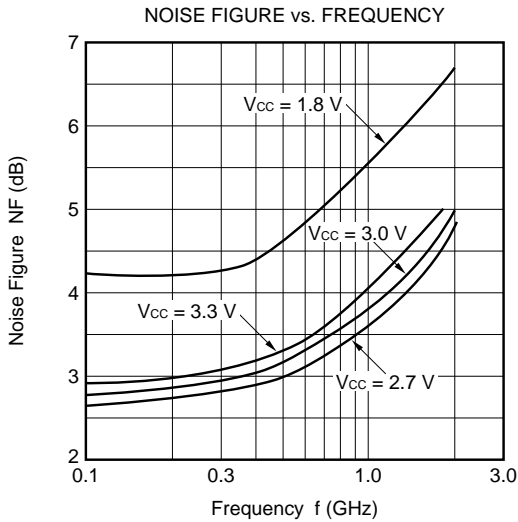
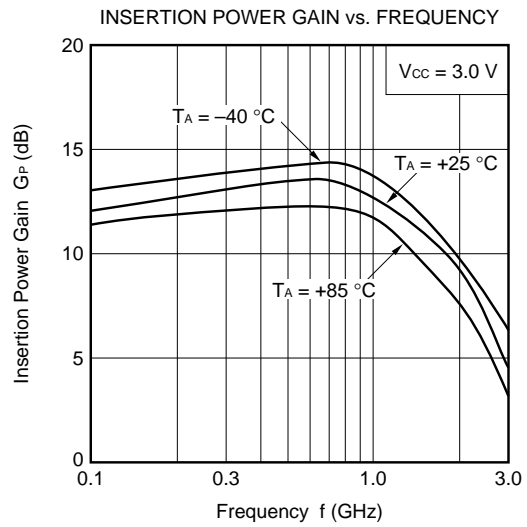
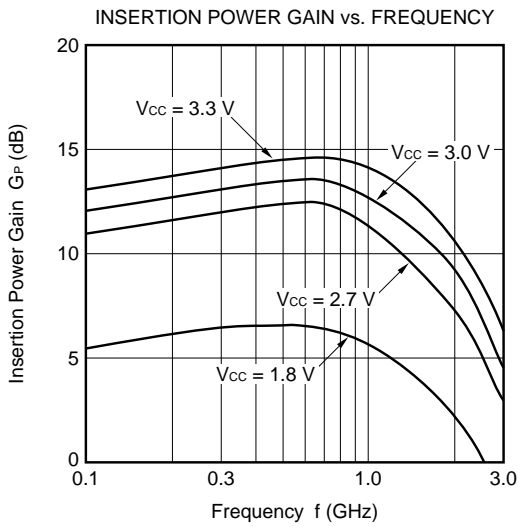
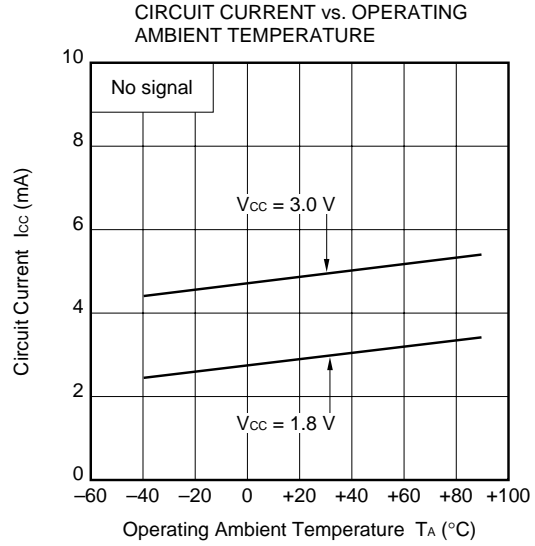
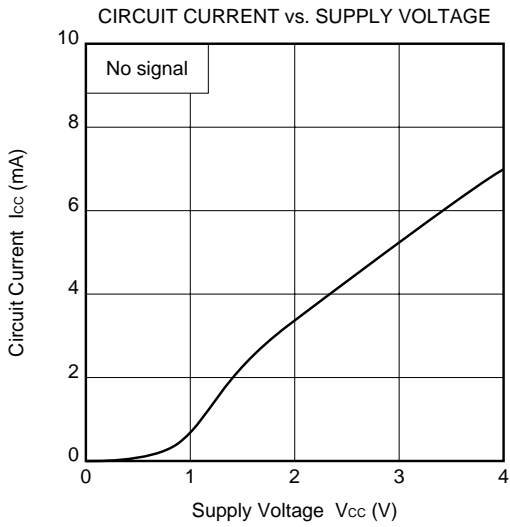

- μ PC2747TB -

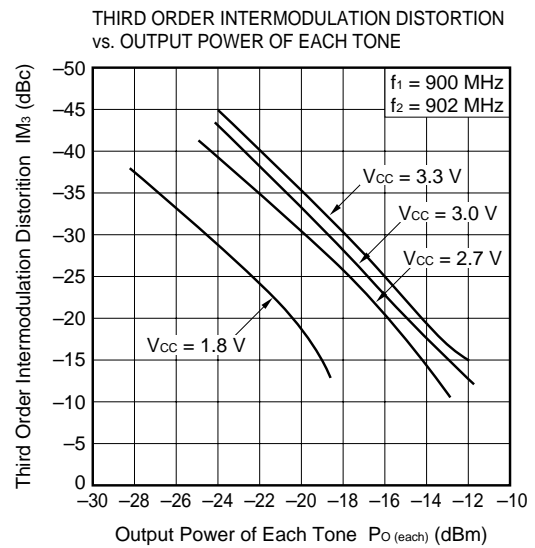
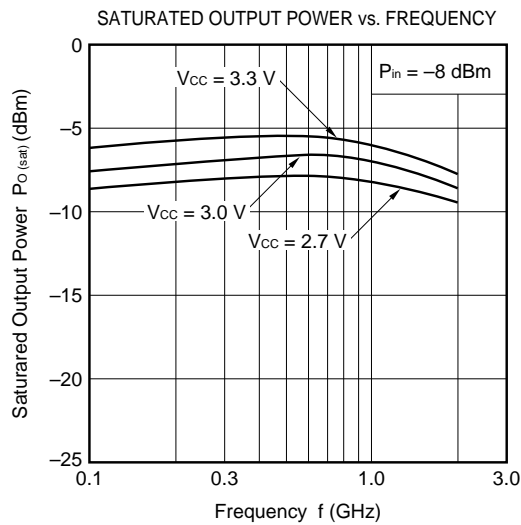
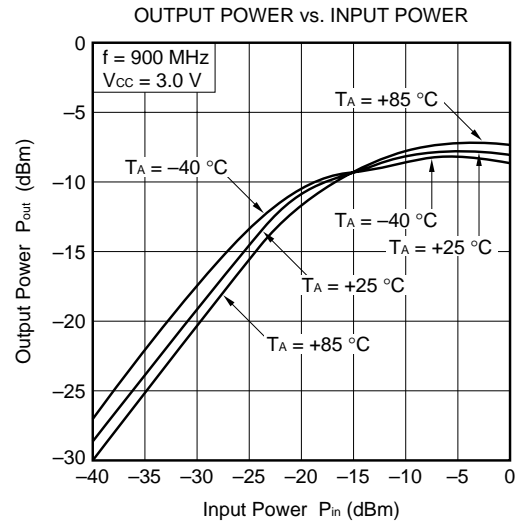
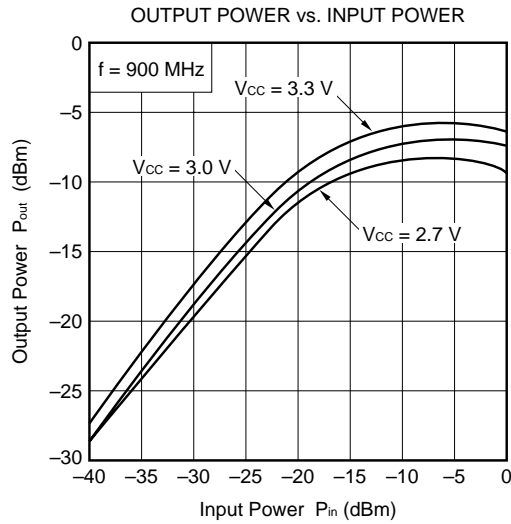
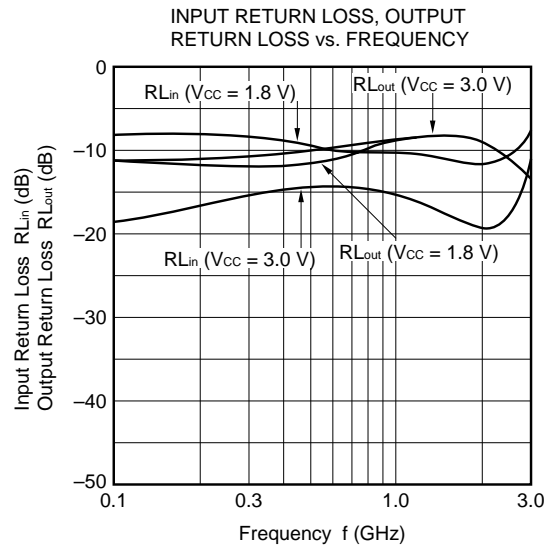
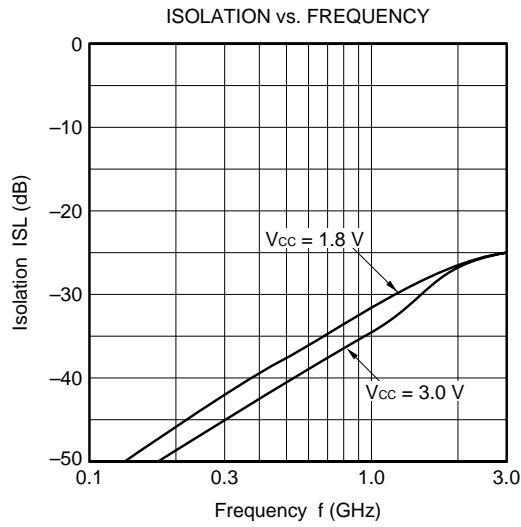

★ S-PARAMETER ($T_A = +25\text{ }^\circ\text{C}$, $V_{CC} = 3.0\text{ V}$)

– μ PC2747TB –

S₁₁-FREQUENCY

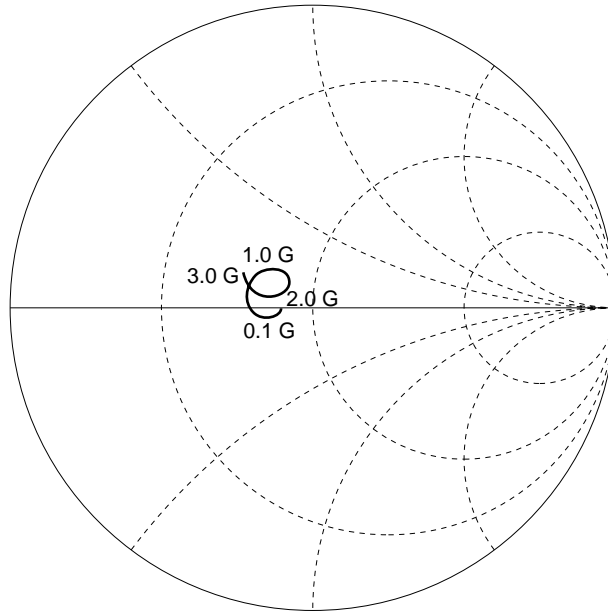

S₂₂-FREQUENCY

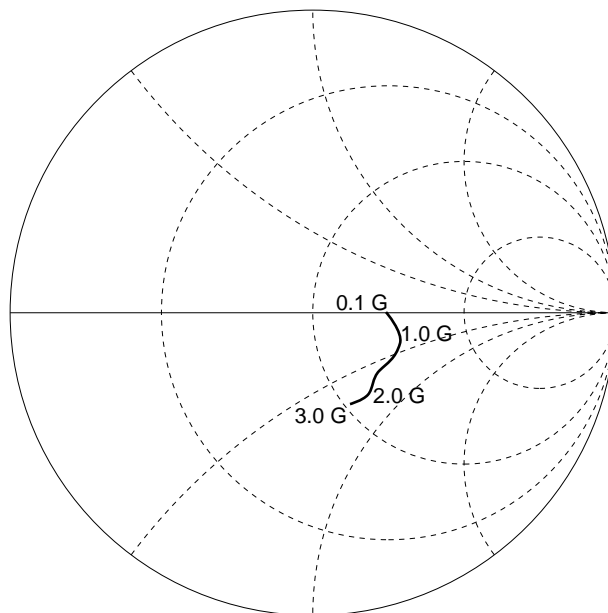

★ TYPICAL S-PARAMETER VALUES (T_A = +25 °C)

μPC2747TB

V_{CC} = 3.0 V, I_{CC} = 5.0 mA

FREQUENCY MHz	S ₁₁		S ₂₁		S ₁₂		S ₂₂		K
	MAG.	ANG.	MAG.	ANG.	MAG.	ANG.	MAG.	ANG.	
100.0000	0.091	-178.3	3.732	-3.9	0.001	28.0	0.290	-3.7	98.96
200.0000	0.105	-161.2	3.997	-13.3	0.002	103.2	0.294	-4.3	64.71
300.0000	0.136	-166.8	4.075	-23.4	0.002	76.0	0.292	-3.9	46.80
400.0000	0.165	-172.9	4.105	-32.9	0.004	90.4	0.286	-5.6	29.99
500.0000	0.179	177.8	4.141	-41.2	0.004	89.4	0.298	-6.9	25.94
600.0000	0.185	170.1	4.098	-49.5	0.005	90.7	0.302	-8.4	20.69
700.0000	0.189	162.5	4.124	-57.9	0.006	96.6	0.307	-10.2	17.38
800.0000	0.189	155.1	4.104	-66.3	0.008	101.3	0.309	-12.2	12.59
900.0000	0.182	148.8	4.061	-74.5	0.009	99.2	0.313	-14.4	12.26
1000.0000	0.180	142.6	4.016	-83.0	0.012	99.9	0.316	-16.9	9.45
1100.0000	0.174	137.1	3.977	-91.8	0.013	100.3	0.318	-19.7	8.22
1200.0000	0.160	131.5	3.948	-99.5	0.015	105.5	0.318	-22.6	7.49
1300.0000	0.148	127.4	3.799	-108.4	0.016	96.6	0.318	-24.9	7.42
1400.0000	0.134	124.4	3.736	-115.9	0.019	93.8	0.313	-27.4	6.36
1500.0000	0.124	121.0	3.582	-124.0	0.022	93.8	0.311	-30.1	5.83
1600.0000	0.110	121.0	3.506	-131.7	0.023	88.1	0.312	-31.8	5.55
1700.0000	0.099	122.9	3.317	-138.8	0.025	88.6	0.308	-33.3	5.37
1800.0000	0.089	126.8	3.190	-145.7	0.028	88.3	0.305	-35.1	5.05
1900.0000	0.084	134.8	3.040	-152.8	0.030	80.2	0.305	-37.2	4.98
2000.0000	0.085	141.7	2.901	-159.0	0.032	78.7	0.303	-38.8	4.97
2100.0000	0.087	148.1	2.736	-164.8	0.034	77.6	0.299	-40.9	4.99
2200.0000	0.092	152.1	2.645	-170.8	0.035	73.0	0.304	-41.5	4.97
2300.0000	0.102	156.6	2.507	-176.3	0.037	72.5	0.304	-42.2	4.93
2400.0000	0.114	158.7	2.395	177.8	0.038	68.5	0.305	-44.7	5.01
2500.0000	0.126	161.4	2.312	172.9	0.041	66.2	0.317	-45.8	4.76
2600.0000	0.136	160.6	2.218	168.1	0.042	64.0	0.319	-47.8	4.78
2700.0000	0.154	161.3	2.136	162.1	0.042	60.4	0.323	-50.8	4.88
2800.0000	0.168	160.4	2.036	157.8	0.044	54.8	0.331	-54.1	4.88
2900.0000	0.180	157.9	1.952	151.6	0.044	53.0	0.330	-57.5	5.07
3000.0000	0.196	155.2	1.847	147.6	0.043	47.2	0.332	-60.9	5.45
3100.0000	0.208	152.5	1.757	141.6	0.045	44.0	0.331	-65.5	5.49

★ TYPICAL CHARACTERISTICS (Unless otherwise specified, $T_A = +25\text{ }^\circ\text{C}$)

– μ PC2748TB –

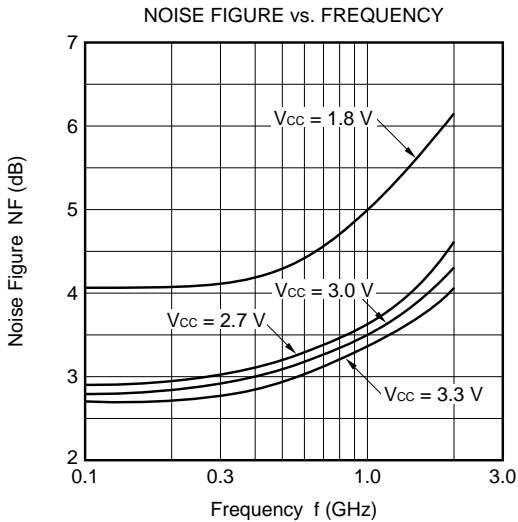
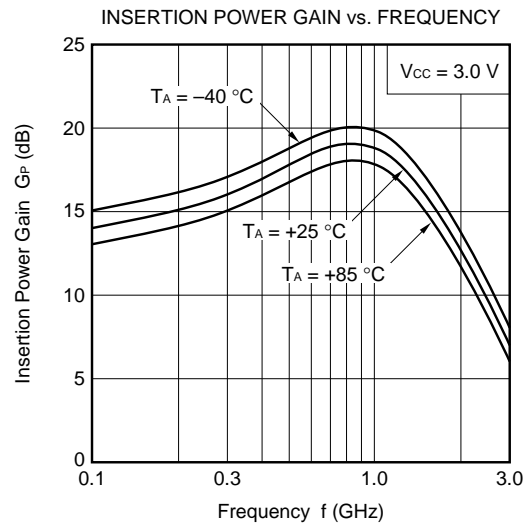
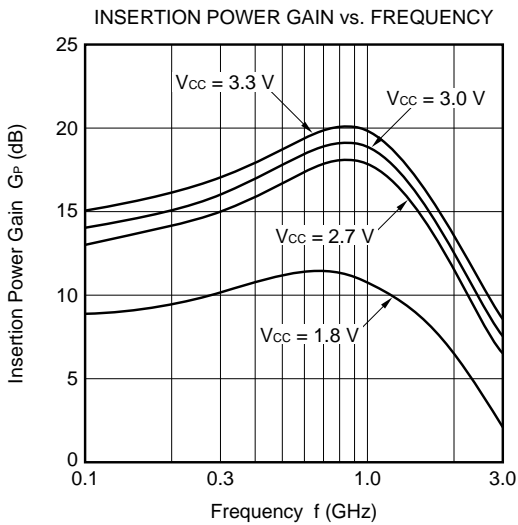
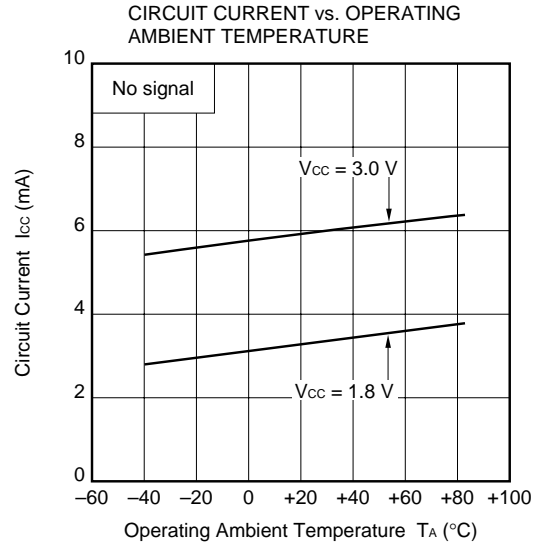
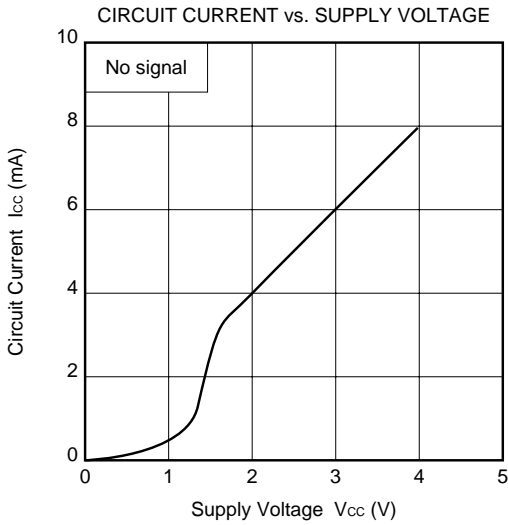

- μ PC2748TB -

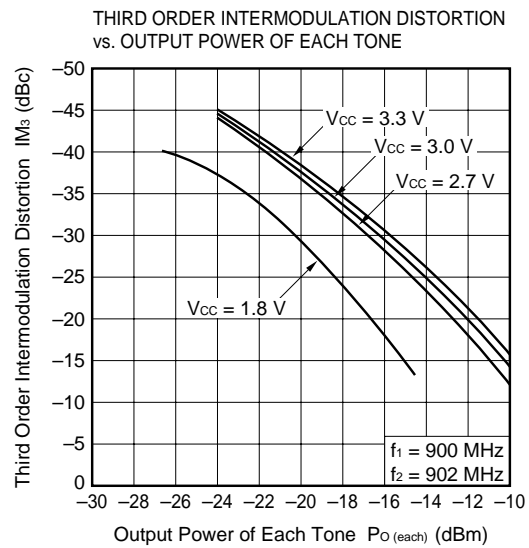
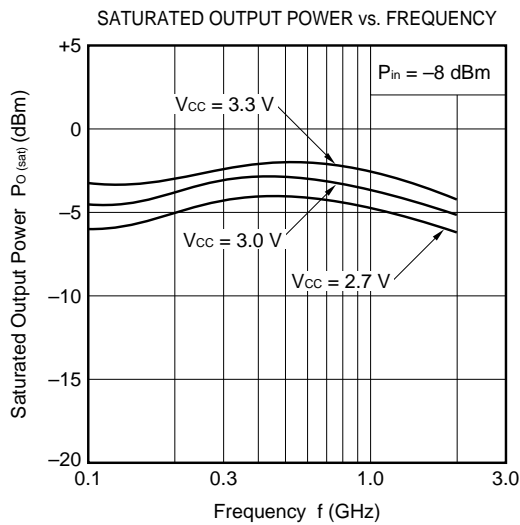
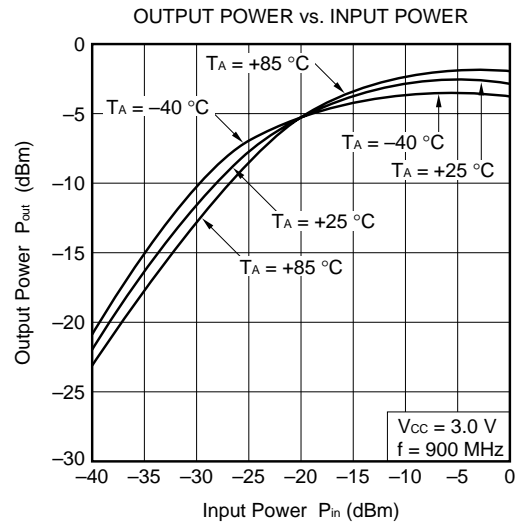
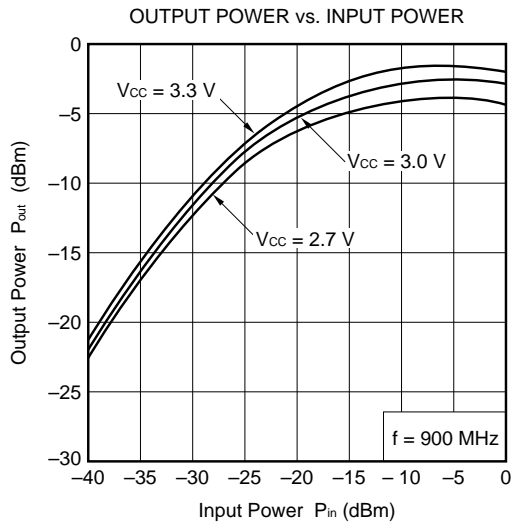
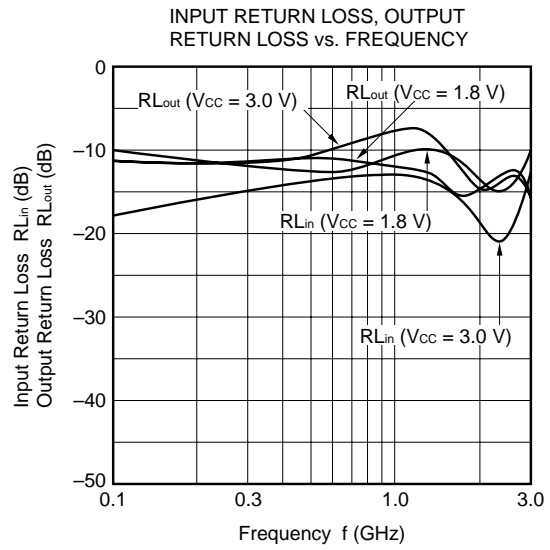
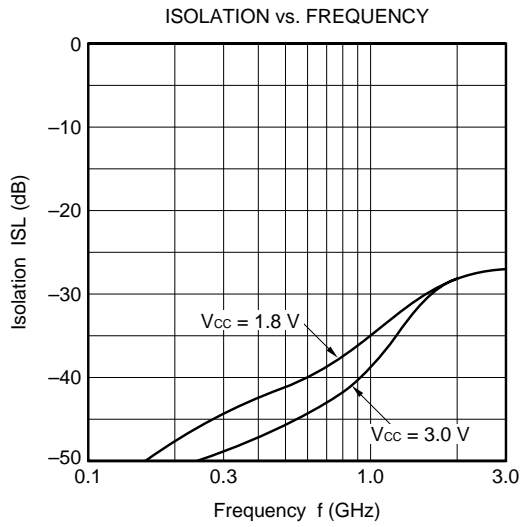

★ S-PARAMETER ($T_A = +25\text{ }^\circ\text{C}$, $V_{CC} = 3.0\text{ V}$)

– μ PC2748TB –

S₁₁-FREQUENCY

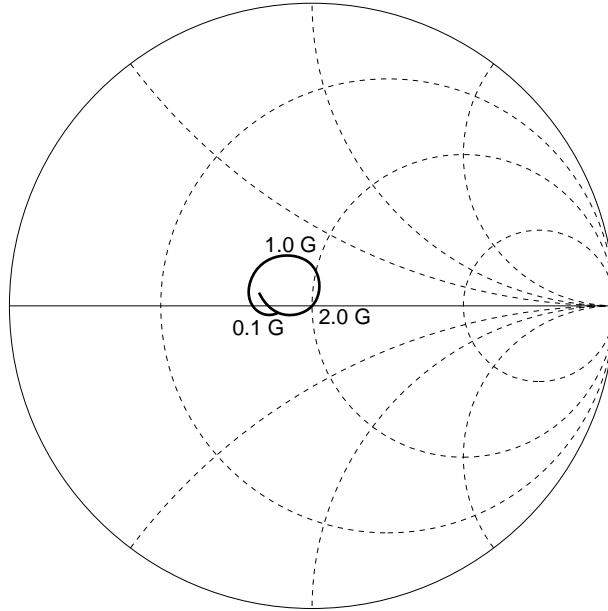

S₂₂-FREQUENCY

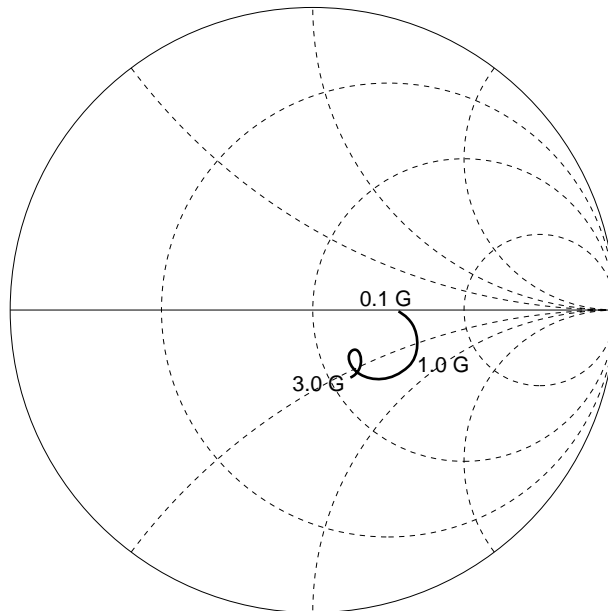

TYPICAL S-PARAMETER VALUES (T_A = +25 °C)

μPC2748TB

V_{CC} = 3.0 V, I_{CC} = 6.0 mA

FREQUENCY MHz	S ₁₁		S ₂₁		S ₁₂		S ₂₂		K
	MAG.	ANG.	MAG.	ANG.	MAG.	ANG.	MAG.	ANG.	
100.0000	0.120	-177.2	4.730	5.3	0.000	-30.4	0.280	-2.2	352.73
200.0000	0.136	-167.3	5.430	-0.2	0.001	19.3	0.285	-2.4	72.83
300.0000	0.166	-174.2	5.930	-9.2	0.001	97.8	0.286	-0.9	52.47
400.0000	0.194	179.6	6.314	-18.8	0.003	125.4	0.291	-2.7	24.77
500.0000	0.210	169.6	6.701	-28.2	0.004	108.7	0.306	-3.7	16.82
600.0000	0.213	160.0	6.876	-38.8	0.005	107.4	0.319	-5.4	12.40
700.0000	0.213	150.2	7.203	-49.3	0.006	98.7	0.337	-8.4	10.09
800.0000	0.211	140.8	7.310	-60.6	0.009	114.1	0.349	-12.3	6.68
900.0000	0.203	131.1	7.354	-71.5	0.010	107.6	0.360	-17.4	5.68
1000.0000	0.193	121.1	7.371	-81.9	0.012	98.3	0.371	-22.7	4.71
1100.0000	0.180	110.8	7.346	-92.8	0.014	99.1	0.366	-28.9	3.98
1200.0000	0.159	100.6	7.334	-102.4	0.015	97.5	0.359	-35.3	4.01
1300.0000	0.136	90.6	7.001	-112.6	0.016	91.4	0.342	-40.7	3.95
1400.0000	0.115	79.2	6.834	-121.3	0.018	84.1	0.320	-46.0	3.71
1500.0000	0.096	70.4	6.437	-130.1	0.019	84.8	0.296	-50.5	3.77
1600.0000	0.072	60.9	6.181	-138.2	0.020	82.4	0.271	-53.0	3.81
1700.0000	0.049	47.5	5.710	-145.4	0.020	78.9	0.247	-55.1	4.13
1800.0000	0.024	36.5	5.372	-152.5	0.021	73.5	0.228	-55.7	4.22
1900.0000	0.007	-6.0	5.014	-158.6	0.021	74.1	0.208	-55.7	4.57
2000.0000	0.014	-126.0	4.724	-164.1	0.024	74.9	0.198	-52.8	4.37
2100.0000	0.034	-141.3	4.405	-169.7	0.024	71.5	0.188	-52.1	4.70
2200.0000	0.047	-147.7	4.175	-174.7	0.026	73.6	0.190	-47.8	4.44
2300.0000	0.063	-156.9	3.933	-179.5	0.026	71.2	0.185	-45.3	4.81
2400.0000	0.079	-161.1	3.738	175.3	0.028	69.1	0.192	-44.7	4.58
2500.0000	0.094	-165.5	3.579	171.2	0.030	63.8	0.202	-43.2	4.48
2600.0000	0.108	-169.0	3.411	166.5	0.030	64.7	0.214	-43.6	4.59
2700.0000	0.123	-174.7	3.283	161.4	0.032	64.6	0.222	-45.7	4.54
2800.0000	0.139	-178.9	3.107	157.3	0.031	58.9	0.238	-47.6	4.83
2900.0000	0.151	175.9	2.989	151.4	0.032	53.2	0.240	-52.4	4.84
3000.0000	0.164	170.5	2.814	147.3	0.033	51.6	0.251	-55.8	4.99
3100.0000	0.178	166.0	2.680	141.5	0.034	47.3	0.254	-61.4	5.07

PACAGE DIMENSIONS

6 pin super minimold (Unit: mm)

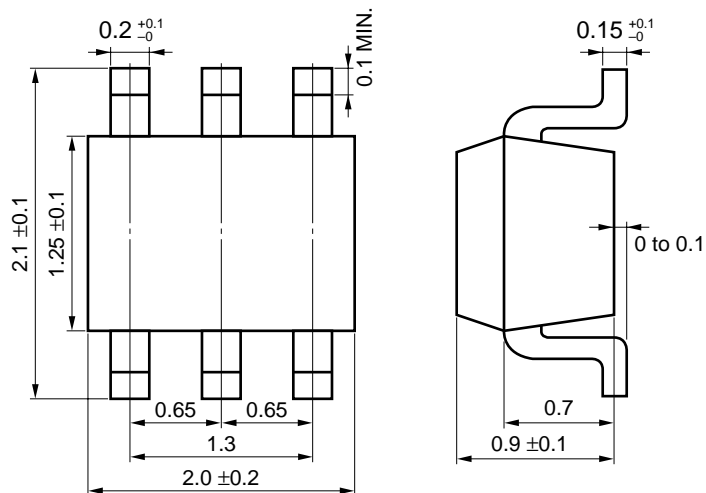

NOTES ON CORRECT USE

- (1) Observe precautions for handling because of electro-static sensitive devices.
- (2) Form a ground pattern as wide as possible to minimize ground impedance (to prevent undesired oscillation).
All the ground pins must be connected together with wide ground pattern to decrease impedance difference.
- (3) The bypass capacitor should be attached to Vcc line.
- (4) The DC cut capacitor must be attached to input pin.

RECOMMENDED SOLDERING CONDITIONS

This product should be soldered under the following recommended conditions. For soldering methods and conditions other than those recommended below, contact your NEC sales representative.

Soldering Method	Soldering Conditions	Recommended Condition Symbol
Infrared Reflow	Package peak temperature: 235 °C or below Time: 30 seconds or less (at 210 °C) Count: 3, Exposure limit: None ^{Note}	IR35-00-3
VPS	Package peak temperature: 215 °C or below Time: 40 seconds or less (at 200 °C) Count: 3, Exposure limit: None ^{Note}	VP15-00-3
Wave Soldering	Soldering bath temperature: 260 °C or below Time: 10 seconds or less Count: 1, Exposure limit: None ^{Note}	WS60-00-1
Partial Heating	Pin temperature: 300 °C Time: 3 seconds or less (per side of device) Exposure limit: None ^{Note}	—

Note After opening the dry pack, keep it in a place below 25 °C and 65 % RH for the allowable storage period.

Caution Do not use different soldering methods together (except for partial heating).

For details of recommended soldering conditions for surface mounting, refer to information document SEMICONDUCTOR DEVICE MOUNTING TECHNOLOGY MANUAL (C10535E).

[MEMO]

[MEMO]

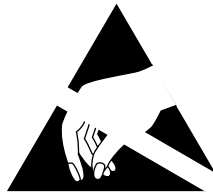

ATTENTION

OBSERVE PRECAUTIONS
FOR HANDLING
ELECTROSTATIC
SENSITIVE
DEVICES

NESAT (NEC Silicon Advanced Technology) is a trademark of NEC Corporation.

- **The information in this document is subject to change without notice. Before using this document, please confirm that this is the latest version.**
 - No part of this document may be copied or reproduced in any form or by any means without the prior written consent of NEC Corporation. NEC Corporation assumes no responsibility for any errors which may appear in this document.
 - NEC Corporation does not assume any liability for infringement of patents, copyrights or other intellectual property rights of third parties by or arising from use of a device described herein or any other liability arising from use of such device. No license, either express, implied or otherwise, is granted under any patents, copyrights or other intellectual property rights of NEC Corporation or others.
 - Descriptions of circuits, software, and other related information in this document are provided for illustrative purposes in semiconductor product operation and application examples. The incorporation of these circuits, software, and information in the design of the customer's equipment shall be done under the full responsibility of the customer. NEC Corporation assumes no responsibility for any losses incurred by the customer or third parties arising from the use of these circuits, software, and information.
 - While NEC Corporation has been making continuous effort to enhance the reliability of its semiconductor devices, the possibility of defects cannot be eliminated entirely. To minimize risks of damage or injury to persons or property arising from a defect in an NEC semiconductor device, customers must incorporate sufficient safety measures in its design, such as redundancy, fire-containment, and anti-failure features.
 - NEC devices are classified into the following three quality grades:
"Standard", "Special", and "Specific". The Specific quality grade applies only to devices developed based on a customer designated "quality assurance program" for a specific application. The recommended applications of a device depend on its quality grade, as indicated below. Customers must check the quality grade of each device before using it in a particular application.
 - Standard: Computers, office equipment, communications equipment, test and measurement equipment, audio and visual equipment, home electronic appliances, machine tools, personal electronic equipment and industrial robots
 - Special: Transportation equipment (automobiles, trains, ships, etc.), traffic control systems, anti-disaster systems, anti-crime systems, safety equipment and medical equipment (not specifically designed for life support)
 - Specific: Aircraft, aerospace equipment, submersible repeaters, nuclear reactor control systems, life support systems or medical equipment for life support, etc.
- The quality grade of NEC devices is "Standard" unless otherwise specified in NEC's Data Sheets or Data Books. If customers intend to use NEC devices for applications other than those specified for Standard quality grade, they should contact an NEC sales representative in advance.