

TOSHIBA BIPOLAR DIGITAL INTEGRATED CIRCUIT SILICON MONOLITHIC

TD62064P, TD62064AP, TD62064F, TD62064AF
TD62074P, TD62074AP, TD62074F, TD62074AF

4CH HIGH-CURRENT DARLINGTON SINK DRIVER

The TD62064P/AP/F/AF and TD62074P/AP/F/AF are high-voltage, high-current darlington drivers comprised of four NPN darlington pairs.

All units feature integral clamp diodes for switching inductive loads and all units of TD62074P/AP/F/AF feature uncommitted collectors and emitters for isolated darlington applications.

For proper operation, the substrate (SUB) must be connected to the most negative voltage.

Applications include relay, hammer, lamp and stepping moter drivers.

FEATURES

- Output current (single output) 1.5A (Max.)
- High sustaining voltage output
 35V (Min.) (TD62064P/F, 074P/F)
 50V (Min.) (TD62064AP/AF, 074AP/AF)
- Output clamp diodes : TD62064P/AP/F/AF
- Isolated darlington array : TD62074P/AP/F/AF
- Input compatible with TTL and 5V CMOS
- GND and SUB terminal = heat sink
- Package type-P, AP : DIP-16pin
- Package type-F, AF : HSOP-16pin

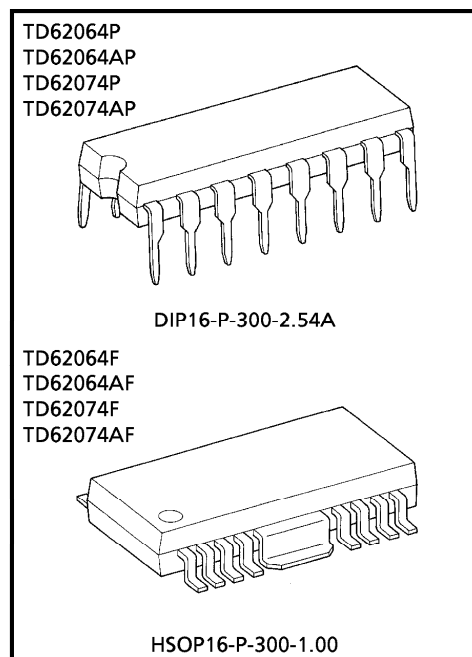

Weight
 DIP16-P-300-2.54A : 1.11g (Typ.)
 HSOP16-P-300-1.00 : 0.50g (Typ.)

PIN CONNECTION (TOP VIEW)

TD62064P/AP

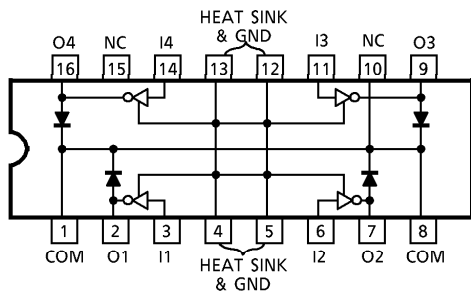

TD62074P/AP

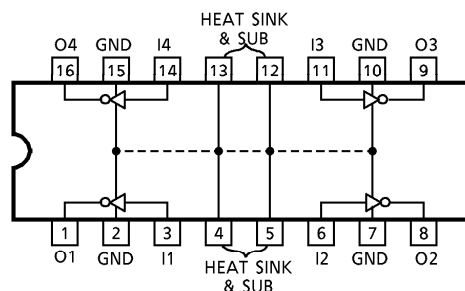

961001EBA2

● TOSHIBA is continually working to improve the quality and the reliability of its products. Nevertheless, semiconductor devices in general can malfunction or fail due to their inherent electrical sensitivity and vulnerability to physical stress. It is the responsibility of the buyer, when utilizing TOSHIBA products, to observe standards of safety, and to avoid situations in which a malfunction or failure of a TOSHIBA product could cause loss of human life, bodily injury or damage to property. In developing your designs, please ensure that TOSHIBA products are used within specified operating ranges as set forth in the most recent products specifications. Also, please keep in mind the precautions and conditions set forth in the TOSHIBA Semiconductor Reliability Handbook.

● The products described in this document are subject to foreign exchange and foreign trade control laws.

● The information contained herein is presented only as a guide for the applications of our products. No responsibility is assumed by TOSHIBA CORPORATION for any infringements of intellectual property or other rights of the third parties which may result from its use. No license is granted by implication or otherwise under any intellectual property or other rights of TOSHIBA CORPORATION or others.

● The information contained herein is subject to change without notice.

TD62064F / AF

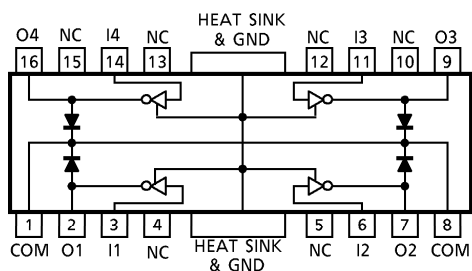

TD62074F / AF

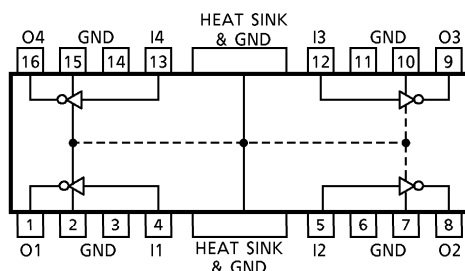

SCHEMATICS (EACH DRIVER)

TD62064P / AP / F / AF

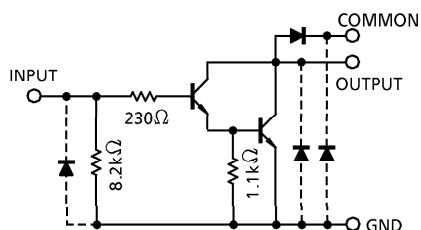

TD62074P / AP / F / AF

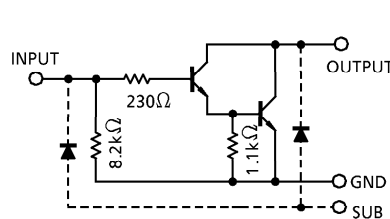

(Note) The input and output parasitic diodes cannot be used as clamp diodes.

MAXIMUM RATINGS (Ta = 25°C)

CHARACTERISTIC	SYMBOL	RATING	UNIT
Output Sustaining Voltage	P, F	- 0.5~35	V
	AP, AF	- 0.5~50	
Output Current	I _{OUT}	1.5	A / ch
Input Current	I _{IN}	50	mA
Input Voltage	V _{IN}	- 0.5~17	V
Clamp Diode Reverse Voltage	P, F	35	V
	AP, AF	50	
Clamp Diode Forward Current	I _F (Note 1)	1.5	A / ch
Isolated Voltage	P, F	35	V
	AP, AF	50	
Power Dissipation	P, AP	1.47 / 2.7 (Note 3)	W
	F, AF	0.9 / 1.4 (Note 4)	
Operating Temperature	T _{opr}	- 40~85	°C
Storage Temperature	T _{stg}	- 55~150	°C

- (Note 1) TD62064P / AP / F / AF
- (Note 2) TD62074P / AP / F / AF
- (Note 3) On Glass Epoxy (50 × 50 × 1.6mm Cu 50%)
- (Note 4) On Glass Epoxy (60 × 30 × 1.6mm Cu 30%)

RECOMMENDED OPERATING CONDITIONS (Ta = -40~85°C)

CHARACTERISTIC		SYMBOL	TEST CONDITION	MIN.	TYP.	MAX.	UNIT
Output Sustaining Voltage	P, F	V _{CE (SUS)}		0	—	35	V
	AP, AF			0	—	50	
Output Current	P, AP (Note 1)	I _{OUT}	DC1 Circuit, Ta = 25°C	0	—	1250	mA / ch
			T _{pw} = 25ms 4 Circuits	Duty = 10%	0	—	
	Duty = 50%			0	—	390	
	F, AF (Note 2)		T _j = 120°C	Duty = 10%	0	—	
Ta = 85°C		Duty = 50%	0	—	172		
Input Voltage		V _{IN}		0	—	8	V
	(Output On)	V _{IN (ON)}	I _{OUT} = 1.25A	2.5	—	8	V
	(Output Off)	V _{IN (OFF)}		0	—	0.4	V
Input Current		I _{IN}		0	—	20	mA
Clamp Diode Reverse Voltage	P, F	V _R	TD62064P / AP / F / AF	0	—	35	V
	AP, AF			0	—	50	
Clamp Diode Forward Current		I _F		—	—	1.25	A
Isolation Voltage	P, F	V _{SUB}	TD62074P / AP / F / AF	—	—	35	V
	AP, AF			—	—	50	
Power Dissipation	P, AP	P _D	Ta = 85°C (Note 1)	—	—	1.4	W
	F, AF		Ta = 85°C (Note 2)	—	—	0.7	

(Note 1) On Glass Epoxy (50×50×1.6mm Cu 50%)

(Note 2) On Glass Epoxy (60×30×1.6mm Cu 30%)

ELECTRICAL CHARACTERISTICS (Ta = 25°C)

CHARACTERISTIC	SYMBOL	TEST CIRCUIT	TEST CONDITION	MIN.	TYP.	MAX.	UNIT	
Output Leakage Current	AP, AF	1	$V_{CE} = 50V, T_a = 25^\circ C$	—	—	50	μA	
			$V_{CE} = 50V, T_a = 85^\circ C$	—	—	500		
	P, F		$V_{CE} = 35V, T_a = 25^\circ C$	—	—	50		
			$V_{CE} = 35V, T_a = 85^\circ C$	—	—	500		
Collector-Emitter Saturation Voltage	$V_{CE(sat)}$	2	$I_{OUT} = 1.25A, I_{IN} = 2mA$	—	—	1.6	V	
			$I_{OUT} = 0.75A, I_{IN} = 935\mu A$	—	—	1.25		
DC Current Transfer Ratio	h_{FE}	2	$V_{CE} = 2V$	$I_{OUT} = 1.0A$	—	800	—	
				$I_{OUT} = 0.25A$	—	1500		
Input Voltage (Output On)	$V_{IN(ON)}$	3	$I_{OUT} = 1.25A, I_{IN} = 2mA$	—	—	2.4	V	
Clamp Diode Leakage Current	AP, AF	4	$V_R = 50V, T_a = 25^\circ C$	—	—	50	μA	
			$V_R = 50V, T_a = 85^\circ C$	—	—	100		
	F		$V_R = 35V, T_a = 25^\circ C$	—	—	50		
			$V_R = 35V, T_a = 85^\circ C$	—	—	100		
Clamp Diode Forward Voltage	V_F	5	$I_F = 1.25A$	—	—	2	V	
Input Capacitance	C_{IN}	6	$V_{IN} = 0V, f = 1MHz$	—	15	—	pF	
Turn-On Delay	P, F	t_{ON}	$C_L = 15pF$	$V_{OUT} = 35V, R_L = 29\Omega$	—	0.1	μs	
	AP, AF			$V_{OUT} = 50V, R_L = 42\Omega$				
Turn-Off Delay	P, F	t_{OFF}		$V_{OUT} = 35V, R_L = 29\Omega$	—	1.0		—
	AP, AF			$V_{OUT} = 50V, R_L = 42\Omega$				

TEST CIRCUIT

1. I_{CEX}

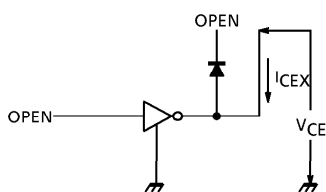

2. $V_{CE(sat)}, h_{FE}$

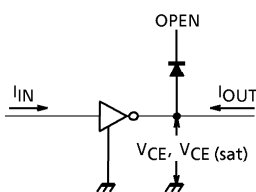

3. $V_{IN(ON)}$

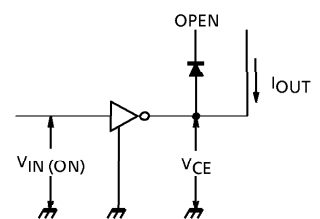

4. I_R

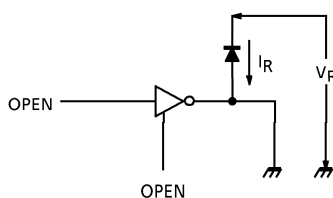

5. V_F

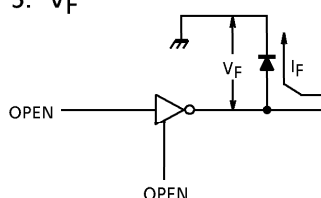

6. C_{IN}

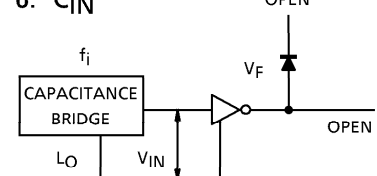

7. t_{ON} , t_{OFF}

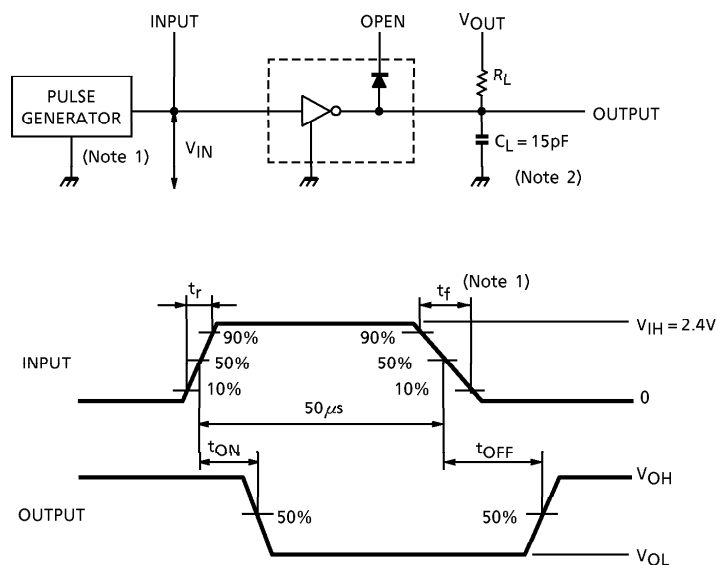

- (Note 1) Pulse Width $50\mu\text{s}$, Duty Cycle 10%
Output Impedance 50Ω , $t_r \leq 5\text{ns}$, $t_f \leq 10\text{ns}$
- (Note 2) C_L includes probe and jig capacitance

PRECAUTIONS for USING

Utmost care is necessary in the design of the output line, COMMON and GND line since IC may be destroyed due to short-circuit between outputs, air contamination fault, or fault by improper grounding.

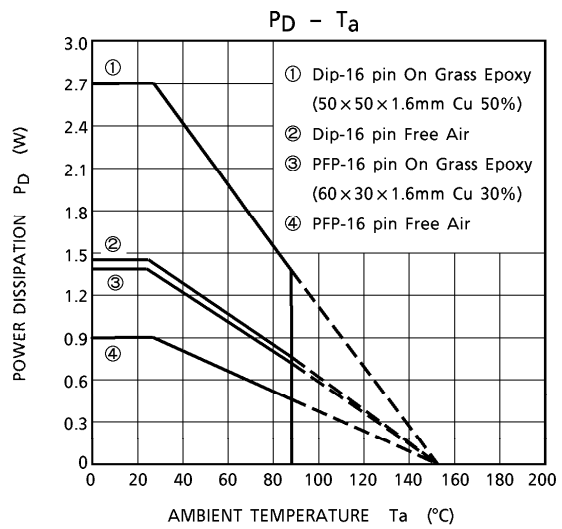
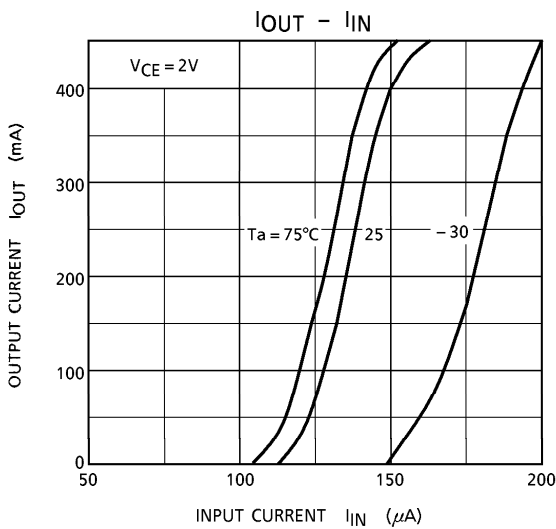
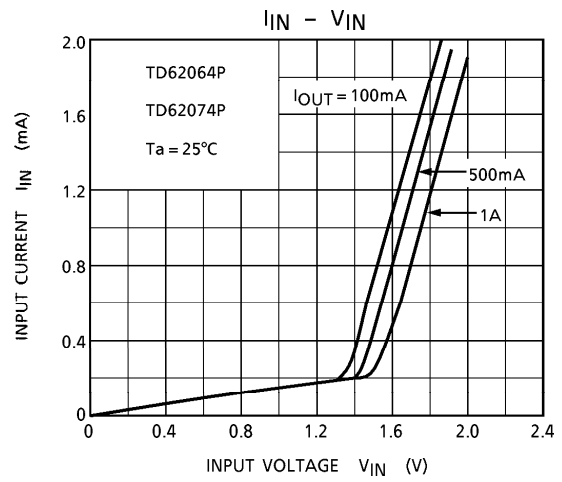
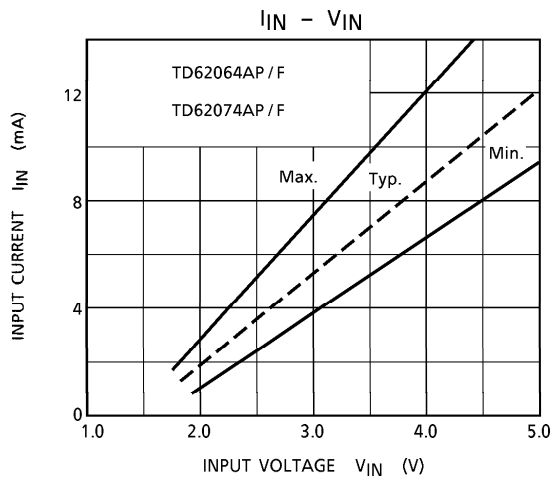
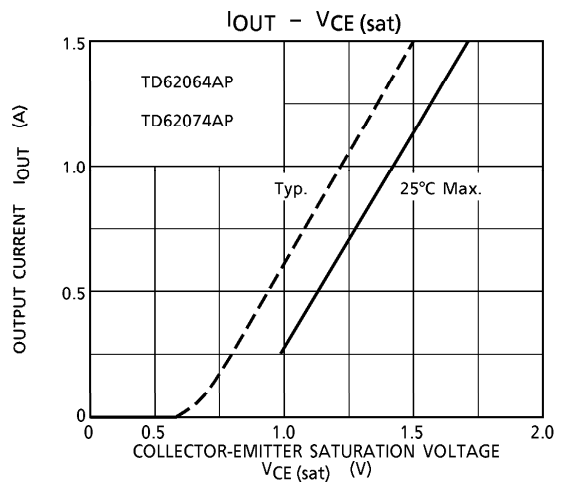
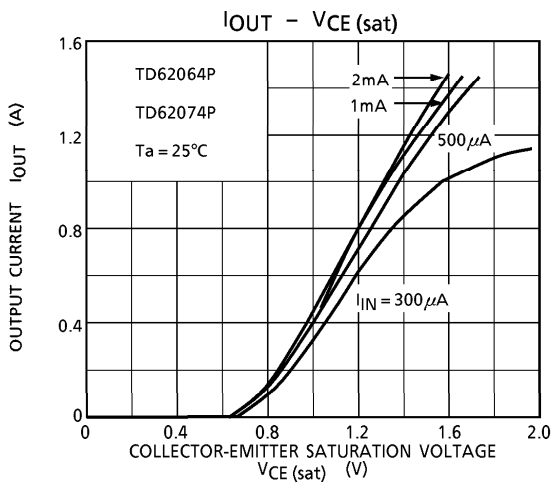

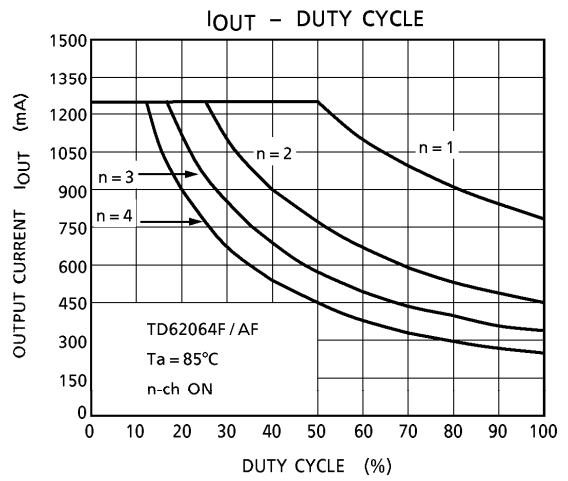
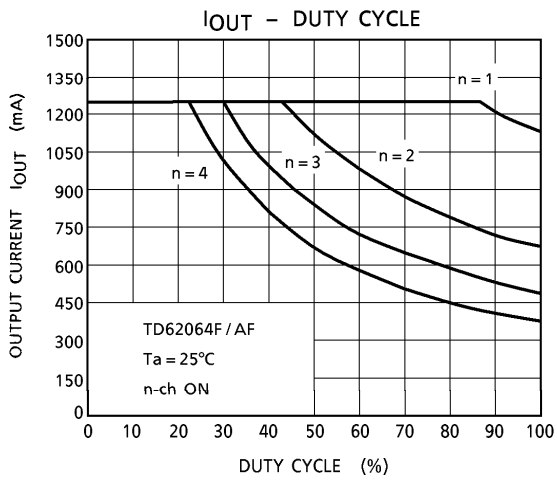
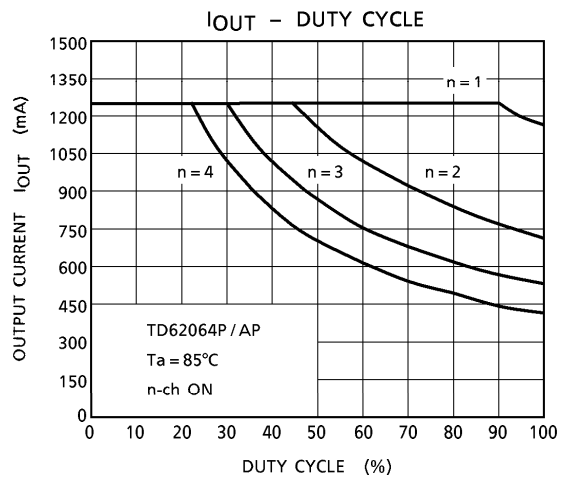
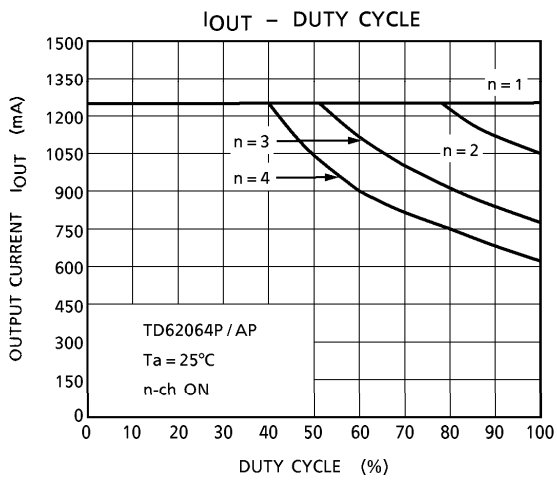

OUTLINE DRAWING
DIP16-P-300-2.54A

Unit : mm

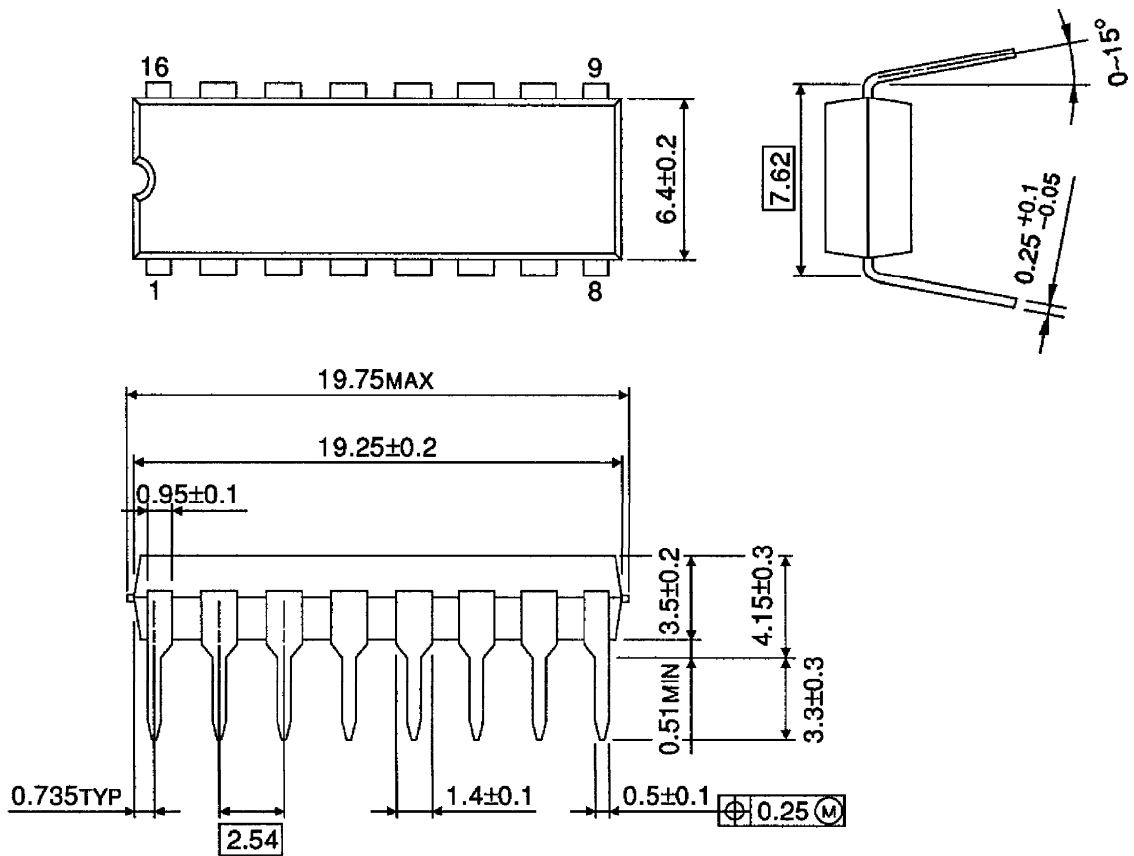

Weight : 1.11g (Typ.)

OUTLINE DRAWING
HSOP16-P-300-1.00

Unit : mm

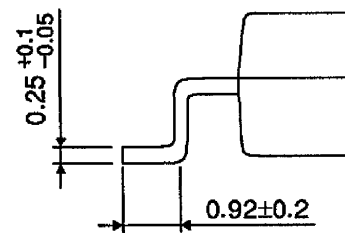
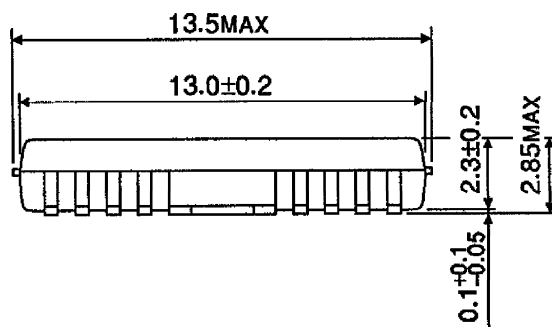
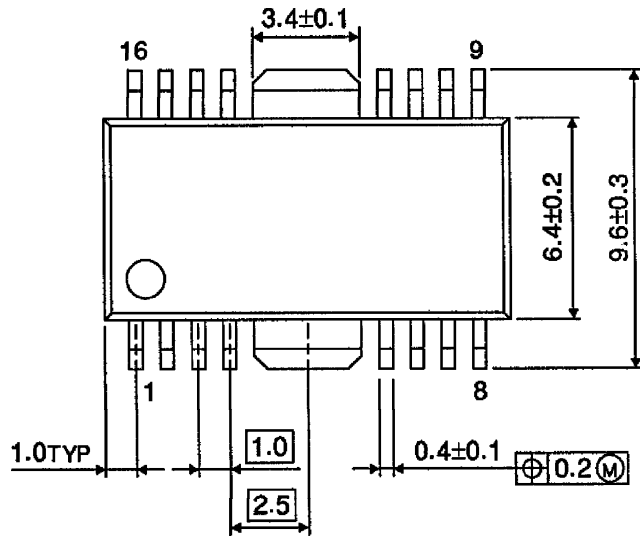

Weight : 0.50g (Typ.)