

International IR Rectifier

IRFP460P

- Dynamic dv/dt Rating
- Repetitive Avalanche Rated
- Isolated Central Mounting Hole
- Fast Switching
- Ease of Paralleling
- Simple Drive Requirements
- Solder Plated for Reflowing

HEXFET® Power MOSFET

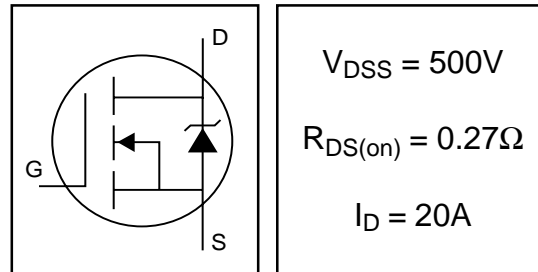

Description

Third Generation HEXFET®s from International Rectifier provide the designer with the best combination of fast switching, ruggedized device design, low on-resistance and cost-effectiveness.

The TO-247 package is preferred for commercial-industrial applications where higher power levels preclude the use of TO-220 devices. The TO-247 is similar but superior to the earlier TO-218 package because of its isolated mounting hole. It also provides greater creepage distance between pins to meet the requirements of most safety specifications.

The solder plated version of the TO-247 allows the reflow soldering of the package heatsink to a substrate material.



Absolute Maximum Ratings

	Parameter	Max.	Units
$I_D @ T_C = 25^\circ C$	Continuous Drain Current, $V_{GS} @ 10V$	20	A
$I_D @ T_C = 100^\circ C$	Continuous Drain Current, $V_{GS} @ 10V$	13	
I_{DM}	Pulsed Drain Current ①	80	
$P_D @ T_C = 25^\circ C$	Power Dissipation	280	W
	Linear Derating Factor	2.2	W/°C
V_{GS}	Gate-to-Source Voltage	± 20	V
E_{AS}	Single Pulse Avalanche Energy ②	960	mJ
I_{AR}	Avalanche Current ①	20	A
E_{AR}	Repetitive Avalanche Energy ①	28	mJ
dv/dt	Peak Diode Recovery dv/dt ③	3.5	V/ns
T_J	Operating Junction and	-55 to + 150	°C
T_{STG}	Storage Temperature Range		
	Soldering Temperature, for 10 seconds	300 (1.6mm from case)	
	Mounting torque, 6-32 or M3 srew	10 lbf•in (1.1N•m)	
	Maximum Reflow Temperature	230 (Time above 183 °C should not exceed 100s)	°C

Thermal Resistance

	Parameter	Typ.	Max.	Units
$R_{\theta JC}$	Junction-to-Case	—	0.45	°C/W
$R_{\theta CS}$	Case-to-Sink, Flat, Greased Surface	0.24	—	
$R_{\theta JA}$	Junction-to-Ambient	—	40	

Electrical Characteristics @ T_J = 25°C (unless otherwise specified)

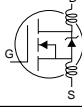
	Parameter	Min.	Typ.	Max.	Units	Conditions
V _{(BR)DSS}	Drain-to-Source Breakdown Voltage	500	—	—	V	V _{GS} = 0V, I _D = 250μA
ΔV _{(BR)DSS} /ΔT _J	Breakdown Voltage Temp. Coefficient	—	0.63	—	V/°C	Reference to 25°C, I _D = 1mA
R _{DS(on)}	Static Drain-to-Source On-Resistance	—	—	0.27	Ω	V _{GS} = 10V, I _D = 12A ④
V _{GS(th)}	Gate Threshold Voltage	2.0	—	4.0	V	V _{DS} = V _{GS} , I _D = 250μA
g _{fs}	Forward Transconductance	13	—	—	S	V _{DS} = 50V, I _D = 12A
I _{DSS}	Drain-to-Source Leakage Current	—	—	25	μA	V _{DS} = 500V, V _{GS} = 0V
		—	—	250		V _{DS} = 400V, V _{GS} = 0V, T _J = 125°C
I _{GSS}	Gate-to-Source Forward Leakage	—	—	100	nA	V _{GS} = 20V
	Gate-to-Source Reverse Leakage	—	—	-100		V _{GS} = -20V
Q _g	Total Gate Charge	—	—	210	nC	I _D = 20A
Q _{gs}	Gate-to-Source Charge	—	—	29		V _{DS} = 400V
Q _{gd}	Gate-to-Drain ("Miller") Charge	—	—	110		V _{GS} = 10V, See Fig. 6 and 13 ④
t _{d(on)}	Turn-On Delay Time	—	18	—	ns	V _{DD} = 250V
t _r	Rise Time	—	59	—		I _D = 20A
t _{d(off)}	Turn-Off Delay Time	—	110	—		R _G = 4.3Ω
t _f	Fall Time	—	58	—		R _D = 13Ω, See Fig. 10 ④
L _D	Internal Drain Inductance	—	5.0	—	nH	Between lead, 6mm (0.25in.) from package and center of die contact
L _S	Internal Source Inductance	—	13	—		
C _{iss}	Input Capacitance	—	4200	—	pF	V _{GS} = 0V
C _{oss}	Output Capacitance	—	870	—		V _{DS} = 25V
C _{rss}	Reverse Transfer Capacitance	—	350	—		f = 1.0MHz, See Fig. 5

Source-Drain Ratings and Characteristics

	Parameter	Min.	Typ.	Max.	Units	Conditions
I _S	Continuous Source Current (Body Diode)	—	—	20	A	MOSFET symbol showing the integral reverse p-n junction diode.
I _{SM}	Pulsed Source Current (Body Diode) ①	—	—	80		
V _{SD}	Diode Forward Voltage	—	—	1.8	V	T _J = 25°C, I _S = 20A, V _{GS} = 0V ④
t _{rr}	Reverse Recovery Time	—	570	860	ns	T _J = 25°C, I _F = 20A
Q _{rr}	Reverse RecoverCharge	—	5.7	8.6	μC	di/dt = 100A/μs ④
t _{on}	Forward Turn-On Time	Intrinsic turn-on time is negligible (turn-on is dominated by L _S +L _D)				

Notes:

① Repetitive rating; pulse width limited by max. junction temperature. (See fig. 11)

② Starting T_J = 25°C, L = 4.8mH
R_G = 25Ω, I_{AS} = 20A. (See Figure 12)

③ I_{SD} ≤ 20A, di/dt ≤ 160A/μs, V_{DD} ≤ V_{(BR)DSS},
T_J ≤ 150°C

④ Pulse width ≤ 300μs; duty cycle ≤ 2%.

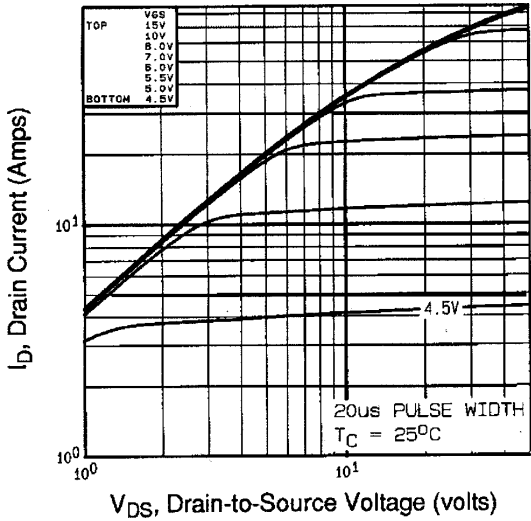

Fig 1. Typical Output Characteristics

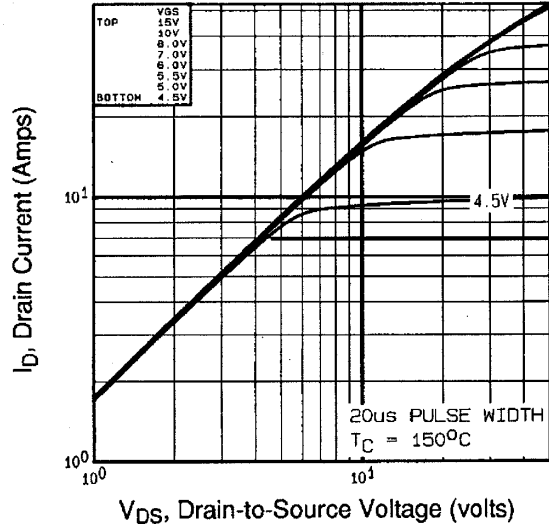

Fig 2. Typical Output Characteristics

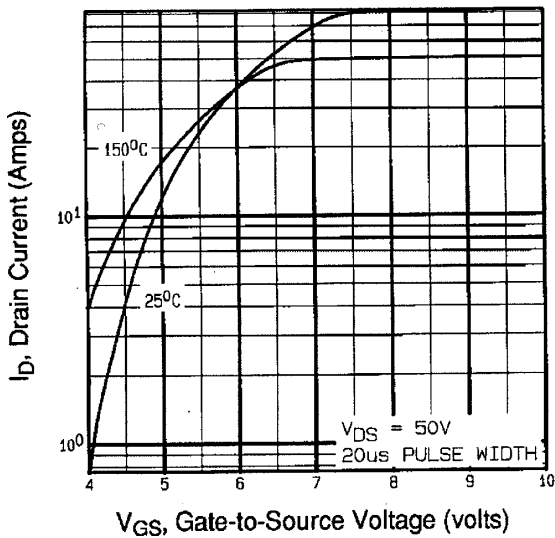

Fig 3. Typical Transfer Characteristics

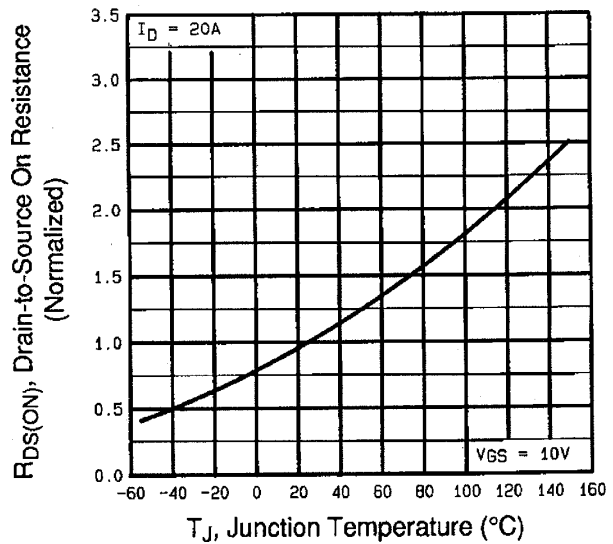

Fig 4. Normalized On-Resistance Vs. Temperature

IRFP460P

International
IR Rectifier

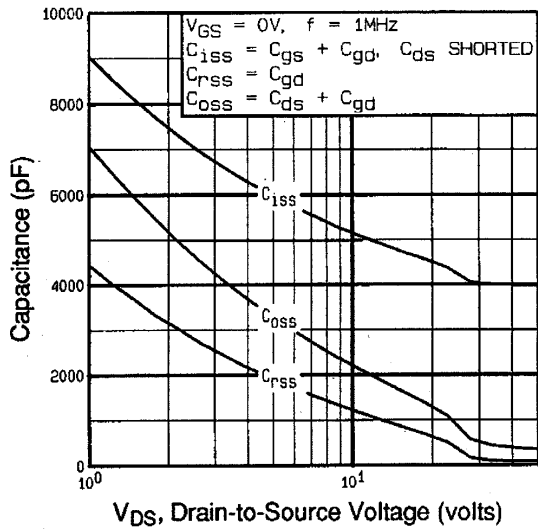

Fig 5. Typical Capacitance Vs. Drain-to-Source Voltage

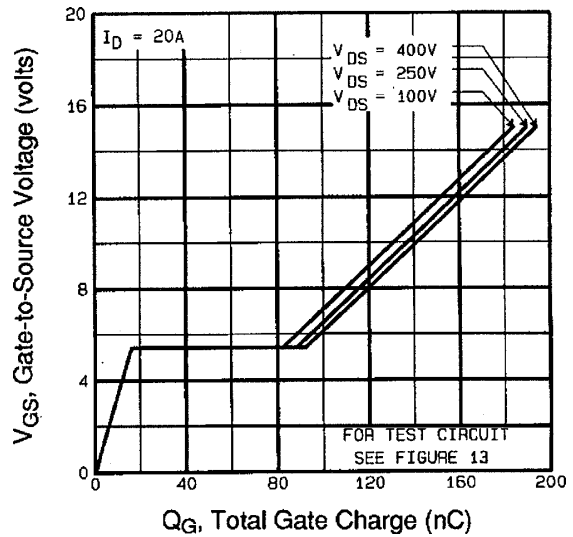

Fig 6. Typical Gate Charge Vs. Gate-to-Source Voltage

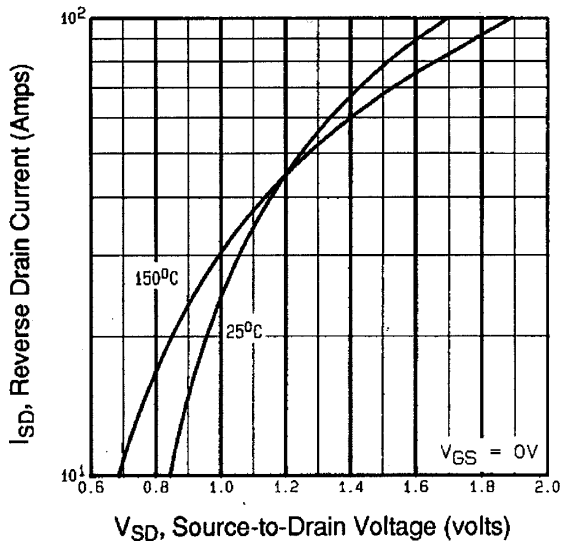

Fig 7. Typical Source-Drain Diode Forward Voltage

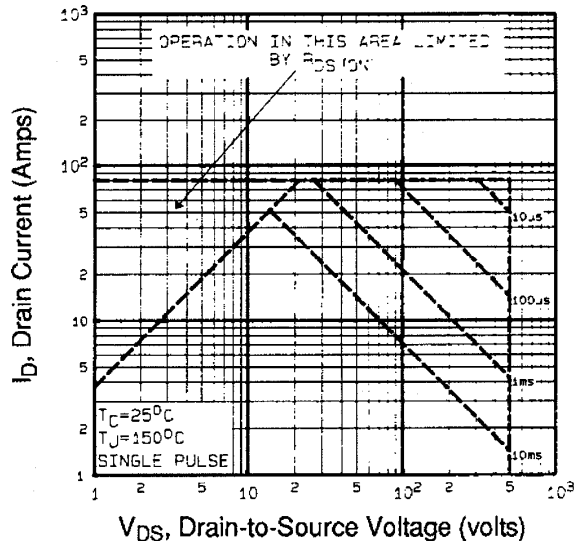

Fig 8. Maximum Safe Operating Area

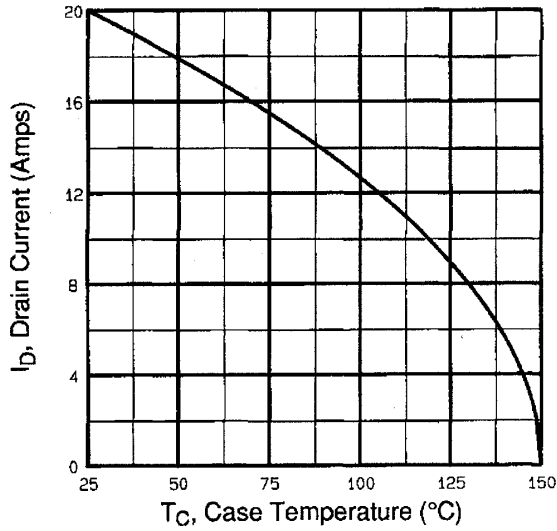

Fig 9. Maximum Drain Current Vs. Case Temperature

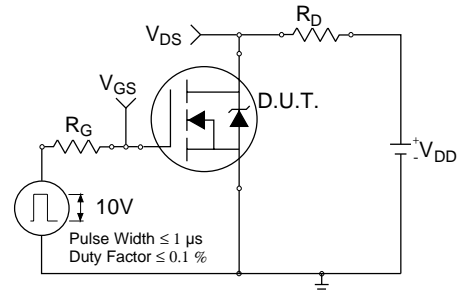

Fig 10a. Switching Time Test Circuit

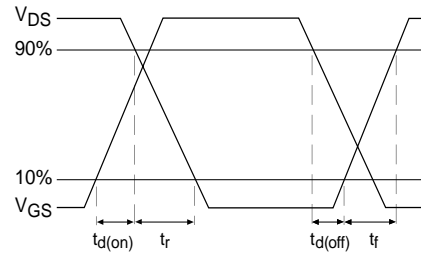

Fig 10b. Switching Time Waveforms

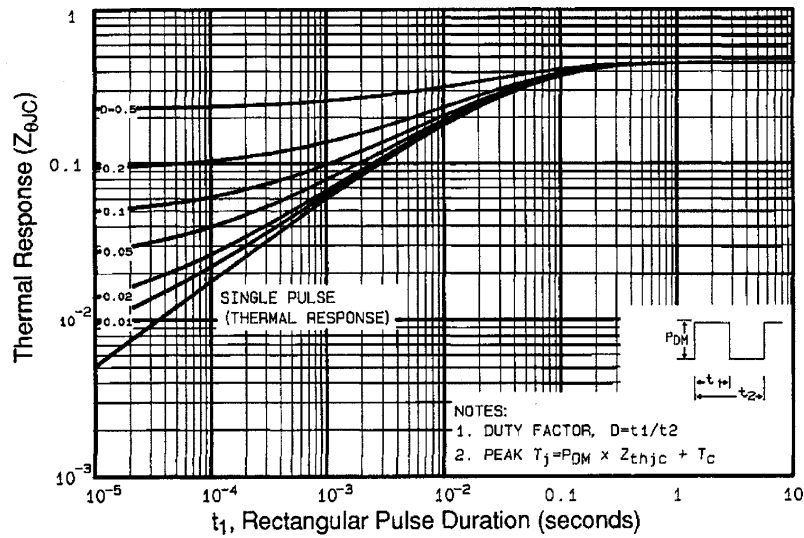

Fig 11. Maximum Effective Transient Thermal Impedance, Junction-to-Case

IRFP460P

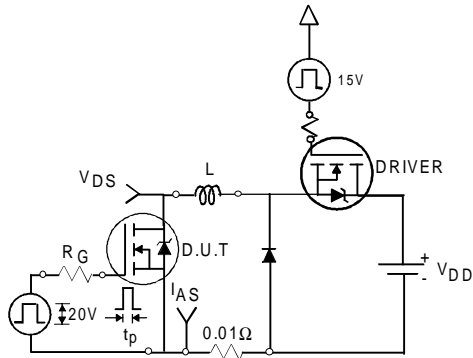

Fig 12a. Unclamped Inductive Test Circuit

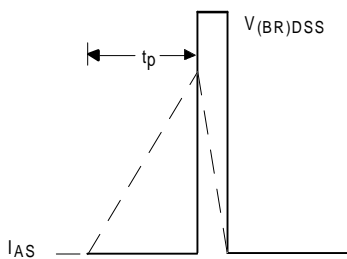

Fig 12b. Unclamped Inductive Waveforms

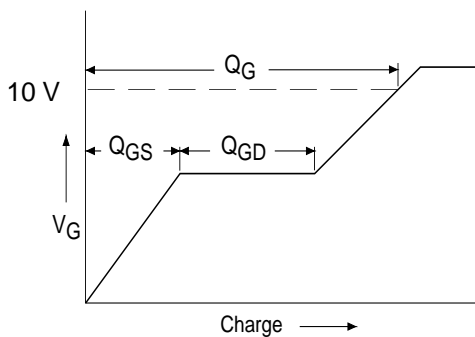

Fig 13a. Basic Gate Charge Waveform

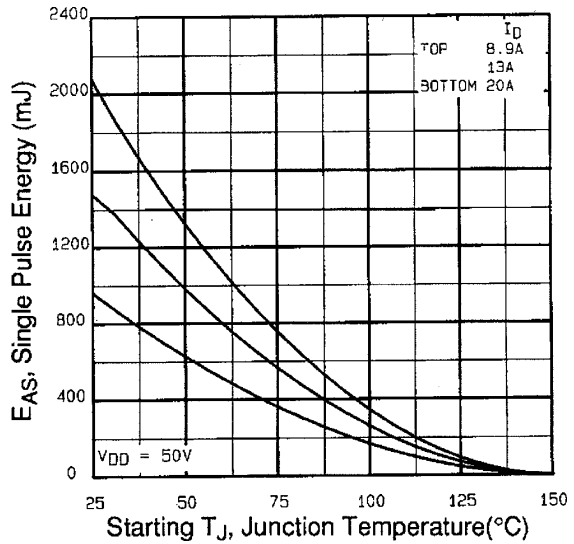

Fig 12c. Maximum Avalanche Energy Vs. Drain Current

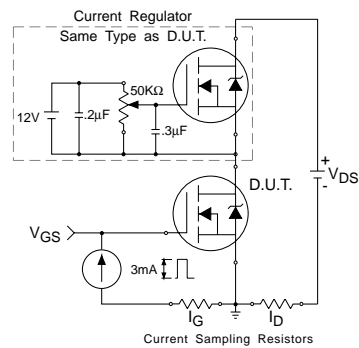
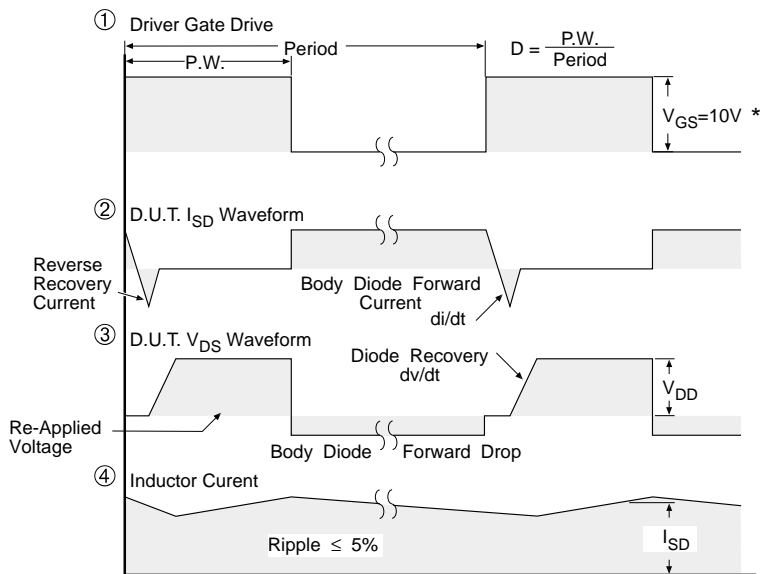
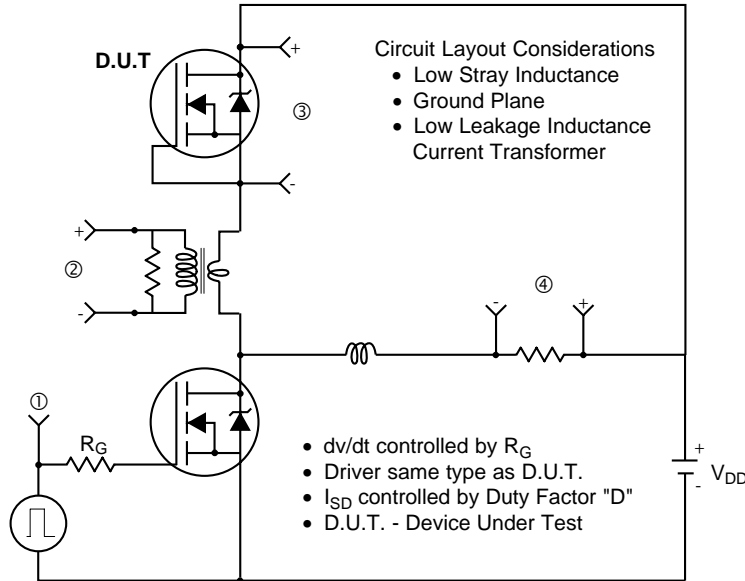

Fig 13b. Gate Charge Test Circuit

Peak Diode Recovery dv/dt Test Circuit



* $V_{GS} = 5V$ for Logic Level Devices

Fig 14. For N-Channel HEXFET®s

IRFP460P

International
IR Rectifier

Package Outline

TO-247AC

Dimensions are shown in millimeters (inches)

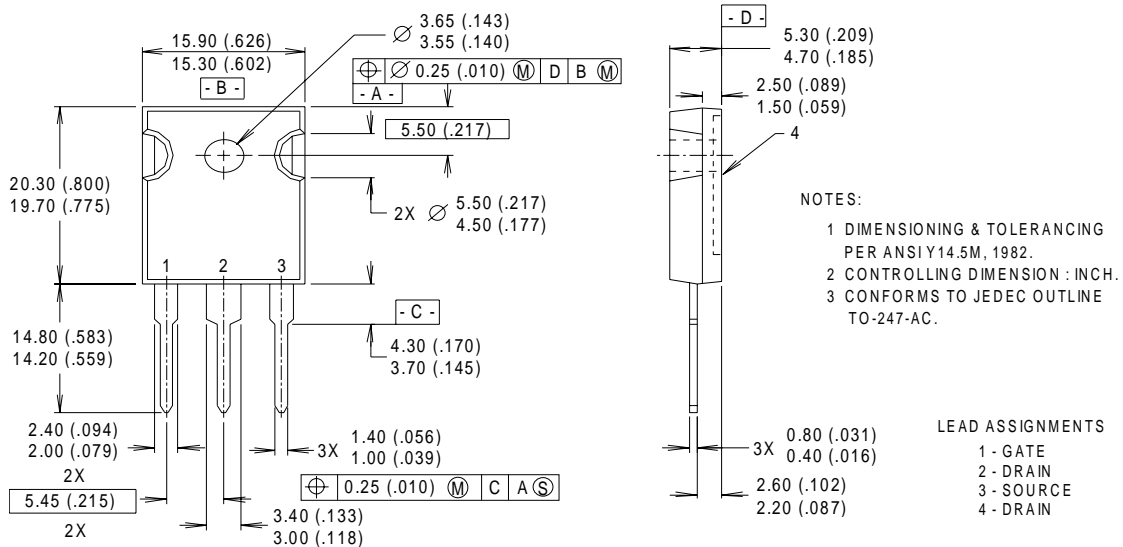

Part Marking Information

TO-247AC

EXAMPLE : THIS IS AN IRFPE30
WITH ASSEMBLY
LOT CODE 3A1Q

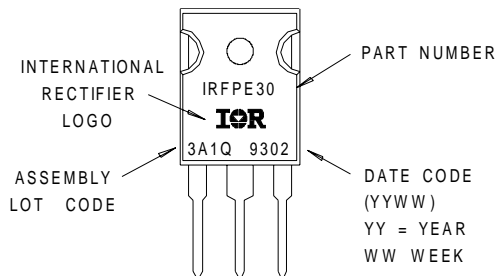

Data and specifications subject to change without notice.
This product has been designed and qualified for the industrial market.
Qualification Standards can be found on IR's Web site.

International
IR Rectifier

IR WORLD HEADQUARTERS: 233 Kansas St., El Segundo, California 90245, USA Tel: (310) 252-7105
TAC Fax: (310) 252-7903

Visit us at www.irf.com for sales contact information.12/00