



# STB5NB60

## N - CHANNEL 600V - 1.8Ω - 5A - I<sup>2</sup>PAK/D<sup>2</sup>PAK PowerMESH™ MOSFET

TYPE	V <sub>DSS</sub>	R <sub>DS(on)</sub>	I <sub>D</sub>
STB5NB60	600 V	< 2.0 Ω	5 A

- TYPICAL R<sub>DS(on)</sub> = 1.8 Ω
- EXTREMELY HIGH dv/dt CAPABILITY
- 100% AVALANCHE TESTED
- VERY LOW INTRINSIC CAPACITANCES
- GATE CHARGE MINIMIZED

### DESCRIPTION

Using the latest high voltage MESH OVERLAY™ process, STMicroelectronics has designed an advanced family of power MOSFETs with outstanding performances. The new patent pending strip layout coupled with the Company's proprietary edge termination structure, gives the lowest R<sub>DS(on)</sub> per area, exceptional avalanche and dv/dt capabilities and unrivalled gate charge and switching characteristics.

### APPLICATIONS

- HIGH CURRENT, HIGH SPEED SWITCHING
- SWITCH MODE POWER SUPPLIES (SMPS)
- DC-AC CONVERTERS FOR WELDING EQUIPMENT AND UNINTERRUPTIBLE POWER SUPPLIES AND MOTOR DRIVE

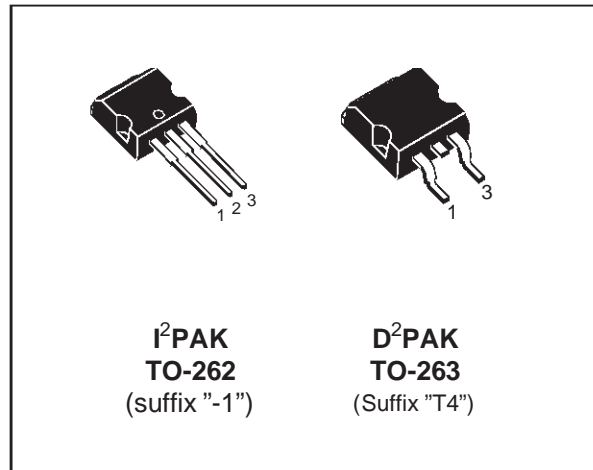

### ABSOLUTE MAXIMUM RATINGS

Symbol	Parameter	Value	Unit
V <sub>DS</sub>	Drain-source Voltage (V <sub>GS</sub> = 0)	600	V
V <sub>DGR</sub>	Drain- gate Voltage (R <sub>GS</sub> = 20 kΩ)	600	V
V <sub>GS</sub>	Gate-source Voltage	± 30	V
I <sub>D</sub>	Drain Current (continuous) at T <sub>c</sub> = 25 °C	5	A
I <sub>D</sub>	Drain Current (continuous) at T <sub>c</sub> = 100 °C	3.1	A
I <sub>DM</sub> (•)	Drain Current (pulsed)	20	A
P <sub>tot</sub>	Total Dissipation at T <sub>c</sub> = 25 °C	100	W
	Derating Factor	0.8	W/°C
dv/dt(1)	Peak Diode Recovery voltage slope	4.5	V/ns
T <sub>stg</sub>	Storage Temperature	-65 to 150	°C
T <sub>j</sub>	Max. Operating Junction Temperature	150	°C

(•) Pulse width limited by safe operating area

(1) I<sub>SD</sub> ≤ 5A, di/dt ≤ 200 A/μs, V<sub>DD</sub> ≤ V<sub>(BR)DSS</sub>, T<sub>j</sub> ≤ T<sub>JMAX</sub>

## STB5NB60

### THERMAL DATA

$R_{thj-case}$	Thermal Resistance Junction-case	Max	1.25	$^{\circ}C/W$
$R_{thj-amb}$	Thermal Resistance Junction-ambient	Max	62.5	$^{\circ}C/W$
$R_{thc-sink}$	Thermal Resistance Case-sink	Typ	0.5	$^{\circ}C/W$
$T_I$	Maximum Lead Temperature For Soldering Purpose		300	$^{\circ}C$

### AVALANCHE CHARACTERISTICS

Symbol	Parameter	Max Value	Unit
$I_{AR}$	Avalanche Current, Repetitive or Not-Repetitive (pulse width limited by $T_j$ max)	5	A
$E_{AS}$	Single Pulse Avalanche Energy (starting $T_j = 25^{\circ}C$ , $I_D = I_{AR}$ , $V_{DD} = 50$ V)	300	mJ

### ELECTRICAL CHARACTERISTICS ( $T_{case} = 25^{\circ}C$ unless otherwise specified)

OFF

Symbol	Parameter	Test Conditions	Min.	Typ.	Max.	Unit
$V_{(BR)DSS}$	Drain-source Breakdown Voltage	$I_D = 250 \mu A$ $V_{GS} = 0$ at $T_c = 100^{\circ}C$	600			V
$I_{DSS}$	Zero Gate Voltage Drain Current ( $V_{GS} = 0$ )	$V_{DS} = 600$ V $V_{DS} = \text{Max Rating}$ $T_c = 125^{\circ}C$			1 50	$\mu A$ $\mu A$
$I_{GSS}$	Gate-body Leakage Current ( $V_{DS} = 0$ )	$V_{GS} = \pm 30$ V			$\pm 100$	nA

ON (\*)

Symbol	Parameter	Test Conditions	Min.	Typ.	Max.	Unit
$V_{GS(th)}$	Gate Threshold Voltage	$V_{DS} = V_{GS}$ $I_D = 250 \mu A$	3	4	5	V
$R_{DS(on)}$	Static Drain-source On Resistance	$V_{GS} = 10$ V $I_D = 2.5$ A		1.8	2	$\Omega$
$I_{D(on)}$	On State Drain Current	$V_{DS} > I_{D(on)} \times R_{DS(on)max}$ $V_{GS} = 10$ V	5			A

### DYNAMIC

Symbol	Parameter	Test Conditions	Min.	Typ.	Max.	Unit
$g_{fs}$ (*)	Forward Transconductance	$V_{DS} > I_{D(on)} \times R_{DS(on)max}$ $I_D = 2.5$ A	2.5	4.5		S
$C_{iss}$	Input Capacitance	$V_{DS} = 25$ V $f = 1$ MHz $V_{GS} = 0$		680		pF
$C_{oss}$	Output Capacitance			103		pF
$C_{rss}$	Reverse Transfer Capacitance			10.5		pF

**ELECTRICAL CHARACTERISTICS** (continued)

**SWITCHING ON**

Symbol	Parameter	Test Conditions	Min.	Typ.	Max.	Unit
$t_{d(on)}$	Turn-on Time	$V_{DD} = 300\text{ V}$ $I_D = 2.5\text{ A}$ $R_G = 4.7\ \Omega$ $V_{GS} = 10\text{ V}$ (see test circuit, figure 3)		12		ns
$t_r$	Rise Time			10		ns
$Q_g$	Total Gate Charge	$V_{DD} = 480\text{ V}$ $I_D = 5\text{ A}$ $V_{GS} = 10\text{ V}$		21	30	nC
$Q_{gs}$	Gate-Source Charge			7.6		nC
$Q_{gd}$	Gate-Drain Charge			7.5		nC

**SWITCHING OFF**

Symbol	Parameter	Test Conditions	Min.	Typ.	Max.	Unit
$t_{r(Voff)}$	Off-voltage Rise Time	$V_{DD} = 480\text{ V}$ $I_D = 5\text{ A}$ $R_G = 4.7\ \Omega$ $V_{GS} = 10\text{ V}$ (see test circuit, figure 5)		8		ns
$t_f$	Fall Time			5		ns
$t_c$	Cross-over Time			14		ns

**SOURCE DRAIN DIODE**

Symbol	Parameter	Test Conditions	Min.	Typ.	Max.	Unit
$I_{SD}$	Source-drain Current				5	A
$I_{SDM}(\bullet)$	Source-drain Current (pulsed)				20	A
$V_{SD}(\ast)$	Forward On Voltage	$I_{SD} = 5\text{ A}$ $V_{GS} = 0$			1.6	V
$t_{rr}$	Reverse Recovery Time	$I_{SD} = 5\text{ A}$ $di/dt = 100\text{ A}/\mu\text{s}$ $V_{DD} = 100\text{ V}$ $T_j = 150\text{ }^\circ\text{C}$ (see test circuit, figure 5)		610		ns
$Q_{rr}$	Reverse Recovery Charge			3.6		$\mu\text{C}$
$I_{RRM}$	Reverse Recovery Current			11.7		A

(\*) Pulsed: Pulse duration = 300  $\mu\text{s}$ , duty cycle 1.5 %

(•) Pulse width limited by safe operating area

**Safe Operating Area**

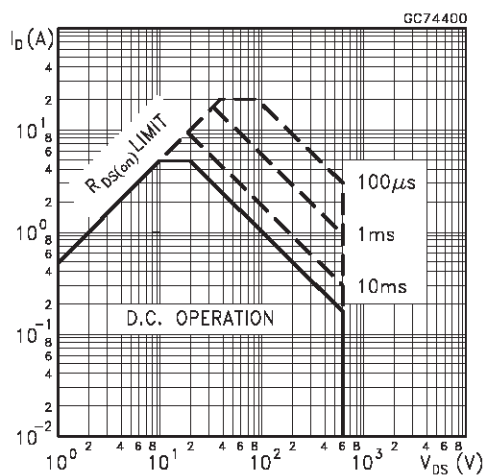

**Thermal Impedance**

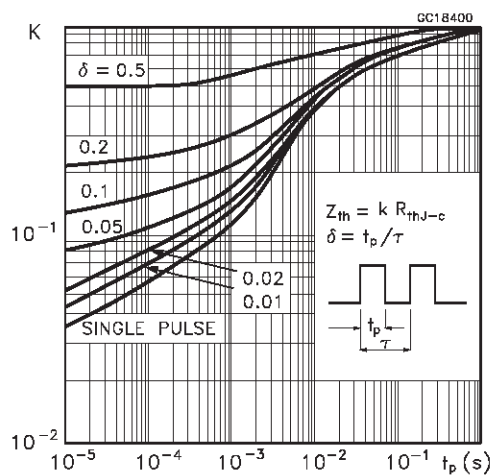

Output Characteristics

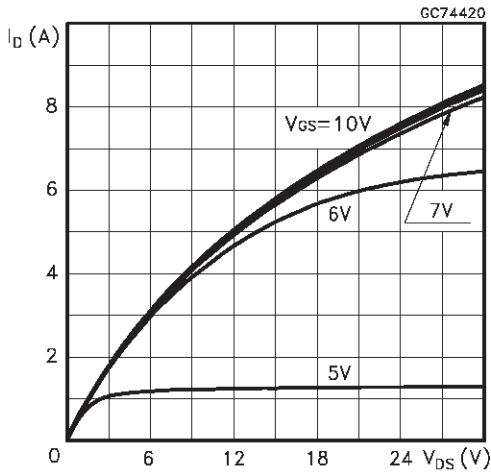

Transfer Characteristics

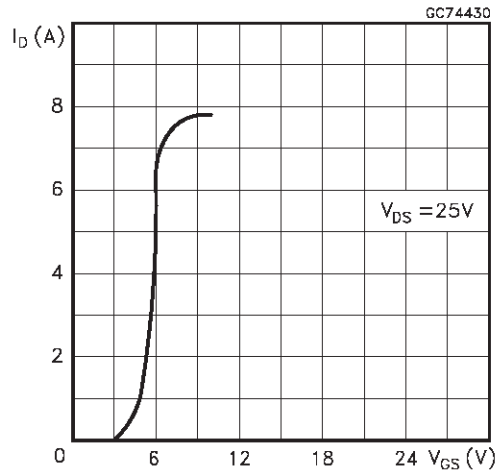

Transconductance

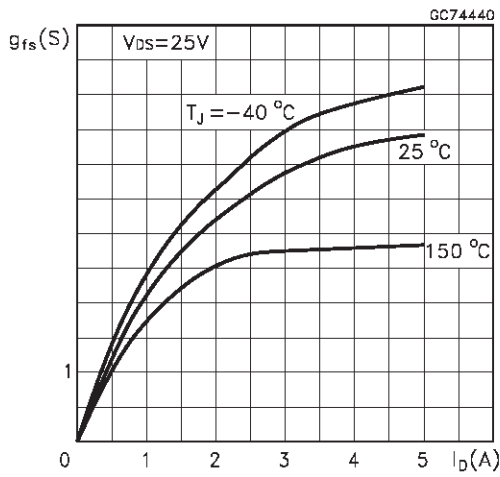

Static Drain-source On Resistance

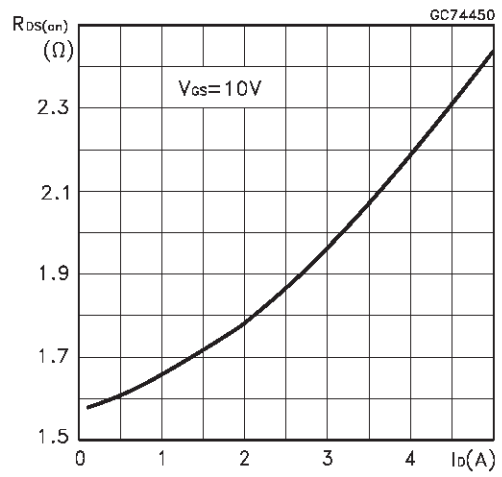

Gate Charge vs Gate-source Voltage

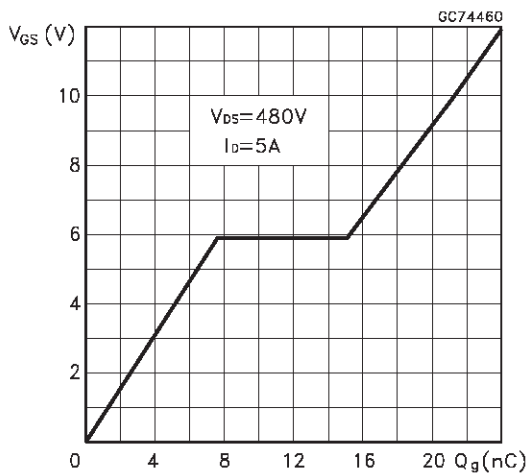

Capacitance Variations

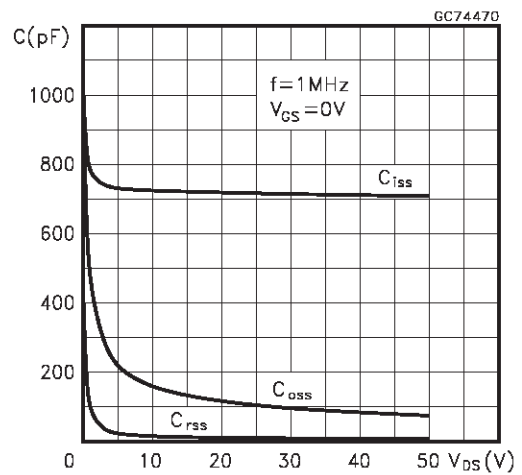

Normalized Gate Threshold Voltage vs Temperature

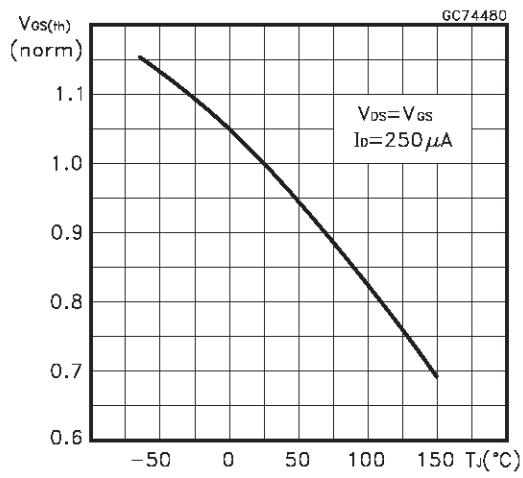

Normalized On Resistance vs Temperature

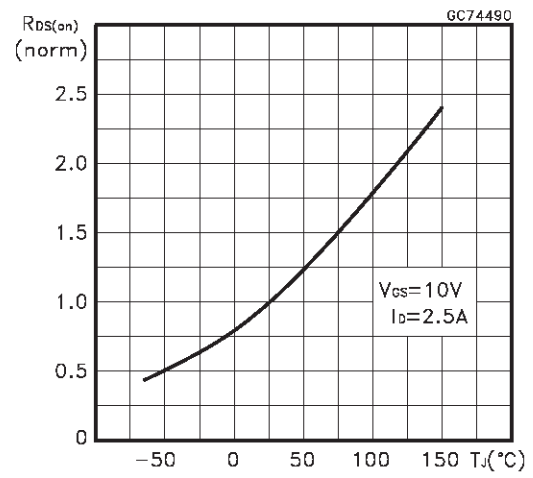

Source-drain Diode Forward Characteristics

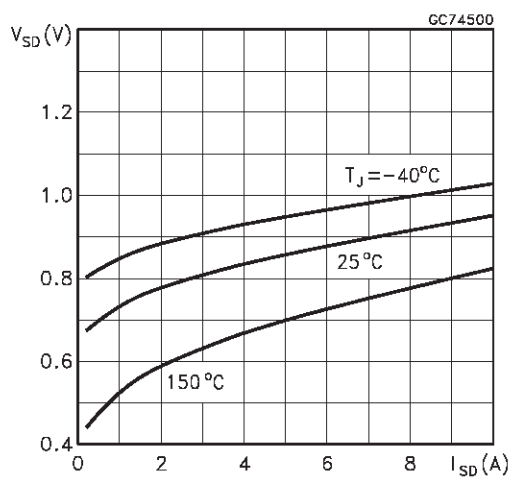

Fig. 1: Unclamped Inductive Load Test Circuit



Fig. 2: Unclamped Inductive Waveform

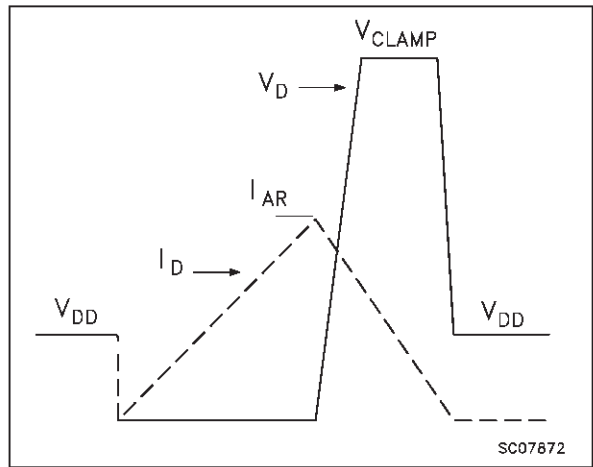

Fig. 3: Switching Times Test Circuits For Resistive Load



Fig. 4: Gate Charge test Circuit

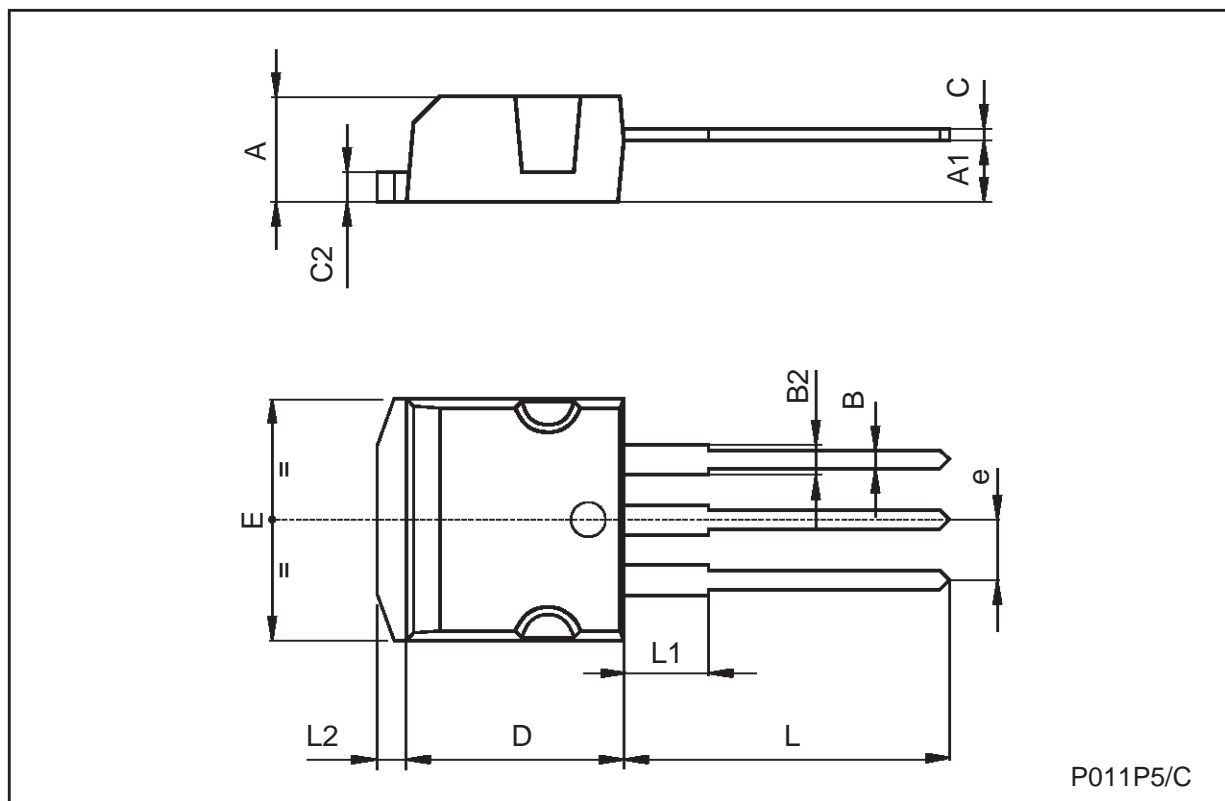

Fig. 5: Test Circuit For Inductive Load Switching And Diode Recovery Times



## TO-262 (I2PAK) MECHANICAL DATA

DIM.	mm			inch		
	MIN.	TYP.	MAX.	MIN.	TYP.	MAX.
A	4.3		4.6	0.169		0.181
A1	2.49		2.69	0.098		0.106
B	0.7		0.93	0.027		0.036
B1	1.2		1.38	0.047		0.054
B2	1.25		1.4	0.049		0.055
C	0.45		0.6	0.017		0.023
C2	1.21		1.36	0.047		0.053
D	8.95		9.35	0.352		0.368
e	2.44		2.64	0.096		0.104
E	10		10.28	0.393		0.404
L	13.2		13.5	0.519		0.531
L1	3.48		3.78	0.137		0.149
L2	1.27		1.4	0.050		0.055



**TO-263 (D<sup>2</sup>PAK) MECHANICAL DATA**

DIM.	mm			inch		
	MIN.	TYP.	MAX.	MIN.	TYP.	MAX.
A	4.3		4.6	0.169		0.181
A1	2.49		2.69	0.098		0.106
B	0.7		0.93	0.027		0.036
B2	1.25		1.4	0.049		0.055
C	0.45		0.6	0.017		0.023
C2	1.21		1.36	0.047		0.053
D	8.95		9.35	0.352		0.368
E	10		10.28	0.393		0.404
G	4.88		5.28	0.192		0.208
L	15		15.85	0.590		0.624
L2	1.27		1.4	0.050		0.055
L3	1.4		1.75	0.055		0.068

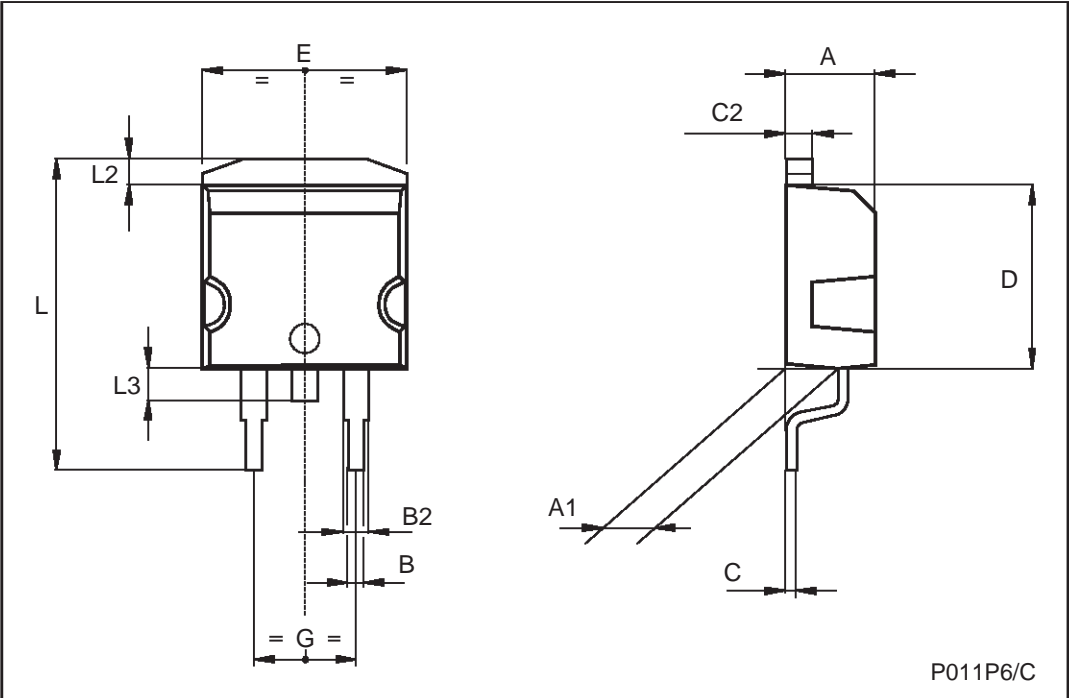



Information furnished is believed to be accurate and reliable. However, STMicroelectronics assumes no responsibility for the consequences of use of such information nor for any infringement of patents or other rights of third parties which may result from its use. No license is granted by implication or otherwise under any patent or patent rights of STMicroelectronics. Specification mentioned in this publication are subject to change without notice. This publication supersedes and replaces all information previously supplied. STMicroelectronics products are not authorized for use as critical components in life support devices or systems without express written approval of STMicroelectronics.

The ST logo is a trademark of STMicroelectronics

© 1999 STMicroelectronics – Printed in Italy – All Rights Reserved  
STMicroelectronics GROUP OF COMPANIES

Australia - Brazil - China - Finland - France - Germany - Hong Kong - India - Italy - Japan - Malaysia - Malta - Morocco -  
Singapore - Spain - Sweden - Switzerland - United Kingdom - U.S.A.

<http://www.st.com>

