Up to 6 GHz Low Noise Silicon Bipolar Transistor Chip

Technical Data

AT-41400

Features

- **Low Noise Figure:**
 - 1.6 dB Typical at 2.0 GHz
 - 3.0 dB Typical at 4.0 GHz
- **High Associated Gain:**
 - 14.5 dB Typical at 2.0 GHz
 - 10.5 dB Typical at 4.0 GHz
- **High Gain-Bandwidth Product:**
 - 9.0 GHz Typical f_T

Description

Hewlett-Packard's AT-41400 is a general purpose NPN bipolar transistor chip that offers excellent high frequency performance. The 4 micron emitter-to-emitter pitch enables this transistor to be used in many different functions. The 14 emitter finger interdigitated geometry yields an intermediate sized transistor with impedances

that are easy to match for low noise and moderate power applications. This device is designed for use in low noise, wideband amplifier, mixer and oscillator applications in the VHF, UHF, and microwave frequencies. An optimum noise match near 50Ω at 1 GHz, makes this device easy to use as a low noise amplifier.

The AT-41400 bipolar transistor is fabricated using Hewlett-Packard's 10 GHz f_T Self-Aligned-Transistor (SAT) process. The die is nitride passivated for surface protection. Excellent device uniformity, performance and reliability are produced by the use of ion-implantation, self-alignment techniques, and gold metalization in the fabrication of this device.

Chip Outline

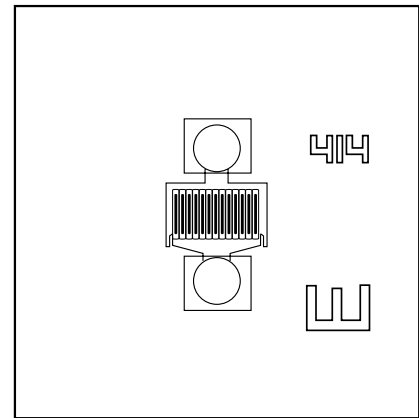

AT-41400 Absolute Maximum Ratings

Symbol	Parameter	Units	Absolute Maximum ^[1]
V _{EBO}	Emitter-Base Voltage	V	1.5
V _{CBO}	Collector-Base Voltage	V	20
V _{CEO}	Collector-Emitter Voltage	V	12
I _C	Collector Current	mA	60
P _T	Power Dissipation ^[2,3]	mW	500
T _j	Junction Temperature	°C	200
T _{STG}	Storage Temperature	°C	-65 to 200

Thermal Resistance^[2,4]:

$$\theta_{jc} = 95^{\circ}\text{C/W}$$

Notes:

1. Permanent damage may occur if any of these limits are exceeded.
2. T_{MOUNTING SURFACE} = 25°C.
3. Derate at 10.5 mW/°C for T_{MOUNTING SURFACE} > 153°C.
4. The small spot size of this technique results in a higher, though more accurate determination of θ_{jc} than do alternate methods. See MEASUREMENTS section "Thermal Resistance" for more information.

Part Number Ordering Information

Part Number	Devices Per Tray
AT-41400-GP4	100

Note: For more information, see "Tape and Reel Packaging for Semiconductor Devices".

Electrical Specifications, T_A = 25°C

Symbol	Parameters and Test Conditions ^[1]	Units	Min.	Typ.	Max.
S _{21E} ²	Insertion Power Gain; V _{CE} = 8 V, I _C = 25 mA	f = 2.0 GHz f = 4.0 GHz	dB	12.0 6.5	
P _{1 dB}	Power Output @ 1 dB Gain Compression V _{CE} = 8 V, I _C = 25 mA	f = 2.0 GHz f = 4.0 GHz	dBm	19.0 18.5	
G _{1 dB}	1 dB Compressed Gain; V _{CE} = 8 V, I _C = 25 mA	f = 2.0 GHz f = 4.0 GHz	dB	15.0 10.5	
NF _O	Optimum Noise Figure; V _{CE} = 8 V, I _C = 10 mA	f = 1.0 GHz f = 2.0 GHz f = 4.0 GHz	dB	1.3 1.6 3.0	
G _A	Gain @ NF _O ; V _{CE} = 8 V, I _C = 10 mA	f = 1.0 GHz f = 2.0 GHz f = 4.0 GHz	dB	18.5 14.5 10.5	
f _T	Gain Bandwidth Product: V _{CE} = 8 V, I _C = 25 mA		GHz	9.0	
h _{FE}	Forward Current Transfer Ratio; V _{CE} = 8 V, I _C = 10 mA		—	30	300
I _{CBO}	Collector Cutoff Current; V _{CB} = 8 V		μA		0.2
I _{EBO}	Emitter Cutoff Current; V _{EB} = 1 V		μA		1.0
C _{CB}	Collector Base Capacitance ^[2] ; V _{CB} = 8 V, f = 1 MHz		pF	0.17	

Notes:

1. RF performance is determined by packaging and testing 10 devices per wafer.
2. For this test, the emitter is grounded.

AT-41400 Typical Performance, $T_A = 25^\circ\text{C}$

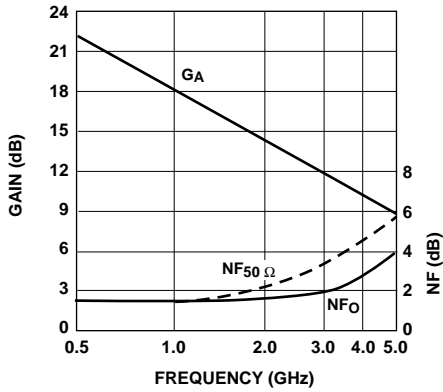

Figure 1. Noise Figure and Associated Gain vs. Frequency.
 $V_{CE} = 8\text{ V}$, $I_C = 10\text{ mA}$.

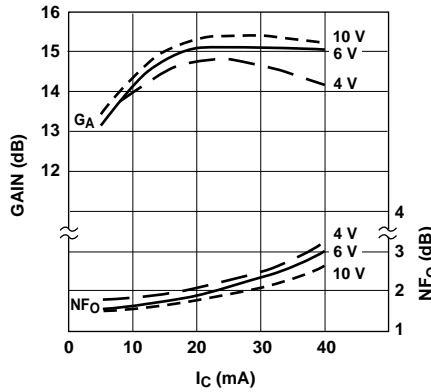

Figure 2. Optimum Noise Figure and Associated Gain vs. Collector Current and Collector Voltage. $f = 2.0\text{ GHz}$.

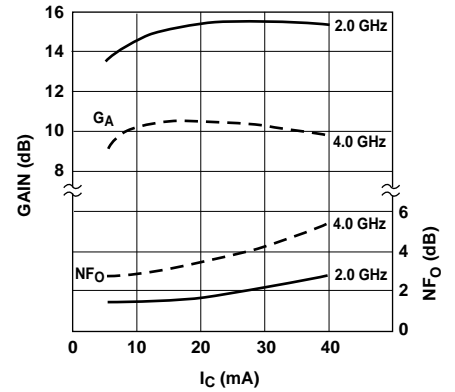

Figure 3. Optimum Noise Figure and Associated Gain vs. Collector Current and Frequency. $V_{CE} = 8\text{ V}$.

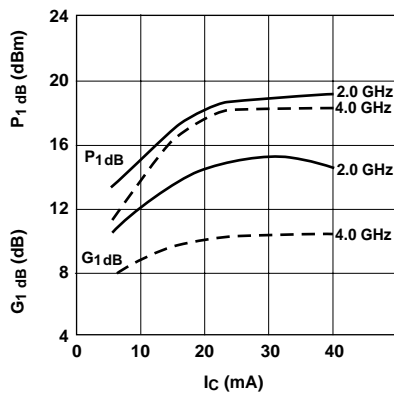

Figure 4. Output Power and 1 dB Compressed Gain vs. Collector Current. $V_{CE} = 8\text{ V}$.

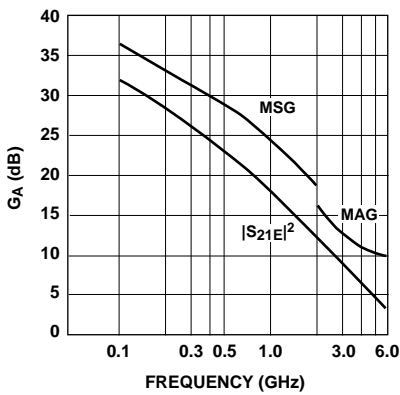

Figure 5. Insertion Power Gain, Maximum Available Gain and Maximum Stable Gain vs. Frequency.
 $V_{CE} = 8\text{ V}$, $I_C = 25\text{ mA}$.

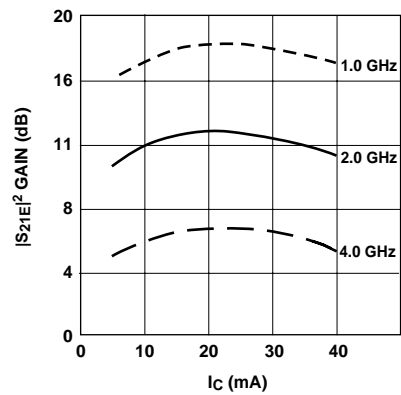

Figure 6. Insertion Power Gain vs. Collector Current and Frequency.
 $V_{CE} = 8\text{ V}$.

AT-41400 Typical Scattering Parameters,

Common Emitter, $Z_0 = 50 \Omega$, $T_A = 25^\circ\text{C}$, $V_{CE} = 8\text{V}$, $I_C = 10\text{mA}$

Freq. GHz	S_{11}		dB	S_{21}		dB	S_{12}		S_{22}	
	Mag.	Ang.		Mag.	Ang.		Mag.	Ang.	Mag.	Ang.
0.1	.73	-39	28.3	25.84	159	-39.2	.011	75	.94	-12
0.5	.60	-121	22.2	12.91	113	-30.2	.031	48	.61	-28
1.0	.57	-156	17.2	7.27	94	-28.0	.040	51	.50	-25
1.5	.56	-172	13.7	4.84	84	-26.4	.048	59	.47	-25
2.0	.57	176	11.4	3.71	77	-24.9	.057	66	.46	-24
2.5	.57	170	9.5	2.97	71	-23.6	.066	69	.46	-26
3.0	.60	164	8.0	2.52	64	-22.3	.077	72	.45	-28
3.5	.60	157	6.8	2.18	61	-20.9	.090	77	.47	-29
4.0	.61	152	5.5	1.89	55	-20.1	.099	79	.47	-30
4.5	.63	147	4.7	1.72	51	-18.7	.116	81	.47	-36
5.0	.63	144	3.7	1.53	46	-17.8	.129	80	.48	-40
5.5	.65	139	3.1	1.42	42	-17.0	.141	82	.49	-44
6.0	.66	136	2.1	1.28	38	-16.1	.156	83	.50	-47

AT-41400 Typical Scattering Parameters,

Common Emitter, $Z_0 = 50 \Omega$, $T_A = 25^\circ\text{C}$, $V_{CE} = 8\text{V}$, $I_C = 25\text{mA}$

Freq. GHz	S_{11}		dB	S_{21}		dB	S_{12}		S_{22}	
	Mag.	Ang.		Mag.	Ang.		Mag.	Ang.	Mag.	Ang.
0.1	.56	-60	31.8	39.07	152	-40.9	.009	69	.87	-18
0.5	.54	-145	23.5	15.00	104	-32.8	.023	56	.49	-28
1.0	.54	-170	18.1	8.03	90	-29.6	.033	65	.42	-23
1.5	.55	179	14.5	5.30	82	-26.9	.045	72	.41	-22
2.0	.56	170	12.1	4.04	76	-24.7	.058	75	.41	-23
2.5	.56	165	10.2	3.24	72	-23.1	.070	78	.40	-23
3.0	.58	159	8.8	2.75	65	-21.6	.083	79	.40	-25
3.5	.59	154	7.5	2.37	62	-20.4	.096	82	.41	-26
4.0	.60	149	6.3	2.06	57	-19.3	.108	83	.42	-28
4.5	.61	145	5.4	1.87	53	-18.1	.124	84	.42	-33
5.0	.62	142	4.5	1.67	49	-17.3	.136	83	.43	-36
5.5	.64	137	3.8	1.54	44	-16.5	.150	85	.42	-40
6.0	.65	134	2.9	1.40	41	-15.7	.165	84	.44	-45

A model for this device is available in the DEVICE MODELS section.

AT-41400 Noise Parameters: $V_{CE} = 8\text{V}$, $I_C = 10\text{mA}$

Freq. GHz	NF_0 dB	Γ_{opt}		$R_N/50$
		Mag	Ang	
0.1	1.2	.12	3	0.17
0.5	1.2	.10	15	0.17
1.0	1.3	.06	27	0.16
2.0	1.6	.24	163	0.16
4.0	3.0	.52	-153	0.18

AT-41400 Chip Dimensions

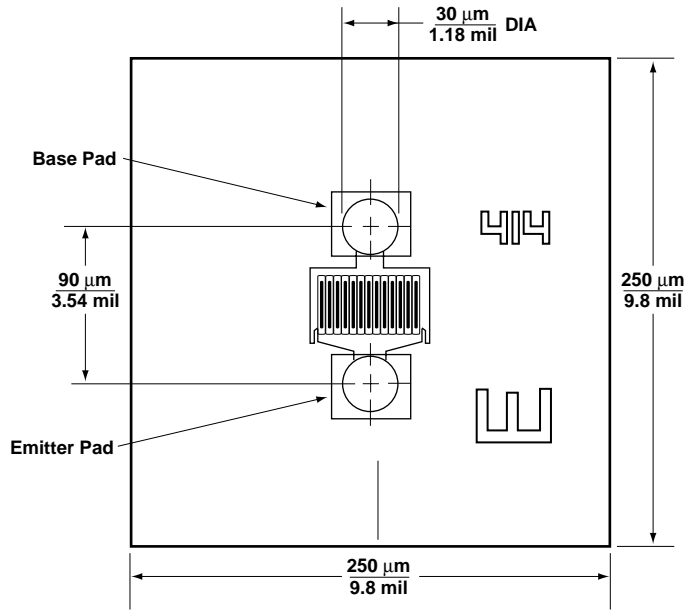

Note: Die thickness is 5 to 6 mil.