

## GaAs/GaAlAs IR Emitting Diode in $\varnothing$ 5 mm (T-1 $\frac{3}{4}$ ) Package

### Description

TSAL7300 is a high efficiency infrared emitting diode in GaAlAs on GaAs technology, molded in clear, plastic packages.

In comparison with the standard GaAs on GaAs technology these emitters achieve more than 100 % radiant power improvement at a similar wavelength.

The forward voltages at low current and at high pulse current roughly correspond to the low values of the standard technology. Therefore these emitters are ideally suitable as high performance replacements of standard emitters.

94 8389

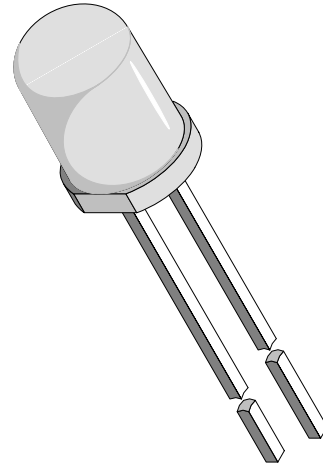

### Features

- Extra high radiant power and radiant intensity
- Low forward voltage
- Suitable for high pulse current operation
- Standard T-1 $\frac{3}{4}$  ( $\varnothing$  5 mm) package
- Angle of half intensity  $\varphi = \pm 22^\circ$
- Peak wavelength  $\lambda_p = 940$  nm
- High reliability
- Good spectral matching to Si photodetectors

### Applications

Infrared remote control units with high power requirements

Free air transmission systems

Infrared source for optical counters and card readers

IR source for smoke detectors

### Absolute Maximum Ratings

$T_{amb} = 25^{\circ}\text{C}$

Parameter	Test Conditions	Symbol	Value	Unit
Reverse Voltage		$V_R$	5	V
Forward Current		$I_F$	100	mA
Peak Forward Current	$t_p/T = 0.5$ , $t_p = 100 \mu\text{s}$	$I_{FM}$	200	mA
Surge Forward Current	$t_p = 100 \mu\text{s}$	$I_{FSM}$	1,5	A
Power Dissipation		$P_V$	210	mW
Junction Temperature		$T_j$	100	$^{\circ}\text{C}$
Operating Temperature Range		$T_{amb}$	-55...+100	$^{\circ}\text{C}$
Storage Temperature Range		$T_{stg}$	-55...+100	$^{\circ}\text{C}$
Soldering Temperature	$t \leq 5\text{sec}$ , 2 mm from case	$T_{sd}$	260	$^{\circ}\text{C}$
Thermal Resistance Junction/Ambient		$R_{thJA}$	350	K/W

### Basic Characteristics

$T_{amb} = 25^{\circ}\text{C}$

Parameter	Test Conditions	Symbol	Min	Typ	Max	Unit
Forward Voltage	$I_F = 100 \text{ mA}$ , $t_p = 20 \text{ ms}$	$V_F$		1.35	1.6	V
	$I_F = 1 \text{ A}$ , $t_p = 100 \mu\text{s}$	$V_F$		2.6	3	V
Temp. Coefficient of $V_F$	$I_F = 100 \text{ mA}$	$TK_{V_F}$		-1.875		mV/K
Reverse Current	$V_R = 5 \text{ V}$	$I_R$			10	$\mu\text{A}$
Junction Capacitance	$V_R = 0$ , $f = 1 \text{ MHz}$ , $E = 0$	$C_j$		25		pF
Radiant Intensity	$I_F = 100 \text{ mA}$ , $t_p = 20 \text{ ms}$	$I_e$	30	45		mW/sr
	$I_F = 1 \text{ A}$ , $t_p = 100 \mu\text{s}$	$I_e$	260	350		mW/sr
Radiant Power	$I_F = 100 \text{ mA}$ , $t_p = 20 \text{ ms}$	$\phi_e$		35		mW
Temp. Coefficient of $\phi_e$	$I_F = 20 \text{ mA}$	$TK_{\phi_e}$		-0.6		%/K
Angle of Half Intensity		$\phi$		$\pm 22$		deg
Peak Wavelength	$I_F = 100 \text{ mA}$	$\lambda_p$		940		nm
Spectral Bandwidth	$I_F = 100 \text{ mA}$	$\Delta\lambda$		50		nm
Temp. Coefficient of $\lambda_p$	$I_F = 100 \text{ mA}$	$TK_{\lambda_p}$		0.2		nm/K
Rise Time	$I_F = 100 \text{ mA}$	$t_r$		800		ns
	$I_F = 1 \text{ A}$	$t_r$		500		ns
Fall Time	$I_F = 100 \text{ mA}$	$t_f$		800		ns
	$I_F = 1 \text{ A}$	$t_f$		500		ns
Virtual Source Diameter	method: 63% encircled energy	$\emptyset$		2.1		mm

**Typical Characteristics** ( $T_{amb} = 25^{\circ}\text{C}$  unless otherwise specified)

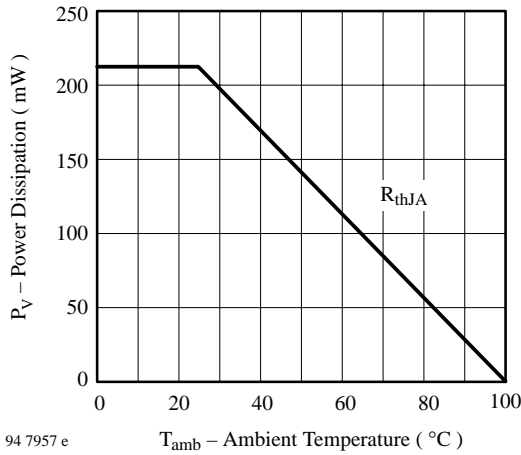

Figure 1. Power Dissipation vs. Ambient Temperature

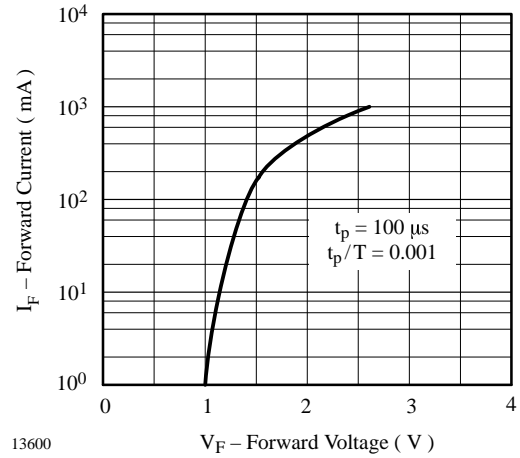

Figure 4. Forward Current vs. Forward Voltage

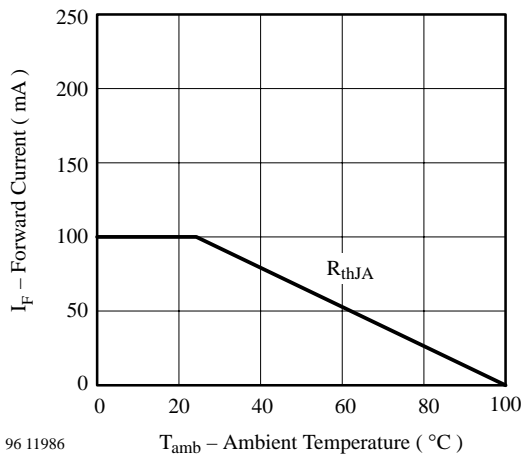

Figure 2. Forward Current vs. Ambient Temperature

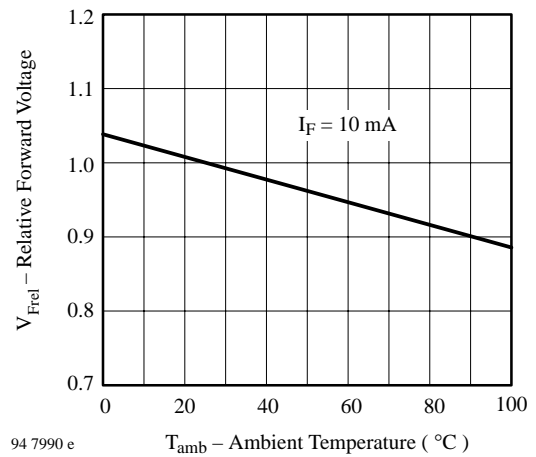

Figure 5. Relative Forward Voltage vs. Ambient Temperature

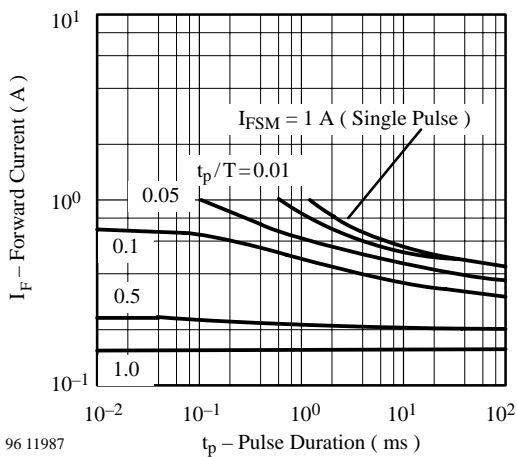

Figure 3. Pulse Forward Current vs. Pulse Duration

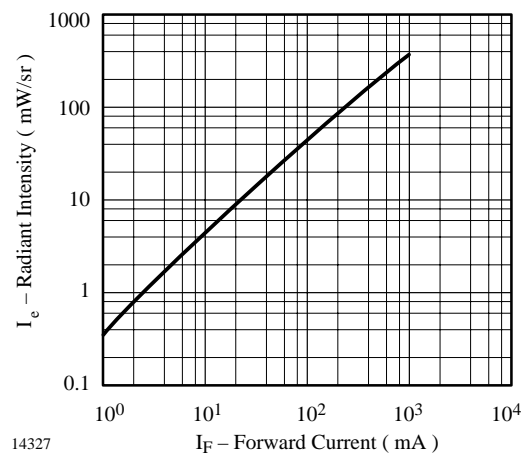

Figure 6. Radiant Intensity vs. Forward Current

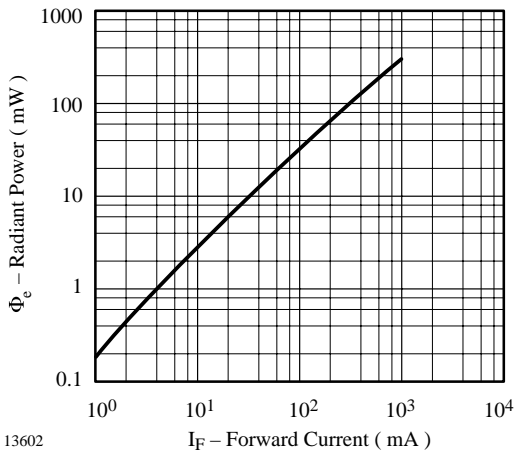

Figure 7. Radiant Power vs. Forward Current

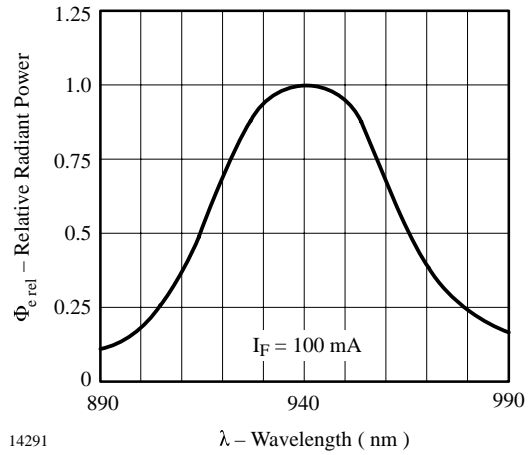

Figure 9. Relative Radiant Power vs. Wavelength

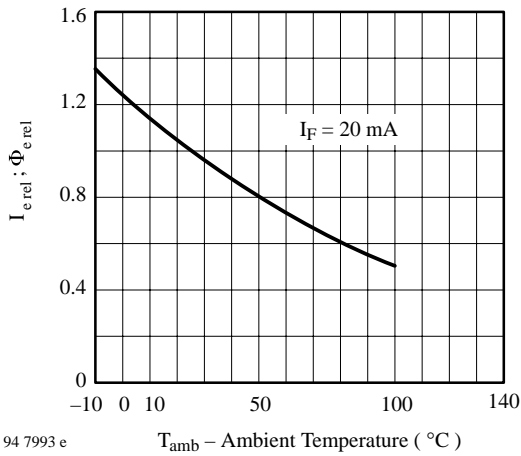

Figure 8. Rel. Radiant Intensity/Power vs. Ambient Temperature

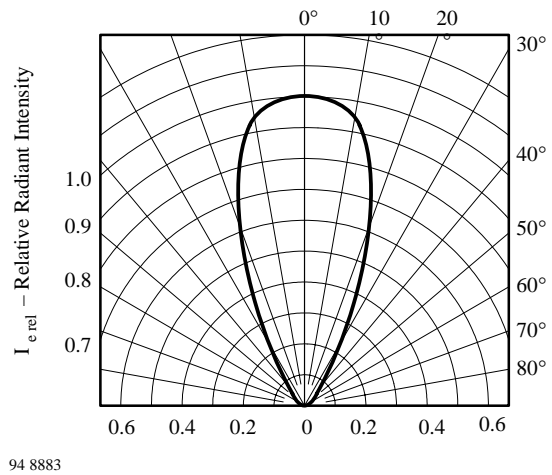
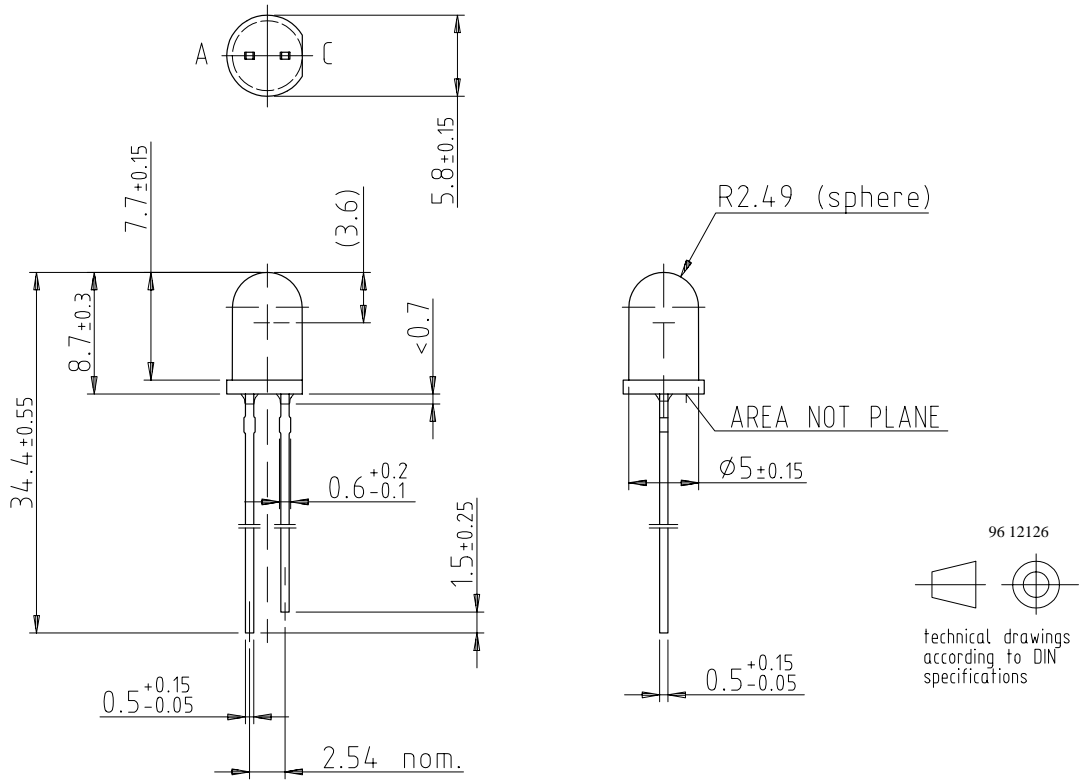

Figure 10. Relative Radiant Intensity vs. Angular Displacement

**Dimensions in mm**



### Ozone Depleting Substances Policy Statement

It is the policy of **Vishay Semiconductor GmbH** to

1. Meet all present and future national and international statutory requirements.
2. Regularly and continuously improve the performance of our products, processes, distribution and operating systems with respect to their impact on the health and safety of our employees and the public, as well as their impact on the environment.

It is particular concern to control or eliminate releases of those substances into the atmosphere which are known as ozone depleting substances (ODSs).

The Montreal Protocol (1987) and its London Amendments (1990) intend to severely restrict the use of ODSs and forbid their use within the next ten years. Various national and international initiatives are pressing for an earlier ban on these substances.

**Vishay Semiconductor GmbH** has been able to use its policy of continuous improvements to eliminate the use of ODSs listed in the following documents.

1. Annex A, B and list of transitional substances of the Montreal Protocol and the London Amendments respectively
2. Class I and II ozone depleting substances in the Clean Air Act Amendments of 1990 by the Environmental Protection Agency (EPA) in the USA
3. Council Decision 88/540/EEC and 91/690/EEC Annex A, B and C (transitional substances) respectively.

**Vishay Semiconductor GmbH** can certify that our semiconductors are not manufactured with ozone depleting substances and do not contain such substances.

**We reserve the right to make changes to improve technical design and may do so without further notice.**

Parameters can vary in different applications. All operating parameters must be validated for each customer application by the customer. Should the buyer use Vishay-Telefunken products for any unintended or unauthorized application, the buyer shall indemnify Vishay-Telefunken against all claims, costs, damages, and expenses, arising out of, directly or indirectly, any claim of personal damage, injury or death associated with such unintended or unauthorized use.

Vishay Semiconductor GmbH, P.O.B. 3535, D-74025 Heilbronn, Germany  
Telephone: 49 (0) 7131 67 2831, Fax number: 49 (0) 7131 67 2423