

April 1995

Features

- 10A and 12A, 400V and 500V
- $V_{CE(ON)}$: 2.5V Max.
- T_{FI} : 1 μ s, 0.5 μ s
- Low On-State Voltage
- Fast Switching Speeds
- High Input Impedance
- No Anti-Parallel Diode

Applications

- Power Supplies
- Motor Drives
- Protection Circuits

Description

The HGTH12N40C1, HGTH12N40E1, HGTH12N50C1, HGTH12N50E1, HGTP10N40C1, HGTP10N40E1, HGTP10N50C1 and HGTP10N50E1 are n-channel enhancement-mode insulated gate bipolar transistors (IGBTs) designed for high-voltage, low on-dissipation applications such as switching regulators and motor drivers. These types can be operated directly from low-power integrated circuits.

PACKAGING AVAILABILITY

PART NUMBER	PACKAGE	BRAND
HGTH12N40C1	TO-218AC	G12N40C1
HGTH12N40E1	TO-218AC	G12N40E1
HGTH12N50C1	TO-218AC	G12N50C1
HGTH12N50E1	TO-218AC	G12N50E1
HGTP10N40C1	TO-220AB	G10N40C1
HGTP10N40E1	TO-220AB	G10N40E1
HGTP10N50C1	TO-220AB	G10N50C1
HGTP10N50E1	TO-220AB	G10N50E1

NOTE: When ordering, use the entire part number.

Packages

HGTH-TYPES JEDEC TO-218AC

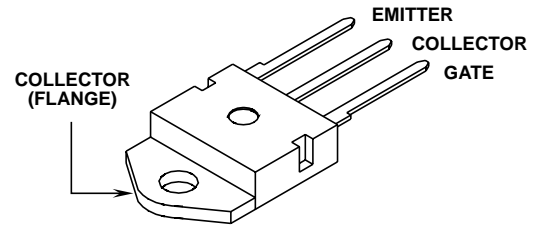

HGTP-TYPES JEDEC TO-220AB

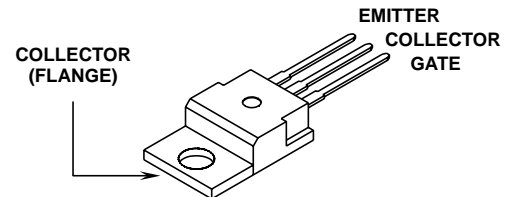

Terminal Diagram

N-CHANNEL ENHANCEMENT MODE

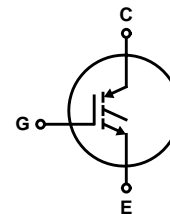

Absolute Maximum Ratings $T_C = +25^\circ\text{C}$, Unless Otherwise Specified

	HGTH12N40C1 HGTH12N40E1	HGTH12N50C1 HGTH12N50E1	HGTP10N40C1 HGTP10N40E1	HGTP10N50C1 HGTP10N50E1	UNITS
Collector-Emitter Voltage..... V_{CES}	400	500	400	500	V
Collector-Gate Voltage $R_{GE} = 1M\Omega$ V_{CGR}	400	500	400	500	V
Reverse Collector-Emitter Voltage..... $V_{ECS}(rev.)$	15	15	-5	-5	V
Gate-Emitter Voltage..... V_{GE}	± 20	± 20	± 20	± 20	V
Collector Current Continuous..... I_C	12	12	10	10	A
Collector Current Pulsed..... I_{CM}	17.5	17.5	17.5	17.5	A
Power Dissipation at $T_C = +25^\circ\text{C}$ P_D	75	75	60	60	W
Power Dissipation Derating Above $T_C > +25^\circ\text{C}$	0.6	0.6	0.48	0.48	W/ $^\circ\text{C}$
Operating and Storage Junction Temperature Range... T_J, T_{STG}	-55 to +150	-55 to +150	-55 to +150	-55 to +150	$^\circ\text{C}$

Specifications HGTP10N40C1, 40E1, 50C1, 50E1, HGTH12N40C1, 40E1, 50C1, 50E1

Electrical Specifications $T_C = +25^\circ\text{C}$, Unless Otherwise Specified

PARAMETERS	SYMBOL	TEST CONDITIONS	LIMITS				UNITS	
			HGTH12N40C1, E1, HGTP10N40C1, E1		HGTH12N50C1, E1, HGTP10N50C1, E1			
			MIN	MAX	MIN	MAX		
Collector-Emitter Breakdown Voltage	BV_{CES}	$I_C = 1\text{mA}, V_{GE} = 0$	400	-	500	-	V	
Gate Threshold Voltage	$V_{GE(TH)}$	$V_{GE} = V_{CE}, I_C = 1\text{mA}$	2.0	4.5 3 (Typ)	2.0	4.5 3 (Typ)	V	
Zero Gate Voltage Collector Current	I_{CES}	$V_{CE} = 400\text{V}, T_C = +25^\circ\text{C}$	-	250	-	-	μA	
		$V_{CE} = 500\text{V}, T_C = +25^\circ\text{C}$	-	-	-	250	μA	
		$V_{CE} = 400\text{V}, T_C = +125^\circ\text{C}$	-	1000	-	-	μA	
		$V_{CE} = 500\text{V}, T_C = +125^\circ\text{C}$	-	-	-	1000	μA	
Gate-Emitter Leakage Current	I_{GES}	$V_{GE} = \pm 20\text{V}, V_{CE} = 0$	-	100	-	100	nA	
Collector-Emitter on Voltage	$V_{CE(ON)}$	$I_C = 10\text{A}, V_{GE} = 10\text{V}$	-	2.5	-	2.5	V	
		$I_C = 17.5\text{A}, V_{GE} = 20\text{V}$	-	3.2	-	3.2	V	
Gate-Emitter Plateau Voltage	V_{GEP}	$I_C = 5\text{A}, V_{CE} = 10\text{V}$	-	6 (Typ)	-	6 (Typ)	V	
On-State Gate Charge	$Q_{G(ON)}$	$I_C = 5\text{A}, V_{CE} = 10\text{V}$	-	19 (Typ)	-	19 (Typ)	nC	
Turn-On Delay Time	$t_{D(ON)}$	$I_C = 10\text{A}, V_{CE(CL P)} = 300\text{V},$ $L = 50\mu\text{H}, T_J = +100^\circ\text{C},$ $V_{GE} = 10\text{V}, R_G = 50\Omega$	-	50	-	50	ns	
Rise Time	t_{RI}		-	50	-	50	ns	
Turn-Off Delay Time	$t_{D(OFF)}$		-	400	-	400	ns	
Fall Time	t_{FI}		40E1, 50E1	680 (Typ)	1000	680 (Typ)	1000	ns
			40C1, 50C1	400	500	400	500	ns
Turn-Off Energy Loss per Cycle (Off Switching Dissipation = $W_{OFF} \times \text{Frequency}$)	W_{OFF}	$I_C = 10\text{A}, V_{CE(CL P)} = 300\text{V},$ $L = 50\mu\text{H}, T_J = +100^\circ\text{C},$ $V_{GE} = 10\text{V}, R_G = 50\Omega$	680 (Typ)				μJ	
			400 (Typ)				μJ	
Thermal Resistance Junction-to-Case	$R_{\theta JC}$	HGTH, HGTM	-	1.67	-	1.67	$^\circ\text{C/W}$	
		HGTP	-	2.083	-	2.083	$^\circ\text{C/W}$	

INTERSIL CORPORATION IGBT PRODUCT IS COVERED BY ONE OR MORE OF THE FOLLOWING U.S. PATENTS:

4,364,073	4,417,385	4,430,792	4,443,931	4,466,176	4,516,143	4,532,534	4,567,641
4,587,713	4,598,461	4,605,948	4,618,872	4,620,211	4,631,564	4,639,754	4,639,762
4,641,162	4,644,637	4,682,195	4,684,413	4,694,313	4,717,679	4,743,952	4,783,690
4,794,432	4,801,986	4,803,533	4,809,045	4,809,047	4,810,665	4,823,176	4,837,606
4,860,080	4,883,767	4,888,627	4,890,143	4,901,127	4,904,609	4,933,740	4,963,951
4,969,027							

Typical Performance Curves

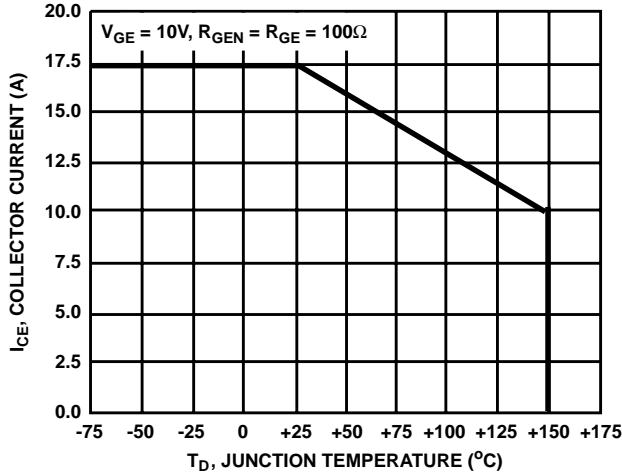

FIGURE 1. MAX. SWITCHING CURRENT LEVEL. $R_G = 50\Omega$, $V_{GE} = 0V$ ARE THE MIN. ALLOWABLE VALUES

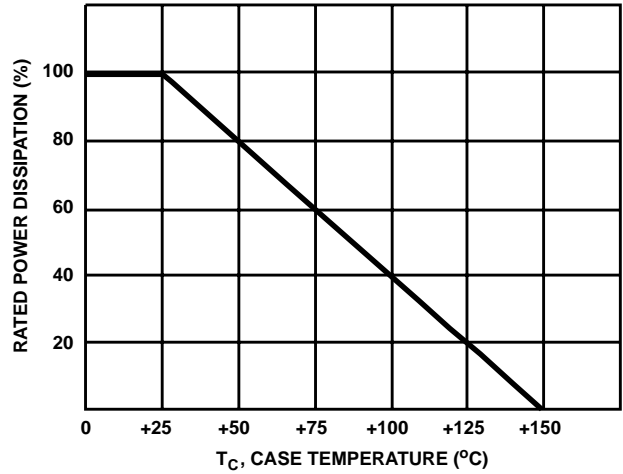

FIGURE 2. POWER DISSIPATION vs TEMPERATURE DERATING CURVE

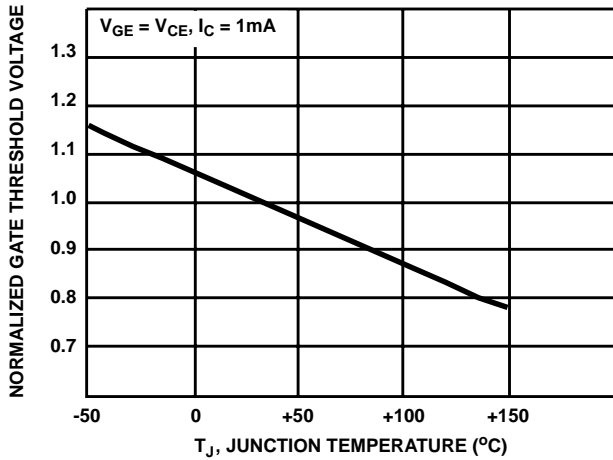

FIGURE 3. TYPICAL NORMALIZED GATE THRESHOLD VOLTAGE vs JUNCTION TEMPERATURE

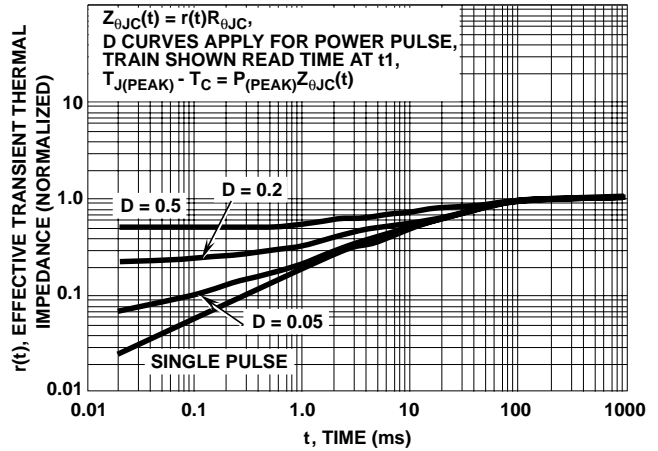

FIGURE 4. NORMALIZED THERMAL RESPONSE CHARACTERISTICS

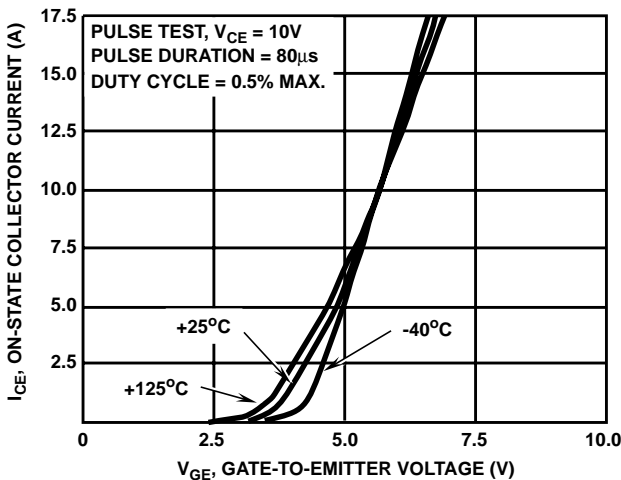

FIGURE 5. TYPICAL TRANSFER CHARACTERISTICS

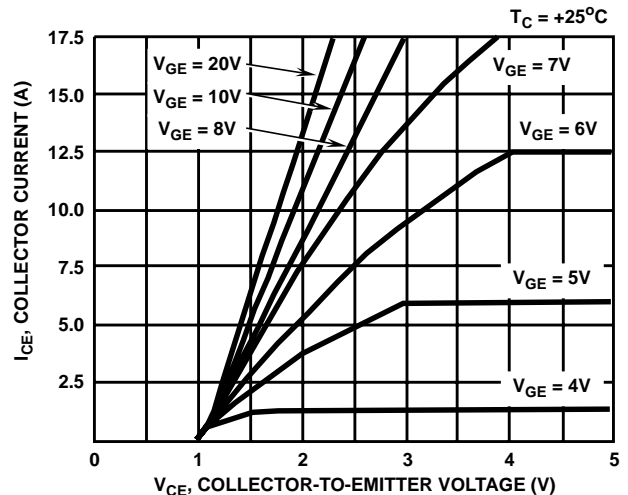

FIGURE 6. TYPICAL SATURATION CHARACTERISTICS

Typical Performance Curves (Continued)

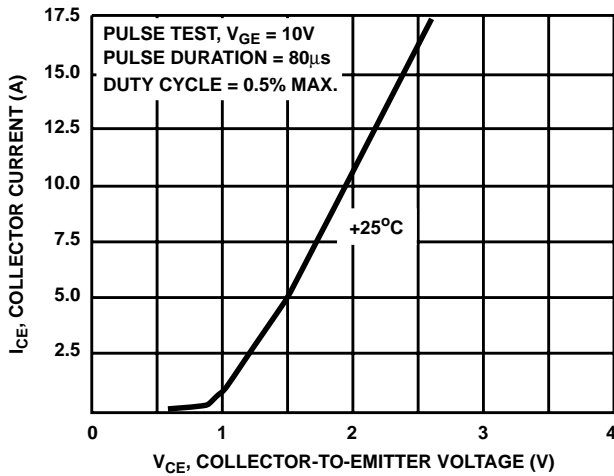

FIGURE 7. TYPICAL COLLECTOR-TO-EMITTER ON-VOLTAGE vs COLLECTOR CURRENT

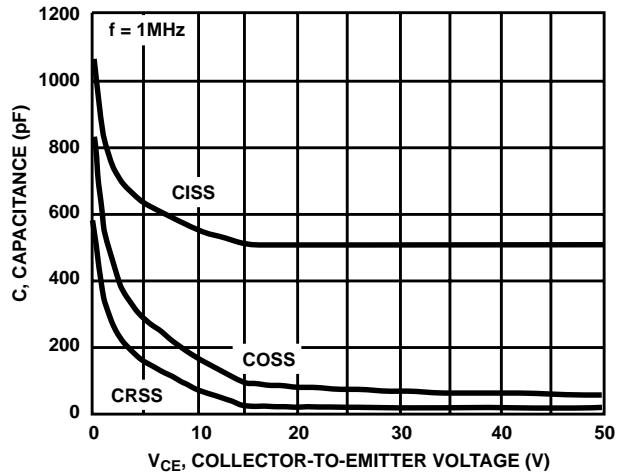

FIGURE 8. CAPACITANCE vs COLLECTOR-TO-EMITTER VOLTAGE

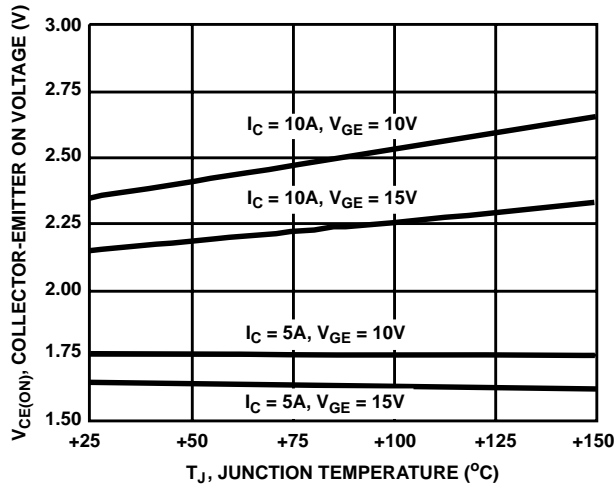

FIGURE 9. TYPICAL $V_{CE(ON)}$ vs TEMPERATURE

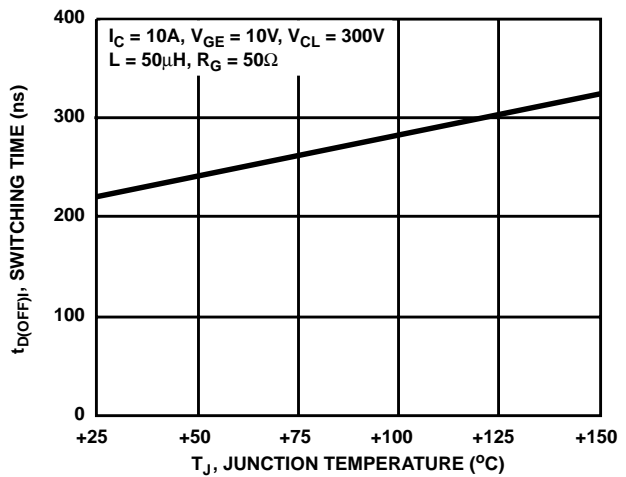

FIGURE 10. TYPICAL TURN-OFF DELAY TIME

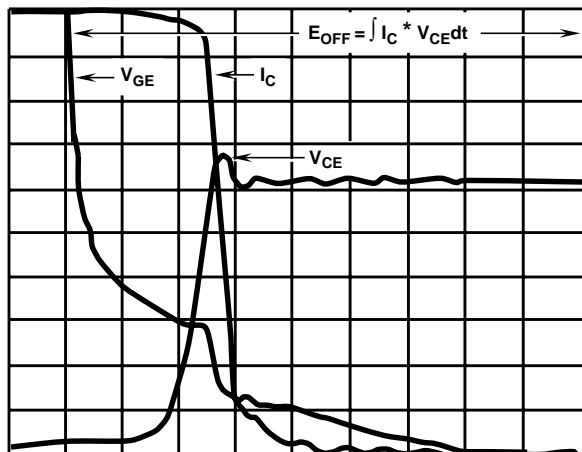

FIGURE 11. TYPICAL INDUCTIVE SWITCHING WAVEFORMS

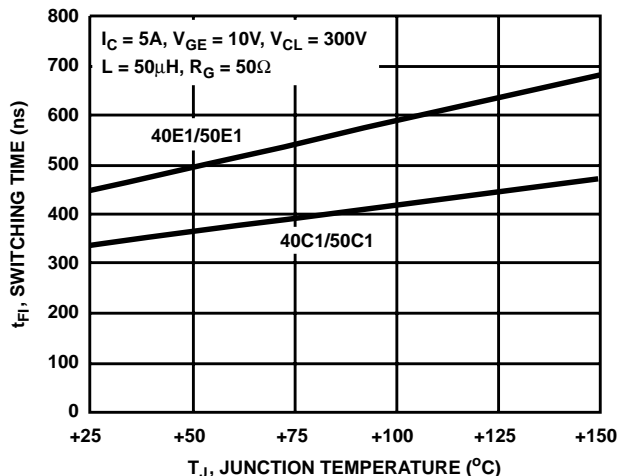

FIGURE 12. TYPICAL FALL TIME ($I_C = 5A$)

Typical Performance Curves (Continued)

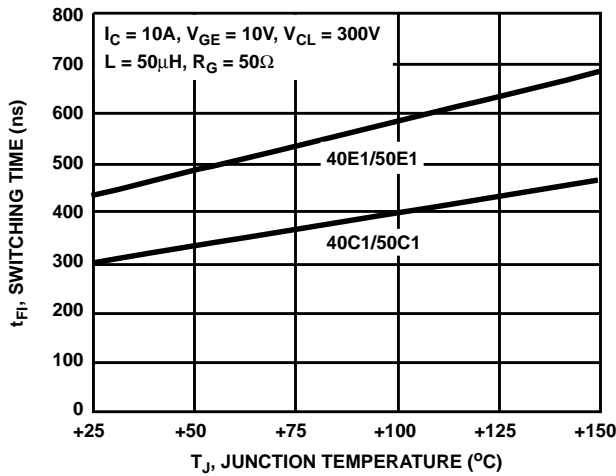

FIGURE 13. TYPICAL FALL TIME ($I_C = 10A$)

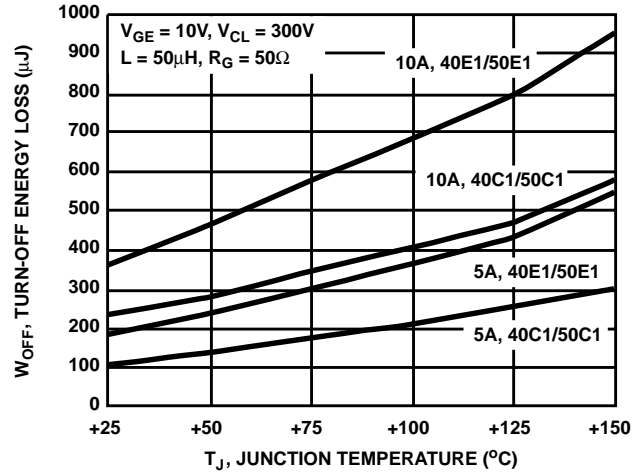

FIGURE 14. TYPICAL CLAMPED INDUCTIVE TURN-OFF SWITCHING LOSS/CYCLE

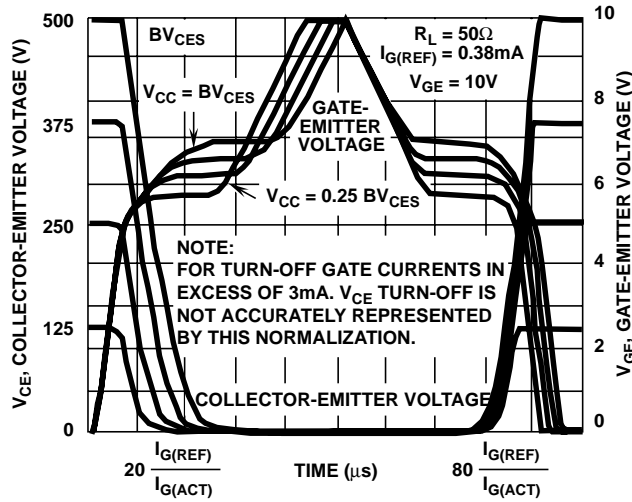

FIGURE 15. NORMALIZED SWITCHING WAVEFORMS AT CONSTANT GATE CURRENT

Test Circuit

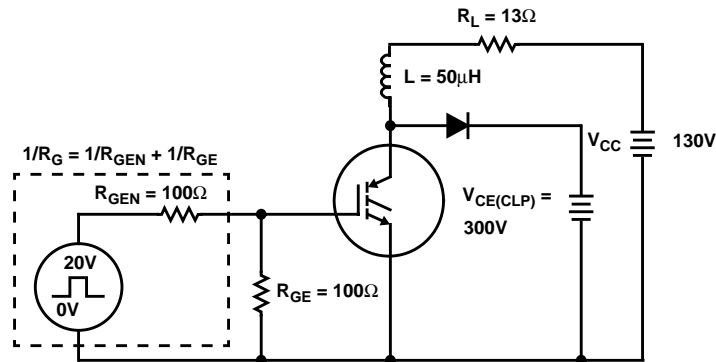

FIGURE 16. INDUCTIVE SWITCHING TEST CIRCUIT

All Intersil semiconductor products are manufactured, assembled and tested under **ISO9000** quality systems certification.

Intersil products are sold by description only. Intersil Corporation reserves the right to make changes in circuit design and/or specifications at any time without notice. Accordingly, the reader is cautioned to verify that data sheets are current before placing orders. Information furnished by Intersil is believed to be accurate and reliable. However, no responsibility is assumed by Intersil or its subsidiaries for its use; nor for any infringements of patents or other rights of third parties which may result from its use. No license is granted by implication or otherwise under any patent or patent rights of Intersil or its subsidiaries.

For information regarding Intersil Corporation and its products, see web site <http://www.intersil.com>

Sales Office Headquarters

NORTH AMERICA

Intersil Corporation
P. O. Box 883, Mail Stop 53-204
Melbourne, FL 32902
TEL: (407) 724-7000
FAX: (407) 724-7240

EUROPE

Intersil SA
Mercure Center
100, Rue de la Fusee
1130 Brussels, Belgium
TEL: (32) 2.724.2111
FAX: (32) 2.724.22.05

ASIA

Intersil (Taiwan) Ltd.
Taiwan Limited
7F-6, No. 101 Fu Hsing North Road
Taipei, Taiwan
Republic of China
TEL: (886) 2 2716 9310
FAX: (886) 2 2715 3029

