

Bias Resistor Transistors

NPN Silicon Surface Mount Transistors with Monolithic Bias Resistor Network

This new series of digital transistors is designed to replace a single device and its external resistor bias network. The BRT (Bias Resistor Transistor) contains a single transistor with a monolithic bias network consisting of two resistors; a series base resistor and a base-emitter resistor. The BRT eliminates these individual components by integrating them into a single device. The use of a BRT can reduce both system cost and board space. The device is housed in the SC-59 package which is designed for low power surface mount applications.

- Simplifies Circuit Design
- Reduces Board Space
- Reduces Component Count
- Moisture Sensitivity Level: 1
- ESD Rating – Human Body Model: Class 1
– Machine Model: Class B
- The SC-59 package can be soldered using wave or reflow. The modified gull-winged leads absorb thermal stress during soldering eliminating the possibility of damage to the die.
- Available in 8 mm embossed tape and reel
Use the Device Number to order the 7 inch/3000 unit reel.

MUN2211T1 SERIES

NPN SILICON BIAS RESISTOR TRANSISTORS



SC-59
CASE 318D, STYLE 1

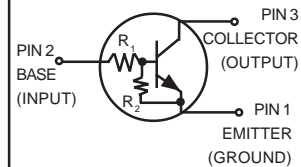

DEVICE MARKING INFORMATION

*See specific marking information in the device marking table on page 2 of this data sheet.

MARKING DIAGRAM

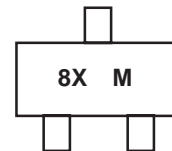

8X = Specific Device Code*
M = Date Code

MAXIMUM RATINGS (T_A = 25°C unless otherwise noted)

Rating	Symbol	Value	Unit
Collector-Base Voltage	V _{CBO}	50	Vdc
Collector-Emitter Voltage	V _{CEO}	50	Vdc
Collector Current	I _c	100	mAdc

THERMAL CHARACTERISTICS

Characteristic	Symbol	Max	Unit
Total Device Dissipation	P _D	230(Note 1)	mW
T _A = 25°C		338(Note 2)	
Derate above 25°C		1.8 (Note 1)	°C/W
		2.7 (Note 2)	
Thermal Resistance – Junction-to-Ambient	R _{θJA}	540(Note 1)	°C/W
		370(Note 2)	
Thermal Resistance – Junction-to-Lead	R _{θJL}	264(Note 1)	°C/W
		287(Note 2)	
Junction and Storage Temperature Range	T _J , T _{stg}	-55 to +150	°C

1. FR-4 @ Minimum Pad
2. FR-4 @ 1.0 x 1.0 inch Pad

MUN2211T1 Series**DEVICE MARKING AND RESISTOR VALUES**

Device	Package	Marking	R1 (K)	R2 (K)	Shipping
MUN2211T1	SC-59	8A	10	10	3000/Tape & Reel
MUN2212T1	SC-59	8B	22	22	3000/Tape & Reel
MUN2213T1	SC-59	8C	47	47	3000/Tape & Reel
MUN2214T1	SC-59	8D	10	47	3000/Tape & Reel
MUN2215T1 (Note 3)	SC-59	8E	10	∞	3000/Tape & Reel
MUN2216T1 (Note 3)	SC-59	8F	4.7	∞	3000/Tape & Reel
MUN2230T1 (Note 3)	SC-59	8G	1.0	1.0	3000/Tape & Reel
MUN2231T1 (Note 3)	SC-59	8H	2.2	2.2	3000/Tape & Reel
MUN2232T1 (Note 3)	SC-59	8J	4.7	4.7	3000/Tape & Reel
MUN2233T1 (Note 3)	SC-59	8K	4.7	47	3000/Tape & Reel
MUN2234T1 (Note 3)	SC-59	8L	22	47	3000/Tape & Reel
MUN2236T1	SC-59	8N	100	100	3000/Tape & Reel
MUN2237T1	SC-59	8P	47	22	3000/Tape & Reel
MUN2240T1 (Note 3)	SC-59	8T	47	∞	3000/Tape & Reel
MUN2241T1 (Note 3)	SC-59	8U	100	∞	3000/Tape & Reel

3. New devices. Updated curves to follow in subsequent data sheets.

MUN2211T1 Series

ELECTRICAL CHARACTERISTICS ($T_A = 25^\circ\text{C}$ unless otherwise noted)

Characteristic	Symbol	Min	Typ	Max	Unit
OFF CHARACTERISTICS					
Collector-Base Cutoff Current ($V_{CB} = 50\text{ V}$, $I_E = 0$)	I_{CBO}	–	–	100	nAdc
Collector-Emitter Cutoff Current ($V_{CE} = 50\text{ V}$, $I_B = 0$)	I_{CEO}	–	–	500	nAdc
Emitter-Base Cutoff Current ($V_{EB} = 6.0\text{ V}$, $I_C = 0$)	I_{EBO}	–	–	0.5	mAdc
MUN2211T1		–	–	0.2	
MUN2212T1		–	–	0.1	
MUN2213T1		–	–	0.2	
MUN2214T1		–	–	0.9	
MUN2215T1		–	–	1.9	
MUN2216T1		–	–	4.3	
MUN2230T1		–	–	2.3	
MUN2231T1		–	–	1.5	
MUN2232T1		–	–	0.18	
MUN2233T1		–	–	0.13	
MUN2234T1		–	–	0.05	
MUN2236T1		–	–	0.13	
MUN2237T1		–	–	0.2	
MUN2240T1		–	–	0.1	
MUN2241T1		–	–		
Collector-Base Breakdown Voltage ($I_C = 10\ \mu\text{A}$, $I_E = 0$)	$V_{(BR)CBO}$	50	–	–	Vdc
Collector-Emitter Breakdown Voltage (Note 4) ($I_C = 2.0\text{ mA}$, $I_B = 0$)	$V_{(BR)CEO}$	50	–	–	Vdc

ON CHARACTERISTICS (Note 4)

DC Current Gain ($V_{CE} = 10\text{ V}$, $I_C = 5.0\text{ mA}$)	MUN2211T1 MUN2212T1 MUN2213T1 MUN2214T1 MUN2215T1 MUN2216T1 MUN2230T1 MUN2231T1 MUN2232T1 MUN2233T1 MUN2234T1 MUN2236T1 MUN2237T1 MUN2240T1 MUN2241T1	h_{FE}	35 60 80 80 160 160 3.0 8.0 15 80 80 80 80 160 160	60 100 140 140 350 350 5.0 15 30 200 150 150 140 350 350	– – – – – – – – – – – – – – –	
Collector-Emitter Saturation Voltage ($I_C = 10\text{ mA}$, $I_B = 0.3\text{ mA}$) ($I_C = 10\text{ mA}$, $I_B = 5\text{ mA}$) MUN2230T1/MUN2231T1 ($I_C = 10\text{ mA}$, $I_B = 1\text{ mA}$) MUN2215T1/MUN2216T1/ MUN2232T1/MUN2233T1/MUN2234T1		$V_{CE(sat)}$	–	–	0.25	Vdc
Output Voltage (on) ($V_{CC} = 5.0\text{ V}$, $V_B = 2.5\text{ V}$, $R_L = 1.0\text{ k}\Omega$)	MUN2211T1 MUN2212T1 MUN2214T1 MUN2215T1 MUN2216T1 MUN2230T1 MUN2231T1 MUN2232T1 MUN2233T1 MUN2234T1	V_{OL}	– – – – – – – – – –	– – – – – – – – – –	0.2 0.2 0.2 0.2 0.2 0.2 0.2 0.2 0.2 0.2	Vdc
($V_{CC} = 5.0\text{ V}$, $V_B = 3.5\text{ V}$, $R_L = 1.0\text{ k}\Omega$)	MUN2213T1 MUN2240T1		– –	– –	0.2 0.2	
($V_{CC} = 5.0\text{ V}$, $V_B = 5.5\text{ V}$, $R_L = 1.0\text{ k}\Omega$)	MUN2236T1		–	–	0.2	
($V_{CC} = 5.0\text{ V}$, $V_B = 4.0\text{ V}$, $R_L = 1.0\text{ k}\Omega$)	MUN2237T1		–	–	0.2	
($V_{CC} = 5.0\text{ V}$, $V_B = 5.0\text{ V}$, $R_L = 1.0\text{ k}\Omega$)	MUN2241T1		–	–	0.2	

4. Pulse Test: Pulse Width < 300 μs , Duty Cycle < 2.0%

MUN2211T1 Series

ELECTRICAL CHARACTERISTICS ($T_A = 25^\circ\text{C}$ unless otherwise noted) (Continued)

Characteristic	Symbol	Min	Typ	Max	Unit
ON CHARACTERISTICS (Note 5) (Continued)					
Output Voltage (off) ($V_{CC} = 5.0\text{ V}$, $V_B = 0.5\text{ V}$, $R_L = 1.0\text{ k}\Omega$) ($V_{CC} = 5.0\text{ V}$, $V_B = 0.050\text{ V}$, $R_L = 1.0\text{ k}\Omega$) ($V_{CC} = 5.0\text{ V}$, $V_B = 0.25\text{ V}$, $R_L = 1.0\text{ k}\Omega$)	V_{OH}	4.9	–	–	Vdc
Input Resistor	R_1	7.0	10	13	k Ω
MUN2230T1		15.4	22	28.6	
MUN2215T1		32.9	47	61.1	
MUN2216T1		7.0	10	13	
MUN2233T1		7.0	10	13	
MUN2240T1		3.3	4.7	6.1	
MUN2230T1		0.7	1.0	1.3	
MUN2231T1		1.5	2.2	2.9	
MUN2232T1		3.3	4.7	6.1	
MUN2233T1		3.3	4.7	6.1	
MUN2234T1		15.4	22	28.6	
MUN2235T1		70	100	130	
MUN2236T1		32.9	47	61.1	
MUN2237T1		70	100	130	
MUN2240T1		32.9	47	61.1	
MUN2241T1		70	100	100	
Resistor Ratio	R_1/R_2	0.8	1.0	1.2	
MUN2211T1/MUN2212T1/MUN2213T1/ MUN2236T1		0.17	0.21	0.25	
MUN2214T1		–	–	–	
MUN2215T1/MUN2216T1/MUN2240T1/ MUN2241T1		0.8	1.0	1.2	
MUN2230T1/MUN2231T1/MUN2232T1		0.055	0.1	0.185	
MUN2233T1		0.38	0.47	0.56	
MUN2234T1		1.7	2.1	2.6	
MUN2237T1					

5. Pulse Test: Pulse Width < 300 μs , Duty Cycle < 2.0%

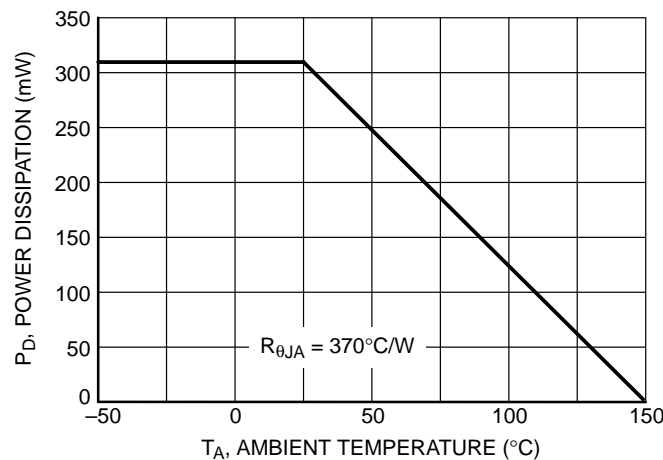

Figure 1. Derating Curve

MUN2211T1 Series

TYPICAL ELECTRICAL CHARACTERISTICS – MUN2211T1

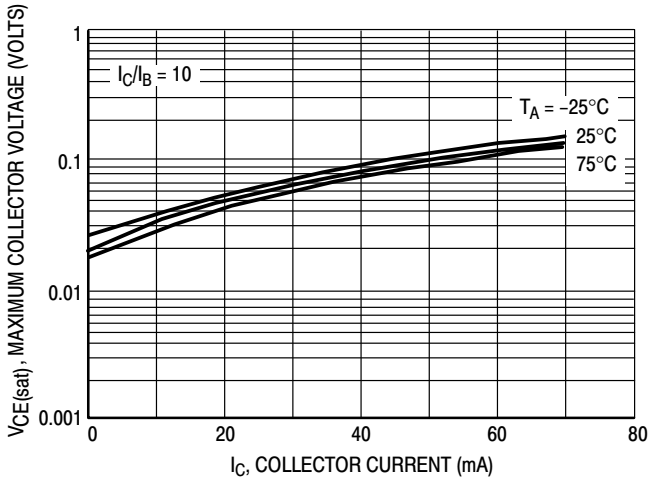

Figure 2. $V_{CE(sat)}$ versus I_C

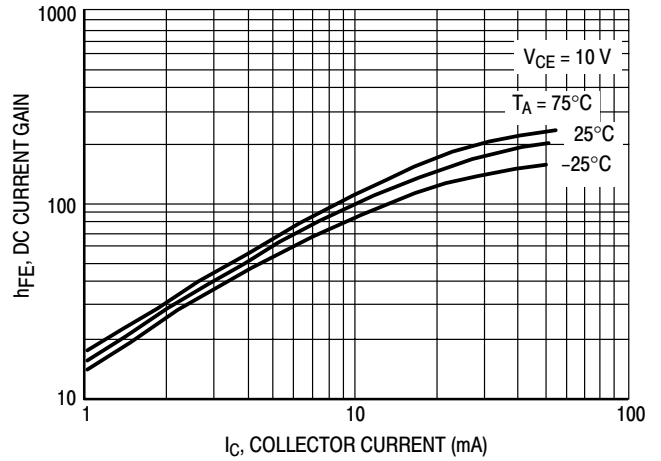

Figure 3. DC Current Gain

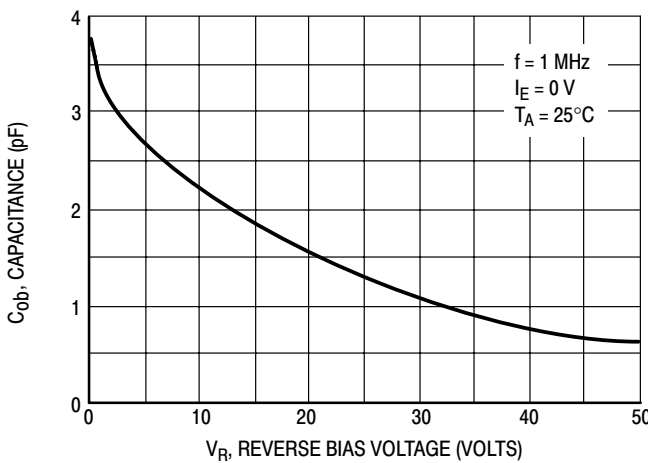

Figure 4. Output Capacitance

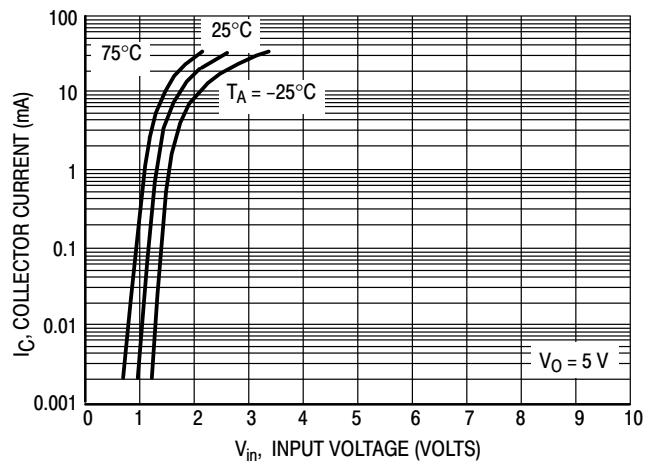

Figure 5. Output Current versus Input Voltage

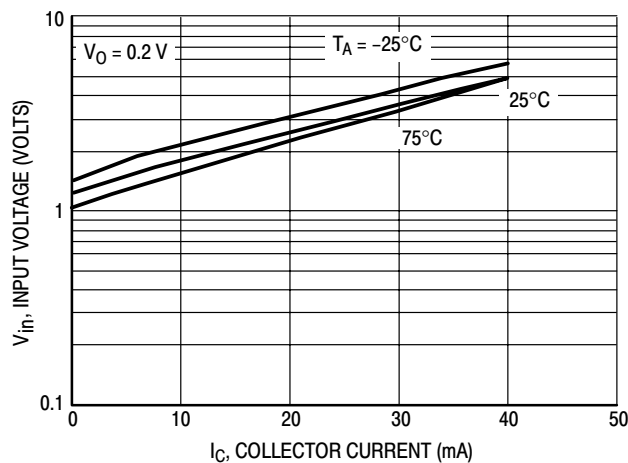

Figure 6. Input Voltage versus Output Current

MUN2211T1 Series

TYPICAL ELECTRICAL CHARACTERISTICS – MUN2212T1

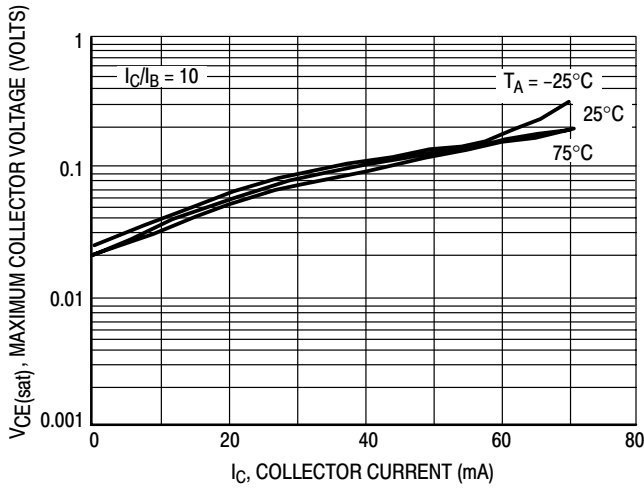

Figure 7. $V_{CE(sat)}$ versus I_C

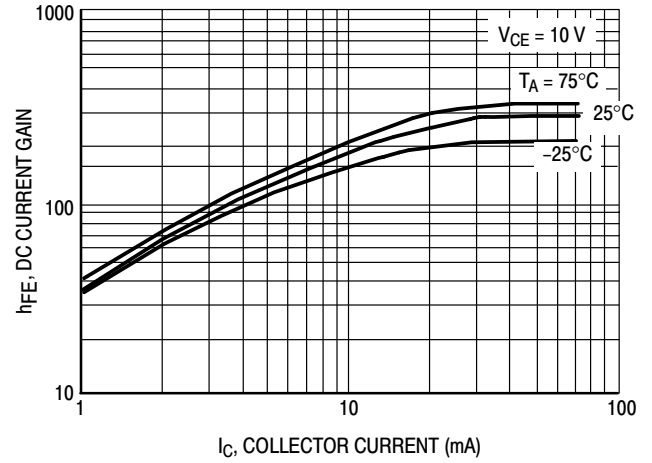

Figure 8. DC Current Gain

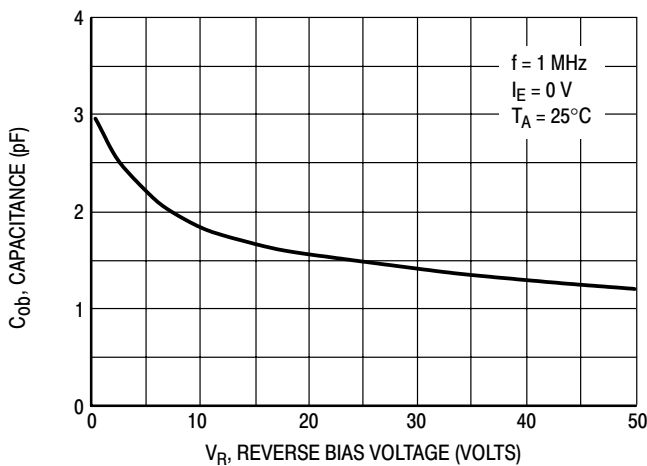

Figure 9. Output Capacitance

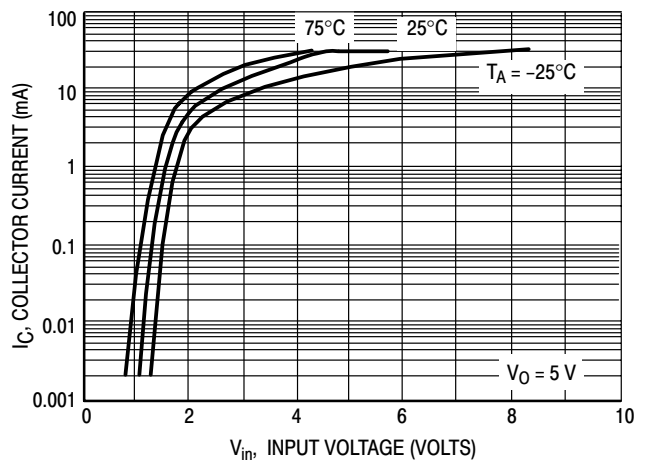

Figure 10. Output Current versus Input Voltage

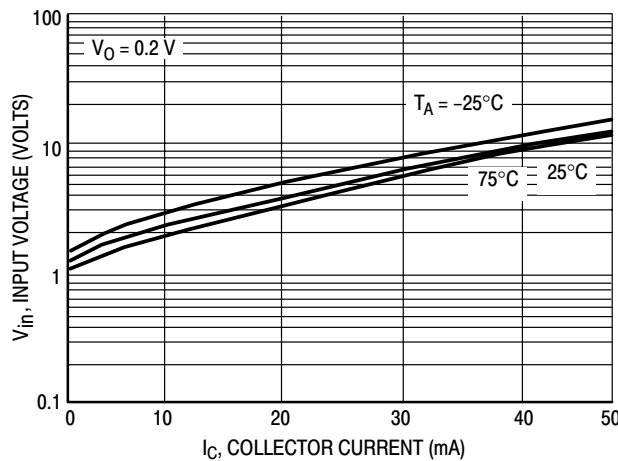

Figure 11. Input Voltage versus Output Current

MUN2211T1 Series

TYPICAL ELECTRICAL CHARACTERISTICS – MUN2213T1

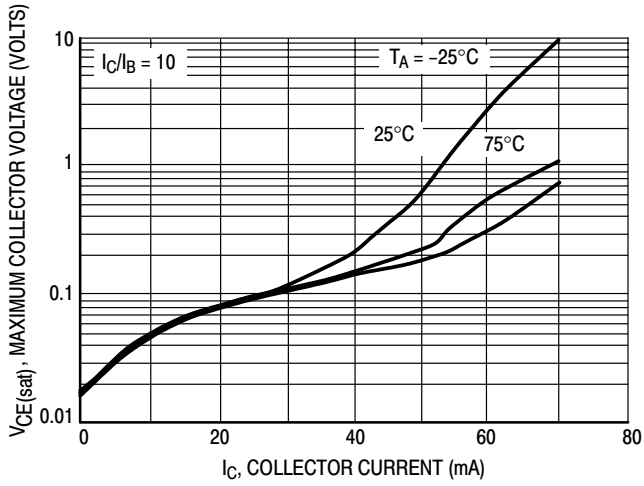

Figure 12. $V_{CE(sat)}$ versus I_C

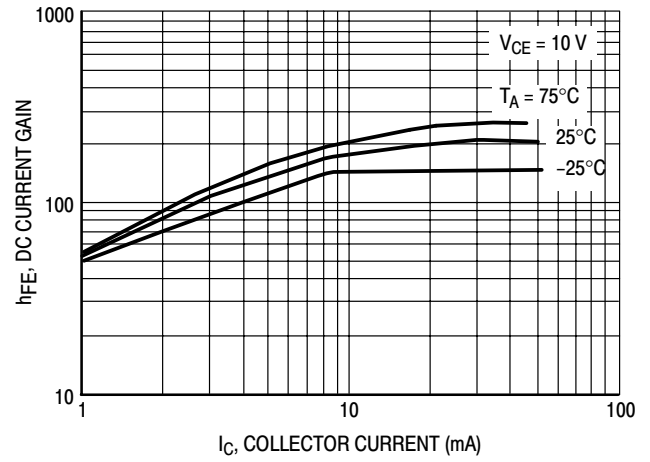

Figure 13. DC Current Gain

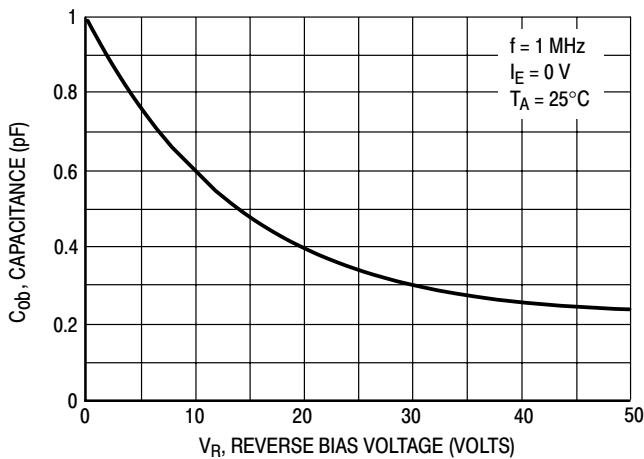

Figure 14. Output Capacitance

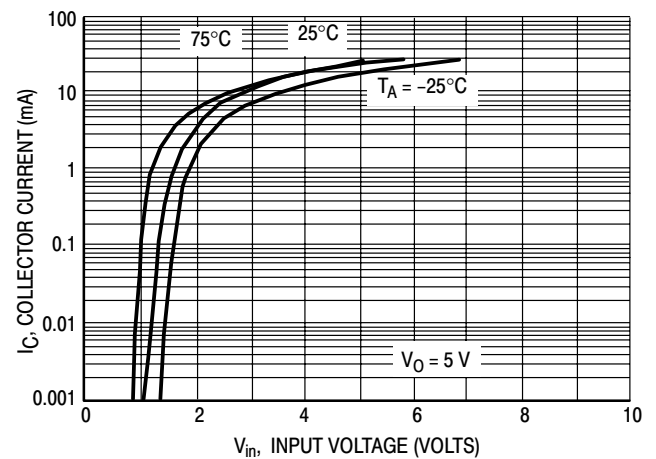

Figure 15. Output Current versus Input Voltage

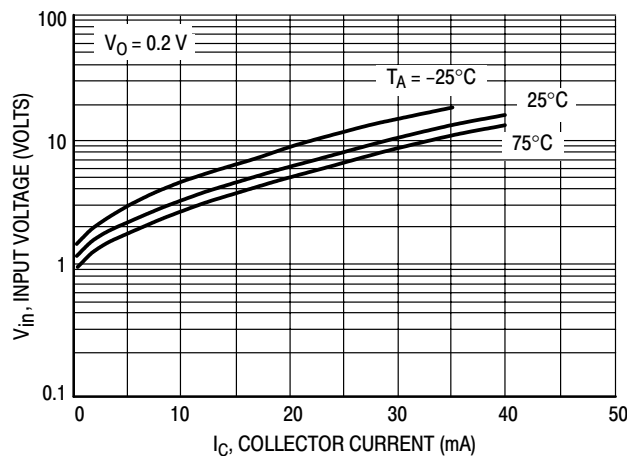

Figure 16. Input Voltage versus Output Current

MUN2211T1 Series

TYPICAL ELECTRICAL CHARACTERISTICS – MUN2214T1

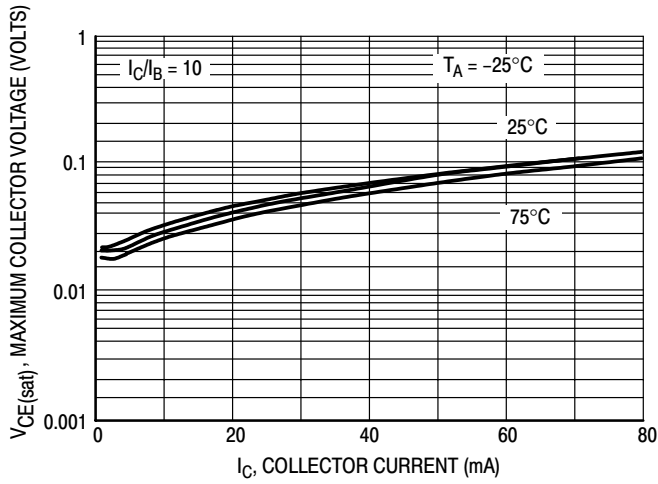

Figure 17. $V_{CE(sat)}$ versus I_C

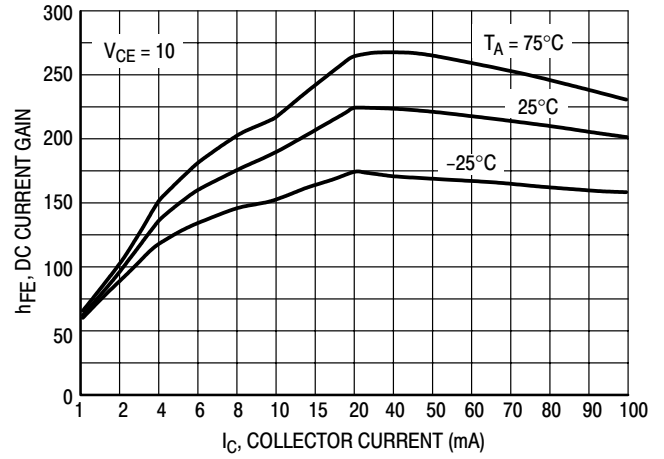

Figure 18. DC Current Gain

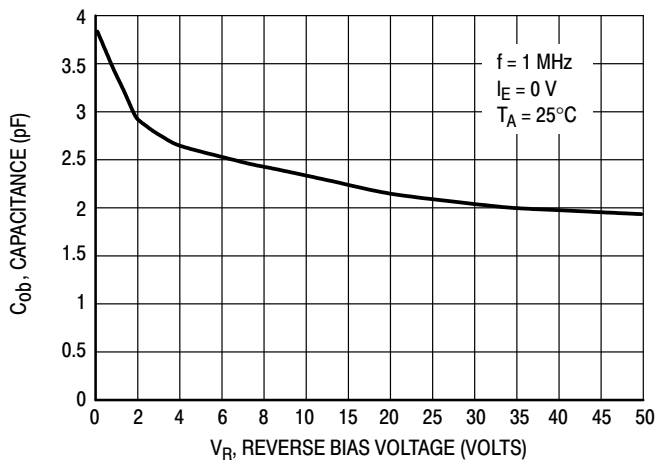

Figure 19. Output Capacitance

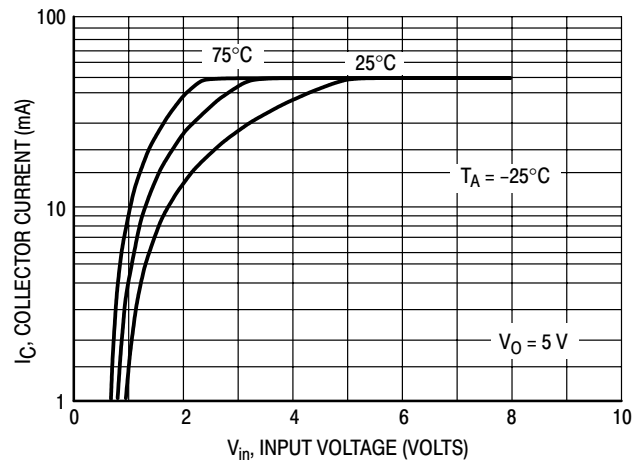

Figure 20. Output Current versus Input Voltage

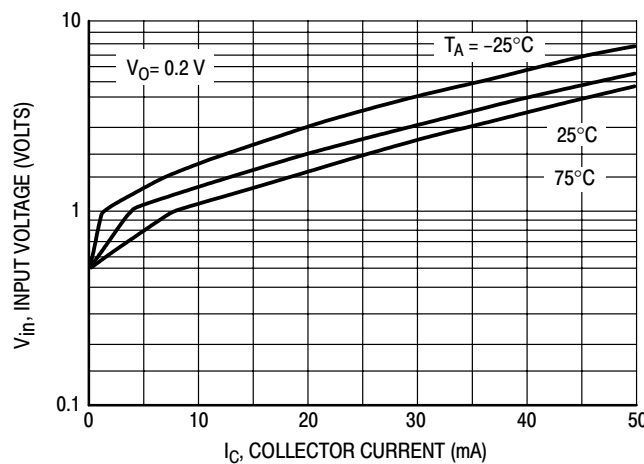

Figure 21. Input Voltage versus Output Current

MUN2211T1 Series

TYPICAL ELECTRICAL CHARACTERISTICS – MUN2236T1

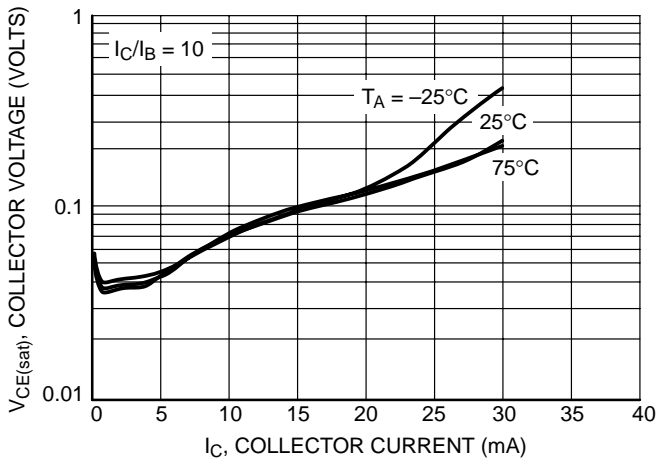

Figure 22. $V_{CE(sat)}$ versus I_C

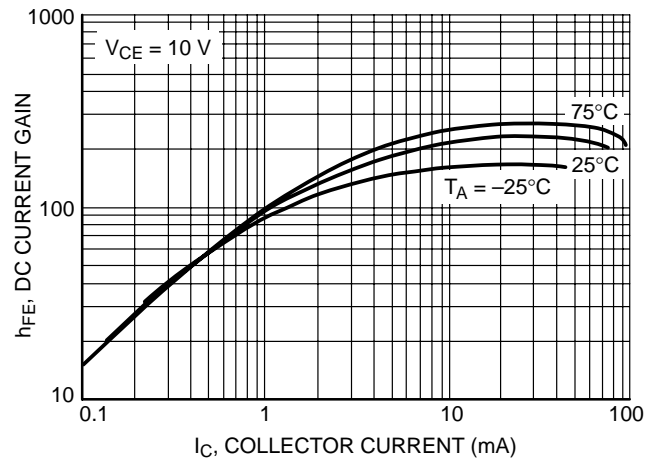

Figure 23. DC Current Gain

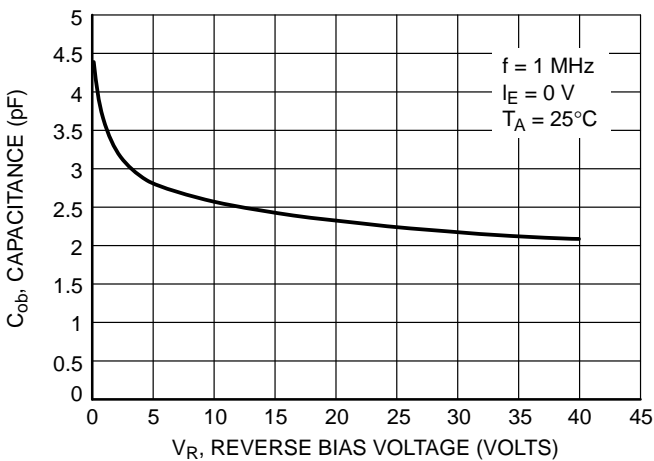

Figure 24. Output Capacitance

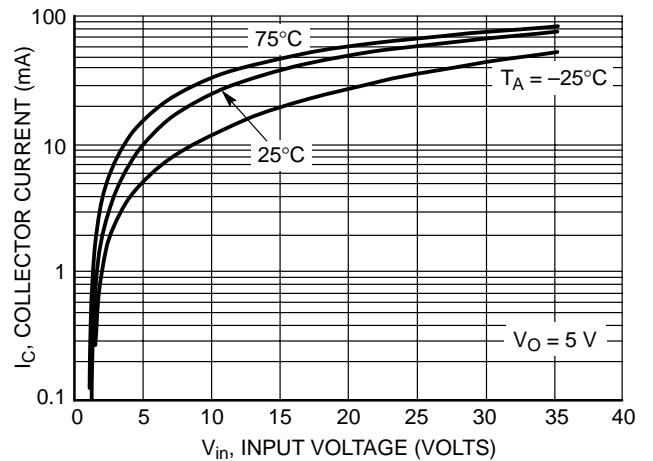

Figure 25. Output Current versus Input Voltage

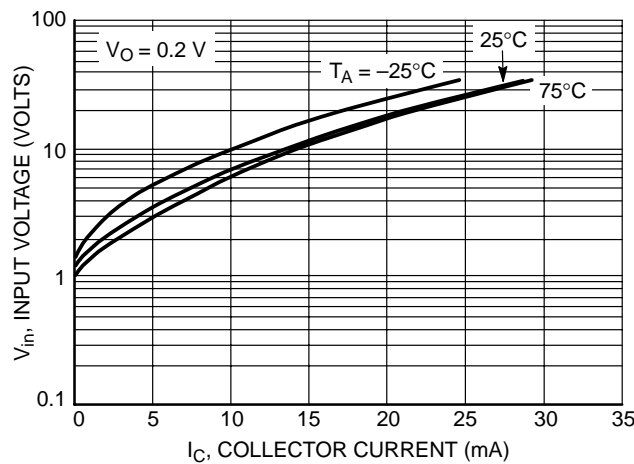

Figure 26. Input Voltage versus Output Current

MUN2211T1 Series

TYPICAL ELECTRICAL CHARACTERISTICS – MUN2237T1

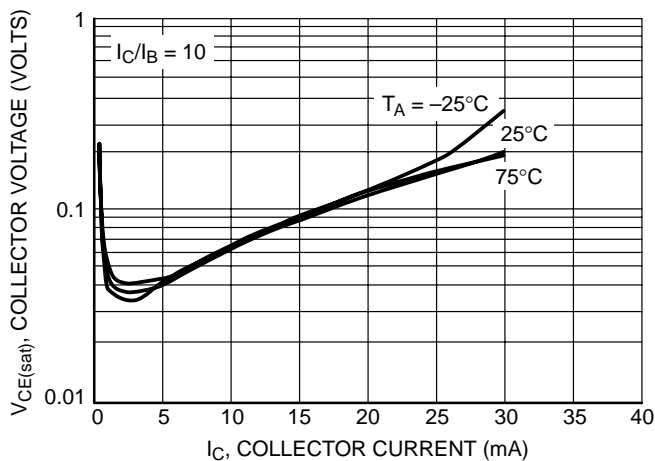

Figure 27. $V_{CE(sat)}$ versus I_C

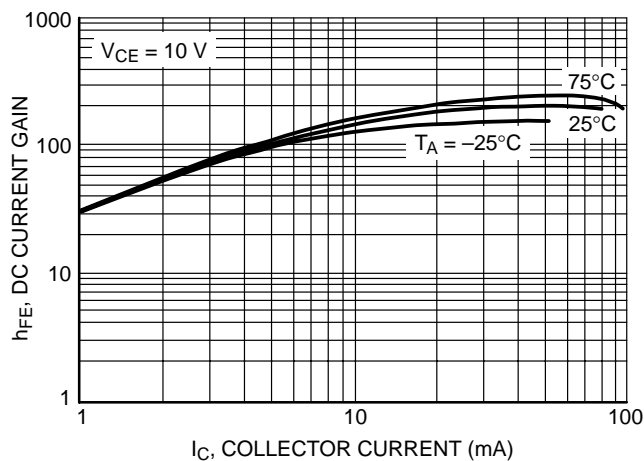

Figure 28. DC Current Gain

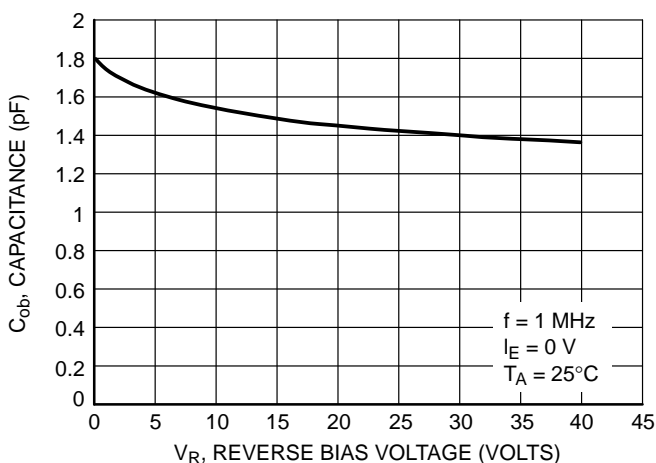

Figure 29. Output Capacitance

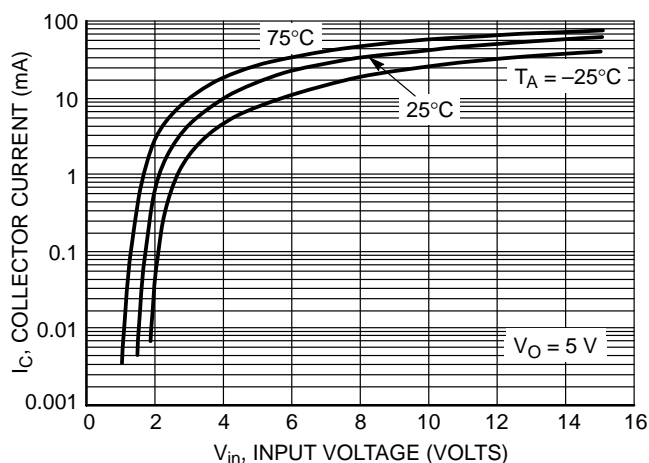

Figure 30. Output Current versus Input Voltage

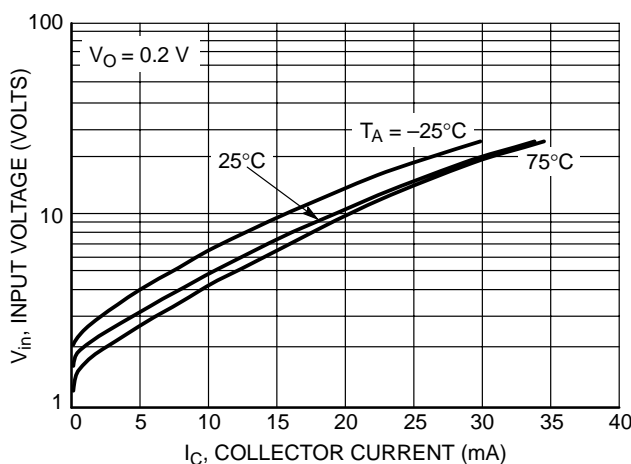

Figure 31. Input Voltage versus Output Current

MUN2211T1 Series

TYPICAL APPLICATIONS FOR NPN BRTs

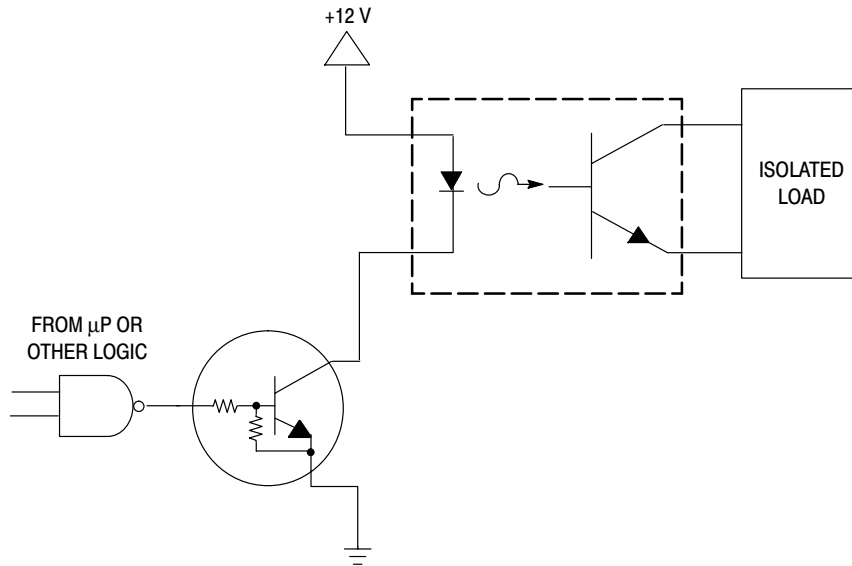

Figure 32. Level Shifter: Connects 12 or 24 Volt Circuits to Logic

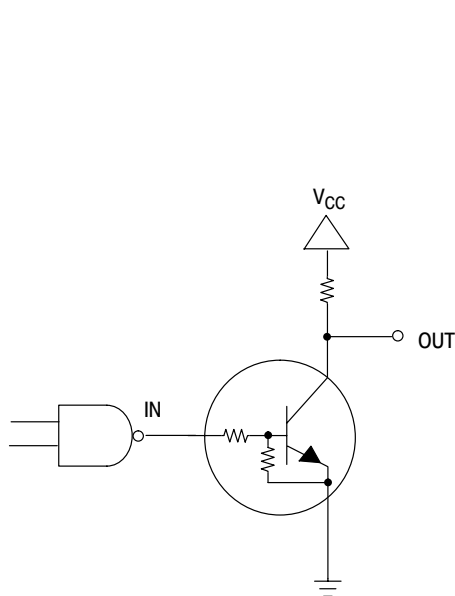

Figure 33. Open Collector Inverter: Inverts the Input Signal

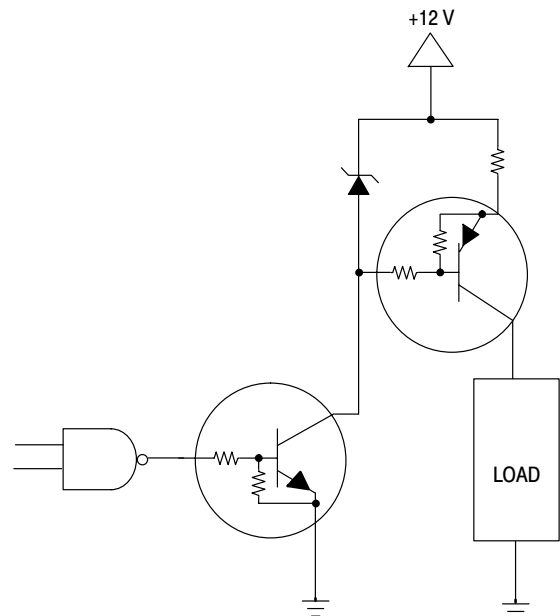

Figure 34. Inexpensive, Unregulated Current Source