

## Q-band VCO based on Ku-band Oscillator and Q-band Multiplier

### GaAs Monolithic Microwave IC

#### Description

The CHV2242a is a monolithic multifunction for frequency generation. It integrates a Ku-band oscillator with frequency control (VCO), a Q-band frequency multiplier and buffer amplifiers. For performance optimisation, two external ports (ERC1 and ERC2) allow a passive resonator coupling to the oscillator (at one third of output frequency). On chip Schottky diode, based on a P-HEMT, is used as varactor. All the active devices are internally self biased.

The circuit is manufactured with the P-HEMT process : 0.25µm gate length, via holes through the substrate, air bridges and electron beam gate lithography.

It is available in chip form.

#### Main Features

- Ku-band VCO + Q-band multiplier
- On chip varactor
- External resonator for centre frequency control and phase noise optimisation
- Low phase noise
- Auxiliary output at VCO frequency
- High temperature range
- On-chip self biasing
- Automatic assembly oriented
- Chip size 2.41 x 1.18 x 0.1 mm

#### Main Characteristics

Tamb = +25°C

Symbol	Parameter	Min	Typ	Max	Unit
F_out	Output centre frequency	38	38.25	38.5	GHz
F_vco	Oscillator frequency	F_out/3			
F_tune	Output frequency tuning range	150	200		MHz
Pout	Output power	5	7		dBm

ESD Protections : Electrostatic discharge sensitive device observe handling precautions !

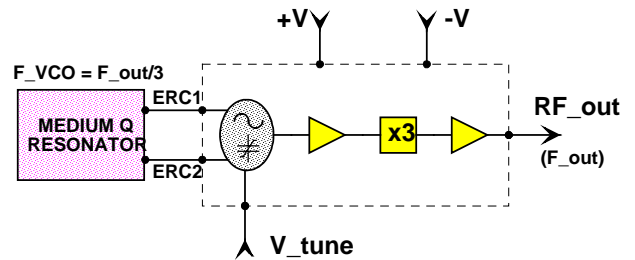

**Multifunction block diagram**

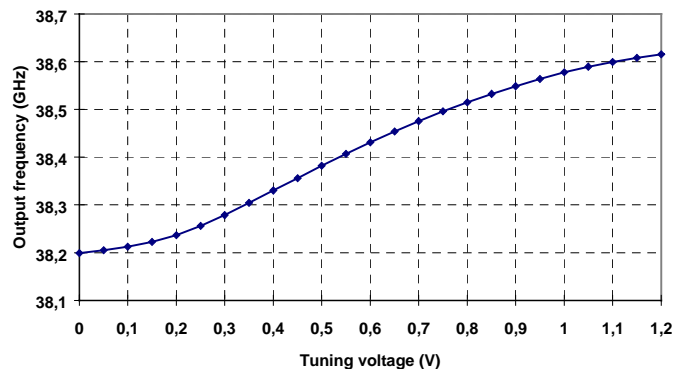

**Typical tuning characteristic**  
(coupled to a micro-strip filter)

## Electrical Characteristics

Full temperature range, used according to section "Typical assembly and bias configuration"

Symbol	Parameter	Min	Typ	Max	Unit
F_out	Output centre frequency	38	38.25	38.5	GHz
F_vco	VCO frequency (1)	F_out/3			
F_tune	Frequency tuning range (at F_out) (2)	150	200		MHz
P_out	Output power	5	7		dBm
F_slope	Frequency tuning slope (2)		500		MHz/V
V_tune	Control voltage range		0.2 – 0.8	0 – 1.5	V
Pushing	Frequency pushing vs positive supply voltage		60		MHz/v
PN	Phase noise (given at F_out) (2) @ 10kHz @ 100kHz @ 1MHz		-48 -75 -100	-43 -70 -95	dBc/Hz
+V	Positive supply voltage	4.4	4.5	4.6	V
+I	Positive supply current		110	160	mA
-V	Negative supply voltage	-4.6	-4.5	-4.4	V
-I	Negative supply current		5	8	mA
Top	Operating temperature range	-40		100	°C

(1) The centre frequency is given by the external passive resonator

(2) This characteristic depends on the resonator Q, the given performance has been obtained by using a micro-strip filter used as resonator (see section "Proposed External Medium Q Resonator")

## Absolute Maximum Ratings (1)

Symbol	Parameter	Values	Unit
V_tune	Tuning voltage	2.5	V
+V	Positive supply voltage	5	V
-V	Negative supply voltage	-5	V
+I	Positive supply current	250	mA
-I	Negative supply current	15	mA
Tstg	Storage temperature range	-55 to +155	°C

(1) Operation of this device above any of these parameters may cause permanent damage.

## Chip Mechanical Data and Pin References

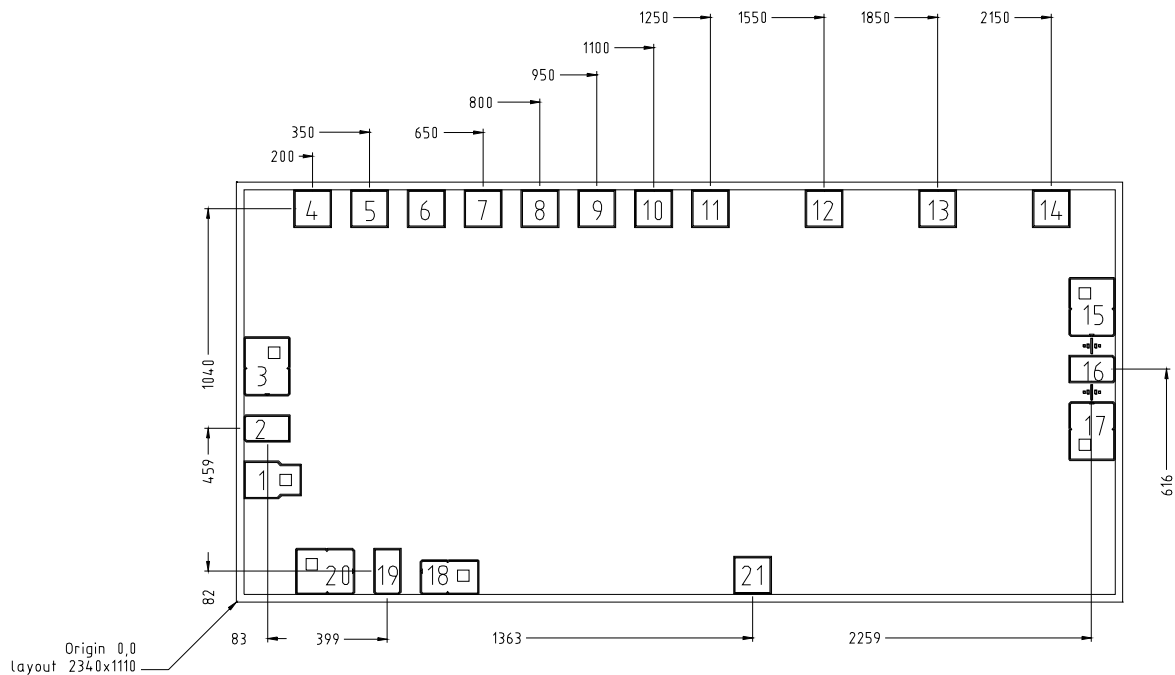
Unit =  $\mu\text{m}$ 

External chip size = 2410 x 1180 +/- 35

Chip thickness = 100 +/- 10

HF Pads (2, 16, 19) = 68 x 118

DC/IF Pads = 100 x 100

Pin number	Pin name	Description
<b>1,3,5,15,17,18,20</b>		Ground : should not be bonded. If required, please ask for more information.
<b>2</b>	<b>ERC1</b>	External Resonator Coupling Port 1
<b>4</b>	<b>V-tune</b>	Tuning voltage input port
<b>5,7,9,10,14</b>		NC
<b>6</b>		GND (optional)
<b>8,12</b>	<b>-V</b>	Negative supply voltage
<b>11,13</b>	<b>+V</b>	Positive supply voltage
<b>16</b>	<b>RF_out</b>	RF output at 38GHz
<b>19</b>	<b>ERC2</b>	External Resonator Coupling Port 2
<b>21</b>	<b>AUX</b>	Auxiliary RF output at 12.7GHz (RF_out / 3) (optional)

Typical Assembly and Bias Configuration

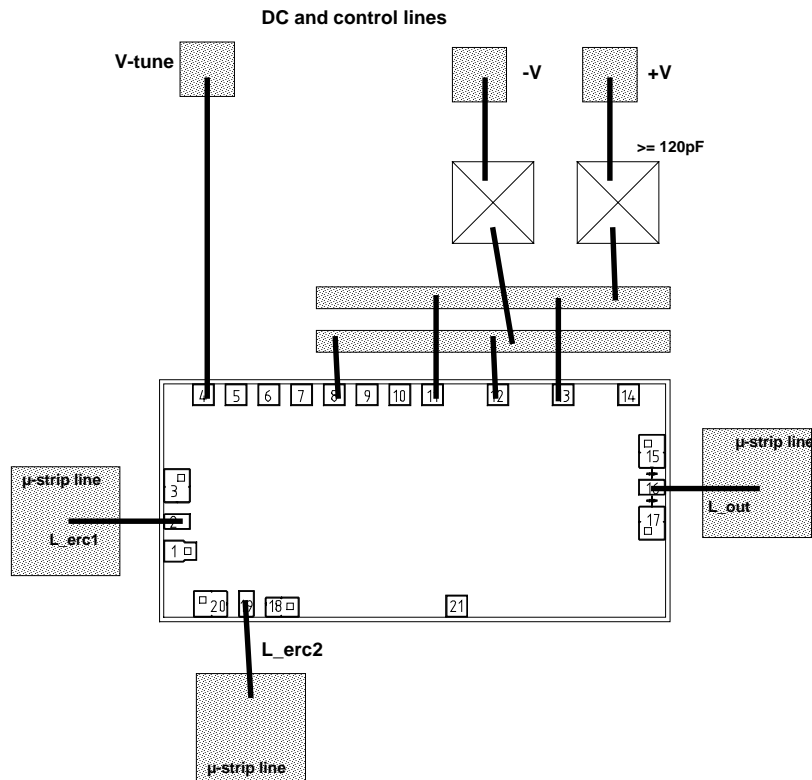

This drawing shows an example of assembly and bias configuration. All the transistors are internally self biased. The positive and negative voltages can be respectively connected together (see drawing) according to the recommended values given in the electrical characteristics table. **Due to the high value of frequency sensitivity versus tuning voltage (around 500MHz/V), the signal applied to V\_tune port must have very low level of noise.**

For the RF pads the equivalent wire bonding inductance (diameter=25μm) has to be according to the following recommendation.

Port	Equivalent inductance (nH)	Approximated wire length (mm)
ERC1 (2)	L_erc1 = 0.4	0.5
ERC2 (19)	L_erc2 = 0.4	0.5
RF_out (16)	L_out = 0.28	0.35

For a micro-strip configuration a hole in the substrate is recommended for chip assembly.

## Proposed External Medium Q Resonator

This resonator can be used for 77GHz FMCW-based radar applications.

The chip has been especially designed to be coupled to a medium Q resonator printed on temperature compensated soft substrate. The resonance is given by three half wave coupled lines. The length of the coupler (L) gives the centre frequency and the space between the coupled lines (s) gives the bandwidth. For easy connection and phase considerations half wave lines are at the input and output of the filter. All the recommended dimensions are given in the following drawing.

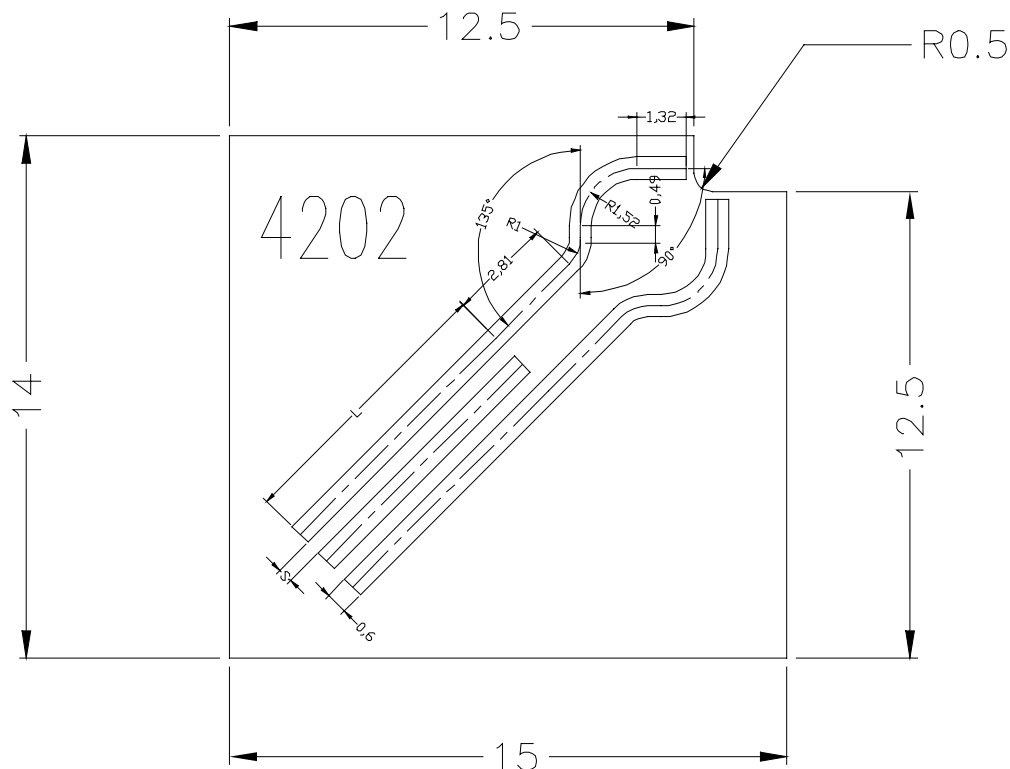

The main substrate characteristics are the following (ROGERS R03003)

Dielectric constant	Thickness	Dissipation factor (10GHz)	Thermal coefficient
3	250 $\mu$ m	0.0013	13 ppm/ $^{\circ}$ C

The typical resonator length (L) is 7.35mm for a coupling value (s) of 0.4mm and for a frequency of 38.25GHz. However this L value should have to be adjusted depending on the final chip environment.

Other possibility is ARLON/CLTE substrate. (L is 7.27mm for s=0.4mm)

Proposed External Medium Q Resonator

The following information is about the S parameter of the resonator (plot for S21 and table for the four parameters). These values don't include the wire bonding equivalent inductance L\_erc1 and L\_erc2 given in section "Typical Assembly and Bias Configuration".

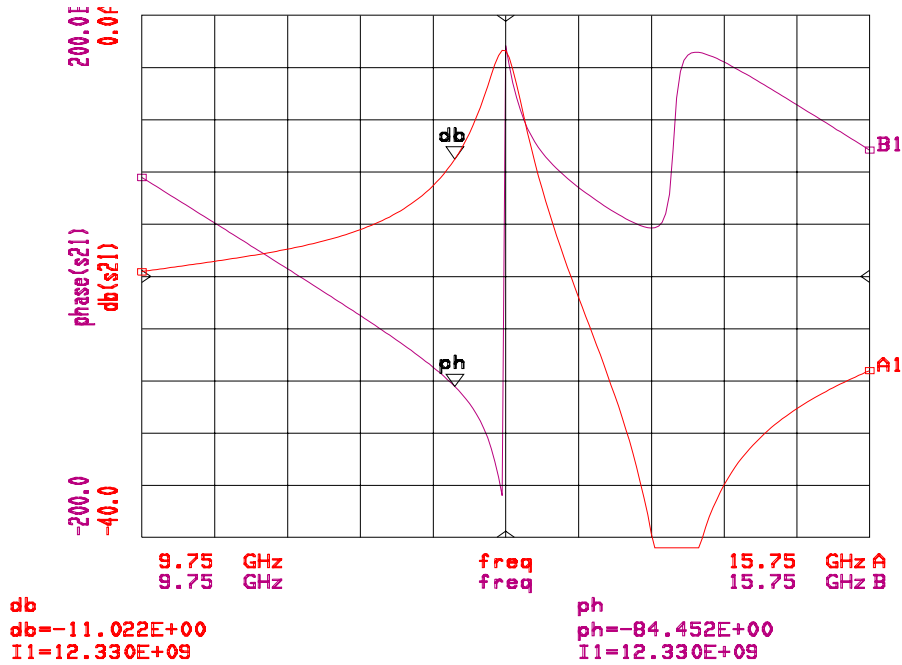

S21 of the proposed external resonator

freq	dB(S11)	phase(S11)	dB(S21)	phase(S21)	dB(S12)	phase(S12)	dB(S22)	phase(S22)
9.750E+09	-0.269	165.984	-19.639	75.748	-19.639	75.748	-0.269	165.984
10.05E+09	-0.282	148.566	-19.246	58.344	-19.246	58.344	-0.282	148.566
10.35E+09	-0.294	131.116	-18.849	40.900	-18.849	40.900	-0.294	131.116
10.65E+09	-0.306	113.629	-18.421	23.404	-18.421	23.404	-0.306	113.629
10.95E+09	-0.320	96.082	-17.921	5.819	-17.921	5.819	-0.320	96.082
11.25E+09	-0.337	78.416	-17.290	-11.932	-17.290	-11.932	-0.337	78.416
11.55E+09	-0.364	60.508	-16.428	-30.016	-16.428	-30.016	-0.364	60.508
11.85E+09	-0.415	42.062	-15.152	-48.824	-15.152	-48.824	-0.415	42.062
12.15E+09	-0.543	22.219	-13.061	-69.511	-13.061	-69.511	-0.543	22.219
12.45E+09	-1.135	-2.751	-9.044	-97.347	-9.044	-97.347	-1.135	-2.751
12.75E+09	-12.026	15.650	-2.717	176.749	-2.717	176.749	-12.026	15.650
13.05E+09	-0.736	-2.650	-13.295	95.005	-13.295	95.005	-0.736	-2.650
13.35E+09	-0.357	-27.461	-21.583	68.175	-21.583	68.175	-0.357	-27.461
13.65E+09	-0.294	-47.296	-29.127	49.027	-29.127	49.027	-0.294	-47.296
13.95E+09	-0.278	-65.784	-39.725	36.983	-39.725	36.983	-0.278	-65.784
14.25E+09	-0.275	-83.768	-45.375	169.387	-45.375	169.387	-0.275	-83.768
14.55E+09	-0.277	-101.542	-35.988	164.157	-35.988	164.157	-0.277	-101.542
14.85E+09	-0.282	-119.232	-32.348	148.414	-32.348	148.414	-0.282	-119.232
15.15E+09	-0.289	-136.894	-30.136	131.474	-30.136	131.474	-0.289	-136.894
15.45E+09	-0.297	-154.550	-28.526	114.171	-28.526	114.171	-0.297	-154.550
15.75E+09	-0.305	-172.202	-27.227	96.721	-27.227	96.721	-0.305	-172.202

S parameters of the proposed external resonator

### External Resonator Coupling Information

The external resonator has to be an equivalent band-pass filter with 180° insertion phase at resonance (oscillation) frequency. However, this filter must be compatible to the loop parameters of the oscillator (between ERC ports) in order to obtain the oscillation conditions and to avoid parasitic oscillations. The following information concerns the S parameters of the chip (plots for S21 and tables for the four parameters), reference ports are ERC1 and ERC2. These values don't include the wire bonding equivalent inductance L\_erc1 and L\_erc2 given in section "Typical Assembly and Bias Configuration". For more detail and for a wider band analysis a complete S parameter file is available on request.

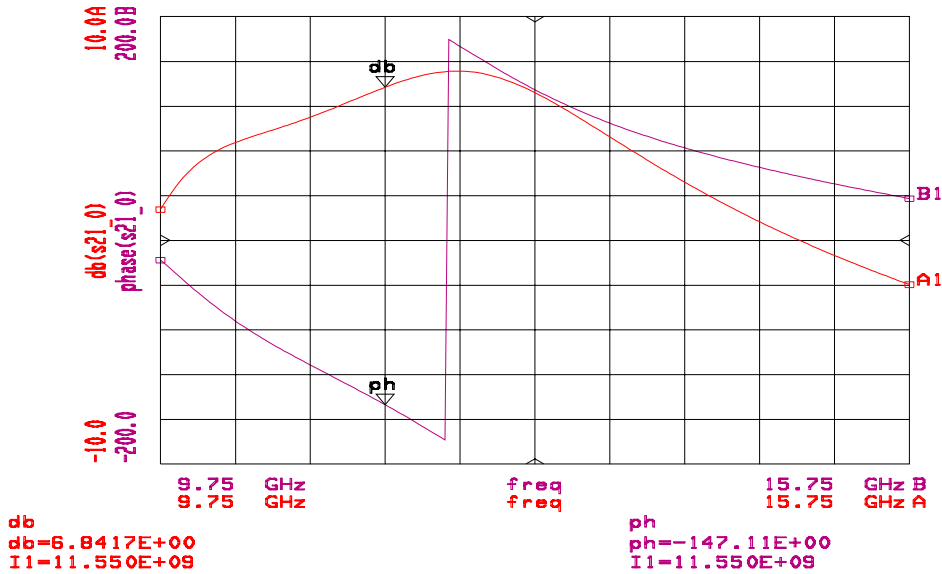

MMIC S21 for V<sub>tune</sub>=0V (between ERC1 and ERC2)

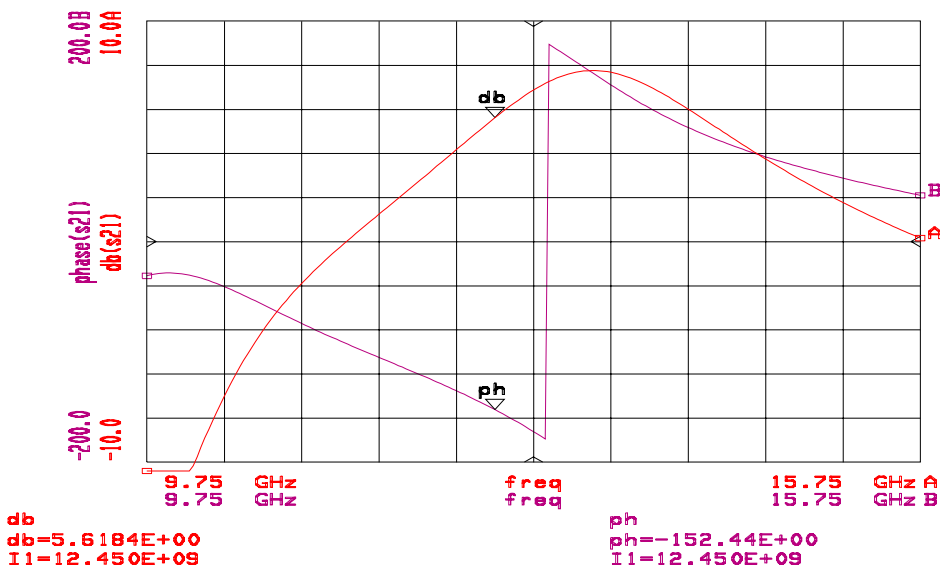

MMIC S21 for V<sub>tune</sub>=2V (between ERC1 and ERC2)

Vtune=0V								
freq	dB(S11_0)	phase(S11_0)	dB(S21_0)	phase(S21_0)	dB(S12_0)	phase(S12_0)	dB(S22_0)	phase(S22_0)
15.75E+09	-0.909	-37.688	-1.979	37.302	-28.895	-28.074	-9.310	-32.526
15.45E+09	-1.001	-33.724	-1.351	43.690	-28.379	-22.432	-9.248	-31.424
15.15E+09	-1.119	-29.336	-0.678	50.407	-27.825	-16.491	-9.182	-30.190
14.85E+09	-1.272	-24.403	0.046	57.529	-27.223	-10.173	-9.117	-28.756
14.55E+09	-1.475	-18.758	0.829	65.163	-26.567	-3.373	-9.063	-27.039
14.25E+09	-1.753	-12.159	1.678	73.457	-25.849	4.057	-9.034	-24.946
13.95E+09	-2.143	-4.251	2.598	82.615	-25.066	12.322	-9.056	-22.372
13.65E+09	-2.711	5.511	3.586	92.919	-24.220	21.703	-9.172	-19.216
13.35E+09	-3.569	18.006	4.623	104.740	-23.329	32.570	-9.455	-15.430
13.05E+09	-4.910	34.787	5.662	118.520	-22.442	45.365	-10.026	-11.185
12.75E+09	-7.017	59.041	6.601	134.644	-21.659	60.473	-11.070	-7.327
12.45E+09	-9.880	98.309	7.287	153.129	-21.135	77.909	-12.771	-6.466
12.15E+09	-10.946	158.475	7.560	173.230	-21.028	96.929	-14.862	-14.170
11.85E+09	-8.493	-150.360	7.372	-166.453	-21.387	116.129	-15.697	-32.447
11.55E+09	-6.162	-118.188	6.842	-147.118	-22.094	134.312	-14.447	-47.358
11.25E+09	-4.860	-95.162	6.163	-129.026	-22.954	151.215	-12.796	-52.796
10.95E+09	-4.432	-76.155	5.501	-111.513	-23.803	167.500	-11.543	-53.448
10.65E+09	-4.911	-58.364	4.928	-93.235	-24.567	-175.491	-10.686	-52.732
10.35E+09	-6.944	-40.036	4.369	-72.271	-25.324	-155.838	-10.044	-52.316
10.05E+09	-13.611	-25.957	3.433	-46.725	-26.462	-131.649	-9.334	-52.460
9.750E+09	-15.198	-136.320	1.373	-17.655	-28.730	-103.982	-8.413	-51.044

MMIC S parameters for V\_tune=0V (between ERC1 and ERC2)

Vtune=2V								
freq	dB(S11)	phase(S11)	dB(S21)	phase(S21)	dB(S12)	phase(S12)	dB(S22)	phase(S22)
15.75E+09	-1.191	-33.887	0.161	42.000	-26.755	-23.375	-8.400	-32.211
15.45E+09	-1.376	-29.200	0.928	49.481	-26.101	-16.640	-8.253	-29.920
15.15E+09	-1.633	-23.814	1.777	57.617	-25.370	-9.280	-8.109	-27.161
14.85E+09	-2.004	-17.481	2.716	66.647	-24.553	-1.055	-7.983	-23.720
14.55E+09	-2.568	-9.839	3.749	76.922	-23.646	8.386	-7.912	-19.306
14.25E+09	-3.483	-0.363	4.865	88.954	-22.663	19.554	-7.964	-13.530
13.95E+09	-5.090	11.663	6.006	103.437	-21.658	33.144	-8.286	-5.945
13.65E+09	-8.254	26.999	7.033	121.113	-20.773	49.896	-9.174	3.632
13.35E+09	-16.350	45.833	7.678	142.165	-20.275	69.995	-11.186	13.935
13.05E+09	-18.741	-112.885	7.644	165.239	-20.460	92.084	-15.178	18.553
12.75E+09	-9.089	-92.218	6.876	-172.333	-21.385	113.496	-20.797	-7.678
12.45E+09	-5.805	-73.654	5.618	-152.441	-22.803	132.340	-18.673	-55.104
12.15E+09	-4.417	-57.195	4.167	-135.199	-24.421	148.500	-14.787	-64.472
11.85E+09	-3.965	-41.715	2.692	-119.756	-26.067	162.826	-12.469	-63.496
11.55E+09	-4.168	-25.637	1.240	-105.065	-27.696	176.365	-11.011	-60.523
11.25E+09	-5.076	-6.815	-0.239	-90.138	-29.356	-169.897	-10.013	-57.232
10.95E+09	-7.038	18.650	-1.898	-74.192	-31.202	-155.179	-9.280	-53.991
10.65E+09	-10.467	61.585	-4.032	-57.152	-33.528	-139.408	-8.715	-50.811
10.35E+09	-11.475	137.785	-7.021	-40.799	-36.714	-124.366	-8.273	-47.615
10.05E+09	-7.363	-166.280	-11.054	-29.774	-40.949	-114.698	-7.943	-44.404
9.750E+09	-4.405	-136.055	-15.622	-30.964	-45.725	-117.291	-7.713	-41.264

MMIC S parameters for V\_tune=2V (between ERC1 and ERC2)

## Ordering Information

Chip form : CHV2242a-99F/00

Information furnished is believed to be accurate and reliable. However **united monolithic semiconductors S.A.S.** assumes no responsibility for the consequences of use of such information nor for any infringement of patents or other rights of third parties which may result from its use. No license is granted by implication or otherwise under any patent or patent rights of **united monolithic semiconductors S.A.S.** Specifications mentioned in this publication are subject to change without notice. This publication supersedes and replaces all information previously supplied. **United monolithic semiconductors S.A.S.** products are not authorised for use as critical components in life support devices or systems without express written approval from **united monolithic semiconductors S.A.S.**