

# 3.2Gbps Quad Adaptive Cable Equalizer with Cable Driver

## General Description

The MAX3802 has four independent adaptive cable equalizers and cable drivers on a single chip. It is designed for coaxial and twin-axial cable point-to-point scrambled-data communication applications. The driver features differential current-mode logic (CML) inputs and outputs. The equalizer includes differential CML data inputs and outputs and a TTL loss-of-signal ( $\overline{\text{LOS}}$ ) output.

The adaptive cable equalizer can equalize differential or single-ended signals at data rates up to 3.2Gbps. It automatically adjusts to attenuation caused by skin-effect losses of 30dB at 1.6GHz. The equalizer effectively extends the usable length of copper cable in high-frequency interconnect applications.

## Applications

High-Speed Links in Communications and Data Systems

Backplane and Twin-Axial Cable Interconnects

Category 5 UTP-Based Systems

Digital Video Systems

## Features

- ◆ Single 3.3V Operation
- ◆ Four Independent Equalizers and Drivers
- ◆ 725mW at 3.3V Typical Power Dissipation
- ◆ Data Rates Up to 3.2Gbps
- ◆ Equalizer Automatically Adjusts for Different Cable Lengths
- ◆ 0 to 30dB Equalization at 1.6GHz (3.2Gbps)
- ◆ Loss-of-Signal ( $\overline{\text{LOS}}$ ) Indicator
- ◆ On-Chip Input and Output Terminations
- ◆ Low External Component Count
- ◆ 0°C to +85°C Operating Temperature Range
- ◆ ESD Protection on Cable Inputs and Outputs

## Ordering Information

PART	TEMP RANGE	PIN-PACKAGE
MAX3802UGK	0°C to +85°C	68 QFN*

\*Exposed pad

Pin Configuration appears at end of data sheet.

## Typical Application Circuit

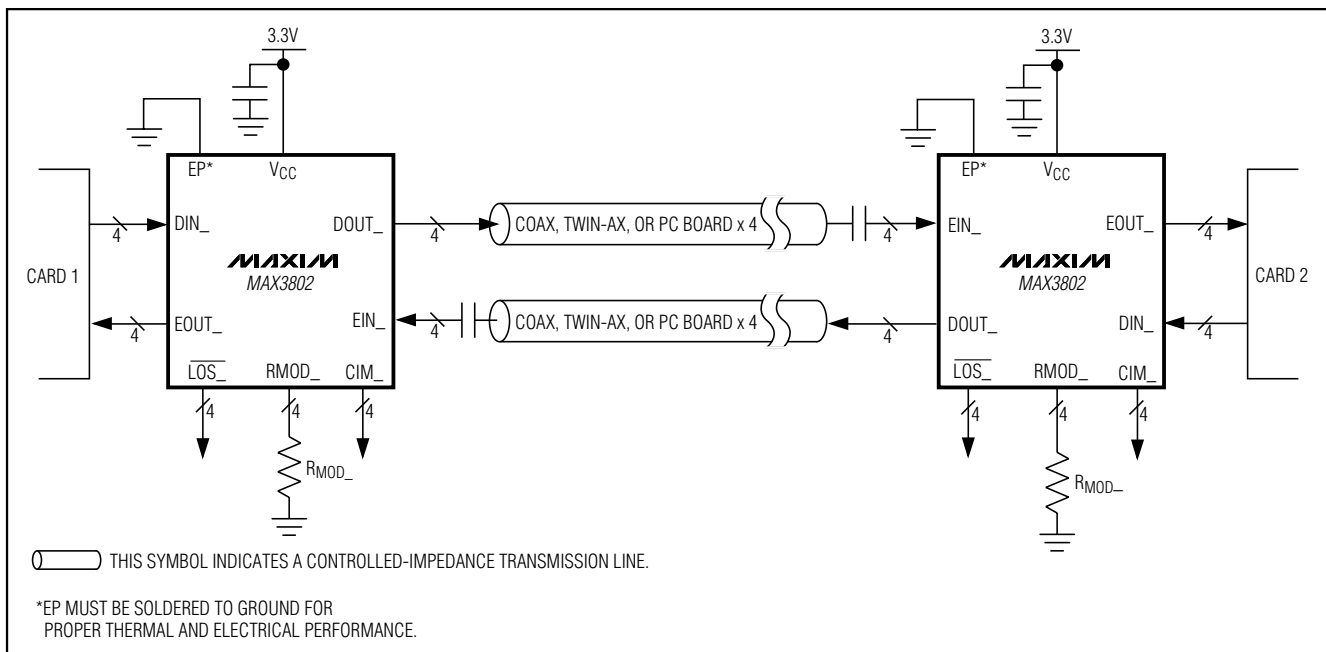

# 3.2Gbps Quad Adaptive Cable Equalizer with Cable Driver

## ABSOLUTE MAXIMUM RATINGS

Supply Voltage,  $V_{CC}$ .....-0.5V to +6.0V  
 Voltage at  $\overline{LOS}_-$ ,  $CIM_-$ , and  $RMOD_-$  .....-0.5V to ( $V_{CC} + 0.5V$ )  
 Voltage at  $EIN_+$ ,  $EIN_-$ ,  
 $DIN_+$ , and  $DIN_-$  .....( $V_{CC} - 1V$ ) to ( $V_{CC} + 0.5V$ )  
 Current Out of  $EOUT_+$ ,  $EOUT_-$ ,  
 $DOUT_+$ , and  $DOUT_-$  .....25mA

Continuous Power Dissipation ( $T_A = +85^\circ C$ )  
 68-Pin QFN (derate 44.8mW/ $^\circ C$  above  $+85^\circ C$ ) .....1.44W  
 Operating Ambient Temperature Range ..... $0^\circ C$  to  $+85^\circ C$   
 Storage Ambient Temperature Range..... $-55^\circ C$  to  $+150^\circ C$   
 Lead Temperature (soldering, 10s) ..... $+300^\circ C$

Stresses beyond those listed under "Absolute Maximum Ratings" may cause permanent damage to the device. These are stress ratings only, and functional operation of the device at these or any other conditions beyond those indicated in the operational sections of the specifications is not implied. Exposure to absolute maximum rating conditions for extended periods may affect device reliability.

## DC ELECTRICAL CHARACTERISTICS

( $V_{CC} = 3.14V$  to  $3.46V$ ,  $T_A = 0^\circ C$  to  $+85^\circ C$ . Typical values are at  $V_{CC} = 3.3V$  and  $T_A = +25^\circ C$ , unless otherwise noted.)

PARAMETER	SYMBOL	CONDITIONS	MIN	TYP	MAX	UNITS
Supply Current	$I_{CC}$	Includes external load current (Note 1)		220	345	mA
<b>CABLE DRIVER INPUT SPECIFICATIONS</b>						
Input Voltage (Single Ended)	$V_{DIN_+}$ , $V_{DIN_-}$		$V_{CC} - 0.6$		$V_{CC} + 0.2$	V
Input Voltage (Differential)	$V_{DIN_-}$		400		1100	mV <sub>P-P</sub>
Input Impedance		Single ended	40	50	60	$\Omega$
<b>CABLE DRIVER OUTPUT SPECIFICATIONS</b>						
Output Voltage (Differential)		$RMOD_- = 10k\Omega$ (Note 2)	750	825	1000	mV <sub>P-P</sub>
		$RMOD_- = 20k\Omega$ (Note 2)	400	445	550	
Output Impedance		Single ended	50	62.5	75	$\Omega$
<b>CABLE EQUALIZER INPUT SPECIFICATIONS</b>						
Minimum Cable Input (Differential)		3.2Gbps, 30dB cable loss (Note 3)			400	mV <sub>P-P</sub>
Maximum Cable Input (Differential)				600		mV <sub>P-P</sub>
Input Impedance			40	50	60	$\Omega$
<b>CABLE EQUALIZER OUTPUT SPECIFICATIONS</b>						
Output Voltage (Differential)		(Note 2)	500		1000	mV <sub>P-P</sub>
Output Impedance		Single ended	50	62.5	75	$\Omega$
Voltage at $\overline{LOS}_-$		Output high (Note 4)	2.4			V
		Output low (Note 4)			0.4	

# 3.2Gbps Quad Adaptive Cable Equalizer with Cable Driver

MAX3802

## AC ELECTRICAL CHARACTERISTICS

( $V_{CC} = 3.14V$  to  $3.46V$ ,  $T_A = 0^\circ C$  to  $+85^\circ C$ . Typical values are at  $V_{CC} = 3.3V$  and  $T_A = +25^\circ C$ , unless otherwise noted.)

PARAMETER	SYMBOL	CONDITIONS	MIN	TYP	MAX	UNITS
Maximum Input Data Rate			3.2			Gbps
<b>CABLE DRIVER SPECIFICATIONS</b>						
Random Jitter		3.2Gbps input		2.7	4	mUI <sub>RMS</sub>
Deterministic Jitter		(Notes 6, 9)		20	60	mUI <sub>P-P</sub>
Output Edge Speed		20% to 80%		60	90	ps
Input Return Loss (Differential)		≤ 2.5GHz		-20		dB
Output Return Loss (Differential)		≤ 2.5GHz		-13		dB
<b>EQUALIZER SPECIFICATIONS</b>						
Residual Jitter (Notes 7, 9)		0dB cable loss (Note 8)		0.10	0.24	UI <sub>P-P</sub>
		24dB cable loss (Note 8)		0.11	0.20	
		30dB cable loss (Note 8)		0.08	0.20	
Output Edge Speed		20% to 80%		60	90	ps
Input Return Loss (Differential)		≤ 2.5GHz		-16		dB
Output Return Loss (Differential)		≤ 2.5GHz		-14		dB
Equalizer Compensation		1.6GHz (skin-effect losses only)	30			dB
Equalizer Time Constant		(Note 10)		6		μs

**Note 1:** Equalizer total currents (equalizer with maximum equalization) and  $R_{MOD} = 10k\Omega$  (maximum driver swing).

**Note 2:** Input voltage within specification limits,  $50\Omega$  to  $V_{CC}$  at each output.

**Note 3:** Minimum cable input for  $\overline{LOS}_-$  to deassert high.

**Note 4:**  $100k\Omega$  load to ground. The minimum input signal level that turns off the  $\overline{LOS}_-$  alarm depends on the data rate and cable length.

**Note 5:** AC electrical characteristics are guaranteed by design and characterization.

**Note 6:**  $V_{DIN\_} = 400mV_{P-P}$  to  $1100mV_{P-P}$  (differential),  $10k\Omega \leq R_{MOD\_} \leq 20k\Omega$ , 3.2Gbps  $2^{13} - 1$  PRBS plus 100 consecutive ones and 100 consecutive zeros.

**Note 7:** Includes random jitter and deterministic jitter for BER of  $10^{-12}$ .

**Note 8:** Differential cable input voltage =  $400mV_{P-P}$ , 3.2Gbps  $2^{13} - 1$  PRBS plus 100 consecutive ones and 100 consecutive zeros.

**Note 9:** Isolation test: three channels driven with identical 3.2Gbps PRBS with maximum input signal to each equalizer and maximum input signal on driver. The measured channel meets the residual and random jitter specifications with an uncorrelated 3.2Gbps PRBS data at minimum input signal level on equalizer and maximum signal level on driver.

**Note 10:** Equalizer time constant measured from data on to closed-loop operation.

# 3.2Gbps Quad Adaptive Cable Equalizer with Cable Driver

## Typical Operating Characteristics

( $V_{CC} = 3.3V$ ,  $T_A = +25^\circ C$ , all jitter measurements done at 3.2Gbps, 600mV cable input with  $2^{13} - 1$  PRBS pattern with 100 consecutive ones and 100 consecutive zeros substituted. **Note:** Test pattern produces near-worst-case jitter results. Results vary with pattern, unless otherwise noted.)

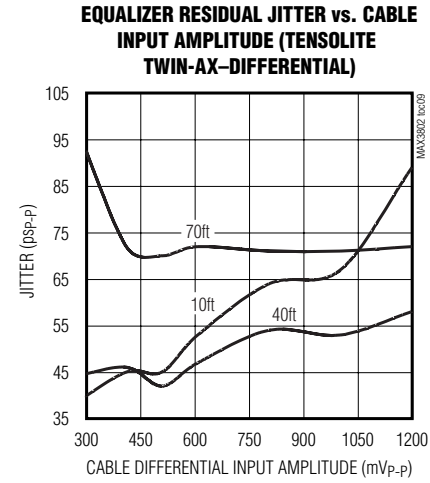
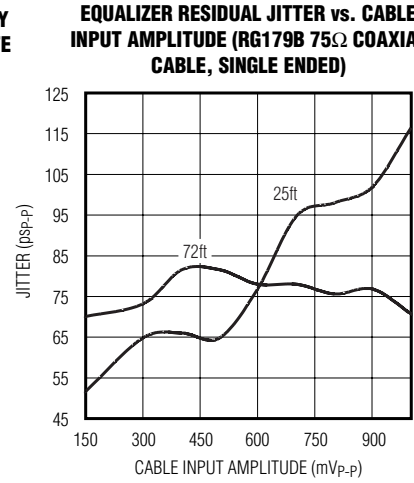
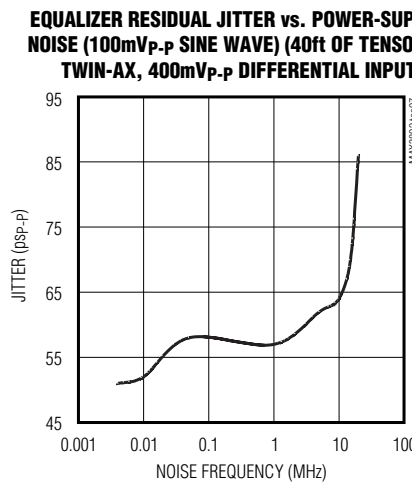
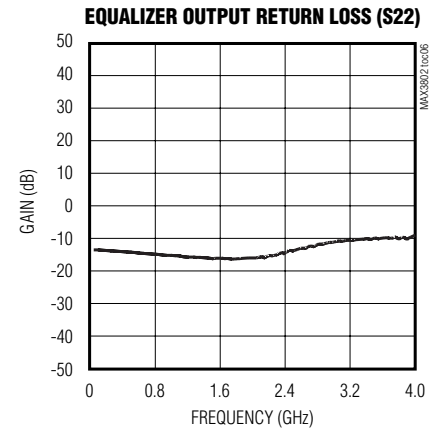
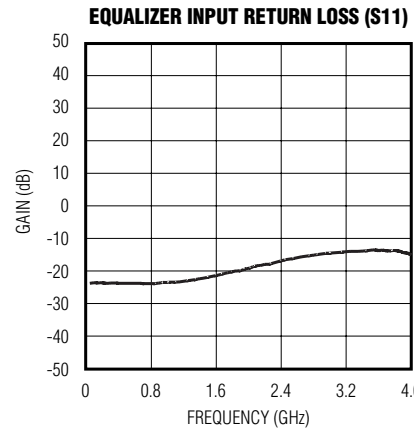
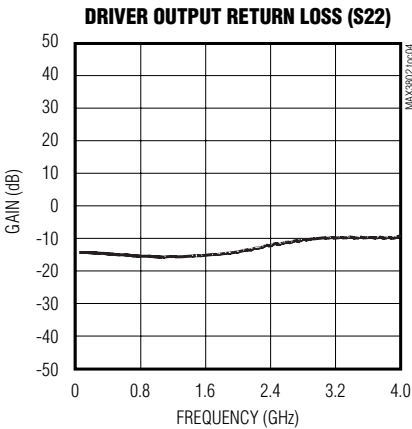
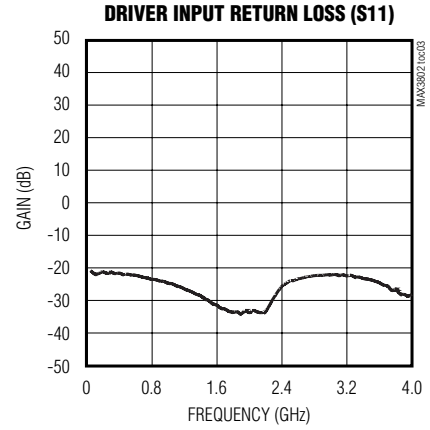
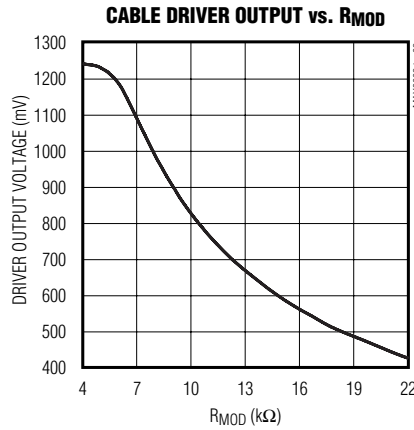
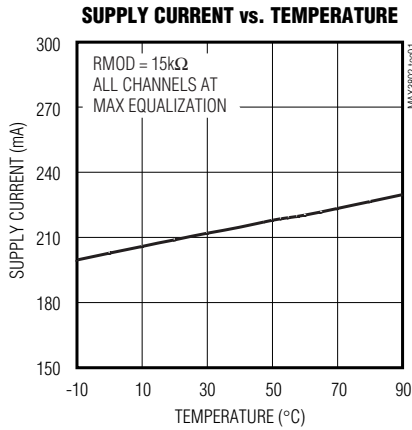

# 3.2Gbps Quad Adaptive Cable Equalizer with Cable Driver

MAX3802

## Typical Operating Characteristics (continued)

( $V_{CC} = 3.3V$ ,  $T_A = +25^\circ C$ , all jitter measurements done at 3.2Gbps, 600mV cable input with  $2^{13} - 1$  PRBS pattern with 100 consecutive ones and 100 consecutive zeros substituted. **Note:** Test pattern produces near-worst-case jitter results. Results vary with pattern, unless otherwise noted.)

**EQUALIZER RESIDUAL JITTER vs. CABLE LENGTH (TENSOLITE TWIN-AX, 400mVp-p DIFFERENTIAL INPUT)**

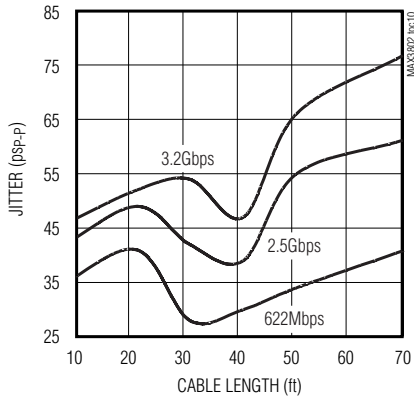

**EQUALIZER RESIDUAL JITTER vs. CABLE LENGTH (RG179B 75Ω COAXIAL, 300mVp-p SINGLE ENDED)**

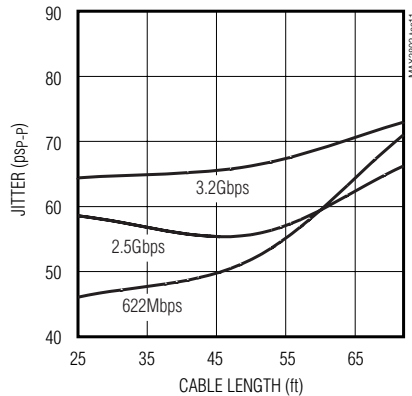

**EQUALIZER RESIDUAL JITTER vs. LINE LENGTH (FR-4 6mil STRIPLINE, 300mVp-p SINGLE ENDED)**

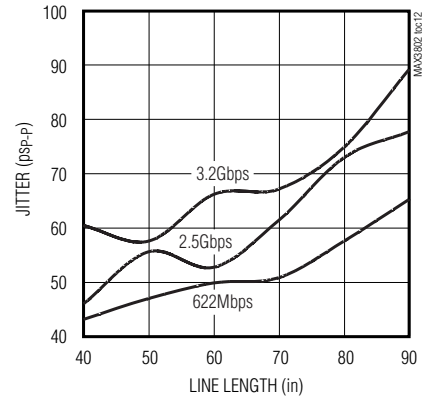

**CIM VOLTAGE vs. CABLE LENGTH (TENSOLITE TWIN-AX, 400mVp-p DIFFERENTIAL)**

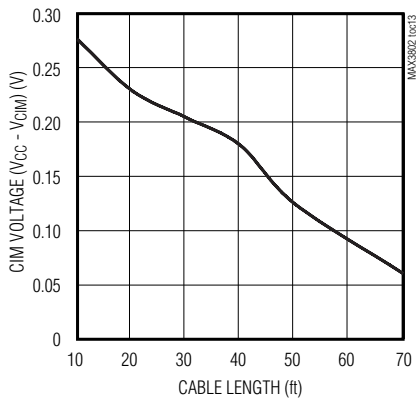

**EQUALIZER INPUT AFTER 115ft OF CABLE (TOP) EQUALIZER OUTPUT (BOTTOM)**

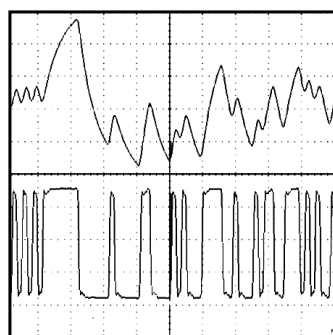

**EQUALIZER OUTPUT EYE DIAGRAM AFTER 155ft OF 50Ω GORE-89 CABLE (400mVp-p)**

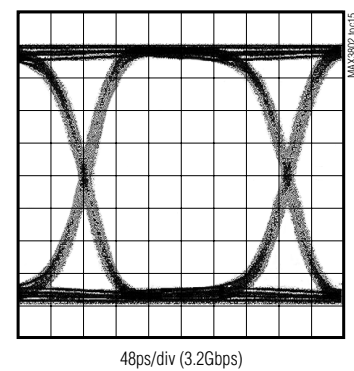

**CABLE OUTPUT EYE DIAGRAM AFTER 70ft OF TENSOLITE TWIN-AX CABLE ( $2^7 - 1$  PRBS NO EQUALIZATION)**

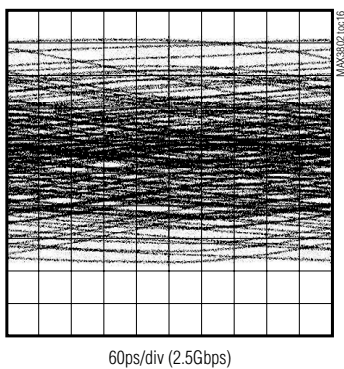

**EQUALIZER OUTPUT EYE DIAGRAM AFTER 70ft OF TENSOLITE TWIN-AX CABLE ( $2^7 - 1$  PRBS)**

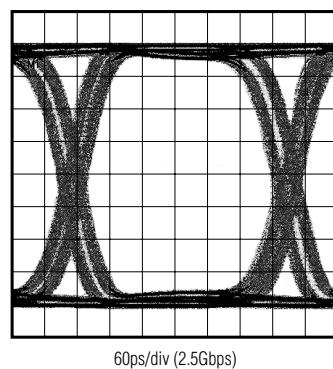

**EQUALIZER OUTPUT EYE DIAGRAM AFTER 72ft OF 75Ω RG179 CABLE (300mVp-p SINGLE ENDED,  $2^{23} - 1$  PRBS)**

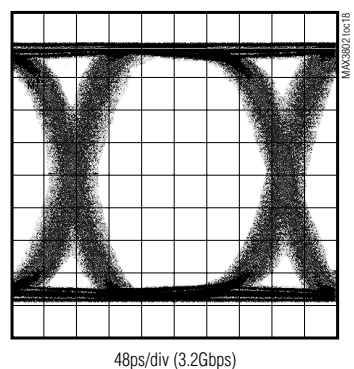

## 3.2Gbps Quad Adaptive Cable Equalizer with Cable Driver

### Typical Operating Characteristics (continued)

( $V_{CC} = 3.3V$ ,  $T_A = +25^\circ C$ , all jitter measurements done at 3.2Gbps, 600mV cable input with  $2^{13} - 1$  PRBS pattern with 100 consecutive ones and 100 consecutive zeros substituted. **Note:** Test pattern produces near-worst-case jitter results. Results vary with pattern, unless otherwise noted.)

**EQUALIZER OUTPUT EYE DIAGRAM AFTER 60in OF FR-4 6mil STRIPLINE (DIFFERENTIAL,  $2^7 - 1$  PRBS)**

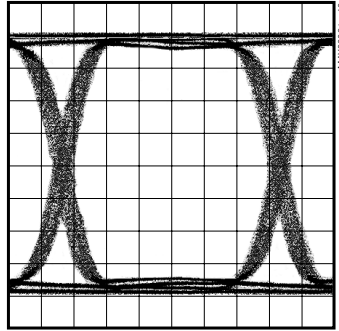

60ps/div (2.5Gbps)

**EQUALIZER OUTPUT EYE DIAGRAM AFTER 288ft OF RG59 CABLE (300mV<sub>p-p</sub> SINGLE ENDED,  $2^{23} - 1$  PRBS)**

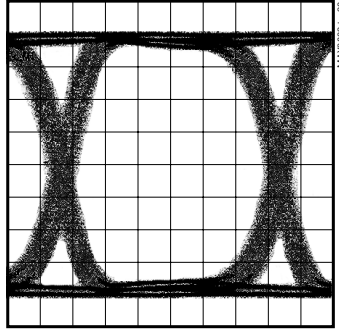

60ps/div (2.5Gbps)

**EQUALIZER OUTPUT EYE DIAGRAM AFTER 50ft OF MADISON 14887 SHIELDED TWISTED-PAIR CABLE ( $2^7 - 1$  PRBS)**

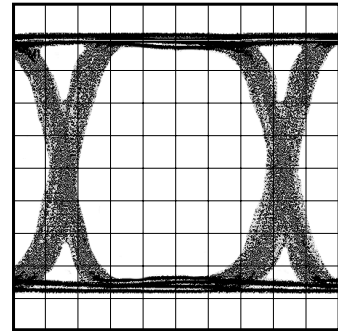

60ps/div (2.5Gbps)

### Pin Description

PIN	NAME	FUNCTION
1, 4, 6, 9	V <sub>CC</sub> E1	3.3V Supply Voltage for Equalizer 1
2	EIN1-	Negative Equalizer 1 Input, CML
3	EIN1+	Positive Equalizer 1 Input, CML
5	CIM1	Cable Integrity Monitor 1 Output
7	EOUT1-	Negative Equalizer 1 Output, CML
8	EOUT1+	Positive Equalizer 1 Output, CML
10	RMOD1	Driver 1 Output Modulation Adjust
11, 14	V <sub>CC</sub> D1	3.3V Supply Voltage for Driver 1
12	DOUT1-	Negative Driver 1 Output, CML
13	DOUT1+	Positive Driver 1 Output, CML
15	DIN1-	Negative Driver 1 Input, CML
16	DIN1+	Positive Driver 1 Input, CML
17	LOS1	Equalizer 1 Loss-of-Signal, TTL, Active Low
18, 21, 23, 26	V <sub>CC</sub> E2	3.3V Supply Voltage for Equalizer 2
19	EIN2-	Negative Equalizer 2 Input, CML
20	EIN2+	Positive Equalizer 2 Input, CML
22	CIM2	Cable Integrity Monitor 2 Output
24	EOUT2-	Negative Equalizer 2 Output, CML
25	EOUT2+	Positive Equalizer 2 Output, CML
27	RMOD2	Driver 2 Output Modulation Adjust
28, 31	V <sub>CC</sub> D2	3.3V Supply Voltage for Driver 2
29	DOUT2-	Negative Driver 2 Output, CML
30	DOUT2+	Positive Driver 2 Output, CML

## 3.2Gbps Quad Adaptive Cable Equalizer with Cable Driver

### Pin Description (continued)

**MAX3802**

PIN	NAME	FUNCTION
32	DIN2-	Negative Driver 2 Input, CML
33	DIN2+	Positive Driver 2 Input, CML
34	$\overline{\text{LOS2}}$	Equalizer 2 Loss-of-Signal, TTL, Active Low
35, 38, 40, 43	V <sub>CCE3</sub>	3.3V Supply Voltage for Equalizer 3
36	EIN3-	Negative Equalizer 3 Input, CML
37	EIN3+	Positive Equalizer 3 Input, CML
39	CIM3	Cable Integrity Monitor 3 Output
41	EOUT3-	Negative Equalizer 3 Output, CML
42	EOUT3+	Positive Equalizer 3 Output, CML
44	RMOD3	Driver 3 Output Modulation Adjust
45, 48	V <sub>CCD3</sub>	3.3V Supply Voltage for Driver 3
46	DOUT3-	Negative Driver 3 Output, CML
47	DOUT3+	Positive Driver 3 Output, CML
49	DIN3-	Negative Driver 3 Input, CML
50	DIN3+	Positive Driver 3 Input, CML
51	$\overline{\text{LOS3}}$	Equalizer 3 Loss-of-Signal, TTL, Active Low
52, 55, 57, 60	V <sub>CCE4</sub>	3.3V Supply Voltage for Equalizer 4
53	EIN4-	Negative Equalizer 4 Input, CML
54	EIN4+	Positive Equalizer 4 Input, CML
56	CIM4	Cable Integrity Monitor 4 Output
58	EOUT4-	Negative Equalizer 4 Output, CML
59	EOUT4+	Positive Equalizer 4 Output, CML
61	RMOD4	Driver 4 Output Modulation Adjust
62, 65	V <sub>CCD4</sub>	3.3V Supply Voltage for Driver 4
63	DOUT4-	Negative Driver 4 Output, CML
64	DOUT4+	Positive Driver 4 Output, CML
66	DIN4-	Negative Driver 4 Input, CML
67	DIN4+	Positive Driver 4 Input, CML
68	$\overline{\text{LOS4}}$	Equalizer 4 Loss-of-Signal, TTL, Active Low
EP	Exposed Pad	Ground. Must be soldered to the circuit board ground for proper thermal and electrical performance (see <i>EP Package</i> ).

# 3.2Gbps Quad Adaptive Cable Equalizer with Cable Driver

## Detailed Description

The MAX3802 has four independent adaptive equalizers (receivers) and four independent drivers. Disconnecting the power pins of unused equalizers and drivers lowers the power consumption of the MAX3802. Equalizer and driver descriptions apply to the four identical sections.

### Cable Driver

The cable driver accepts differential or single-ended CML input data at rates up to 3.2Gbps. The maximum CML output of the driver can be adjusted over a typical range of 445mV to 825mV by changing the value of the RMOD\_ resistor between 10kΩ and 20kΩ (resistor connected between RMOD\_ pin and ground).

### Adaptive Cable Equalizer

The adaptive cable equalizer is capable of equalizing differential or single-ended CML input data at rates up

to 3.2Gbps. It automatically adjusts to attenuation levels of 30dB at 1.6GHz (due to skin-effect losses in copper cable). The equalizer consists of a CML input buffer, a flat-response amplifier, a skin-effect compensation amplifier, a current-steering network, a dual power-detector feedback loop, an output limiting amplifier, and a CML output buffer (Figure 1).

### General Theory of Operation

The shape of the power spectrum of a random bit stream can be described by the square of the well-known sinc function, where  $\text{sinc}(f) = \frac{\sin(\pi f)}{\pi f}$  for  $f \neq 0$ . For sufficiently long bit patterns (nonrandom bit stream),  $\text{sinc}^2(f)$  is a good approximation. From the shape of the  $\text{sinc}^2(f)$  function, the ratio of the power densities at any two frequencies can be estimated. The MAX3802 adaptive equalizer employs this principle by incorporating a feedback loop that continuously monitors the power at high- and low-frequency bands and

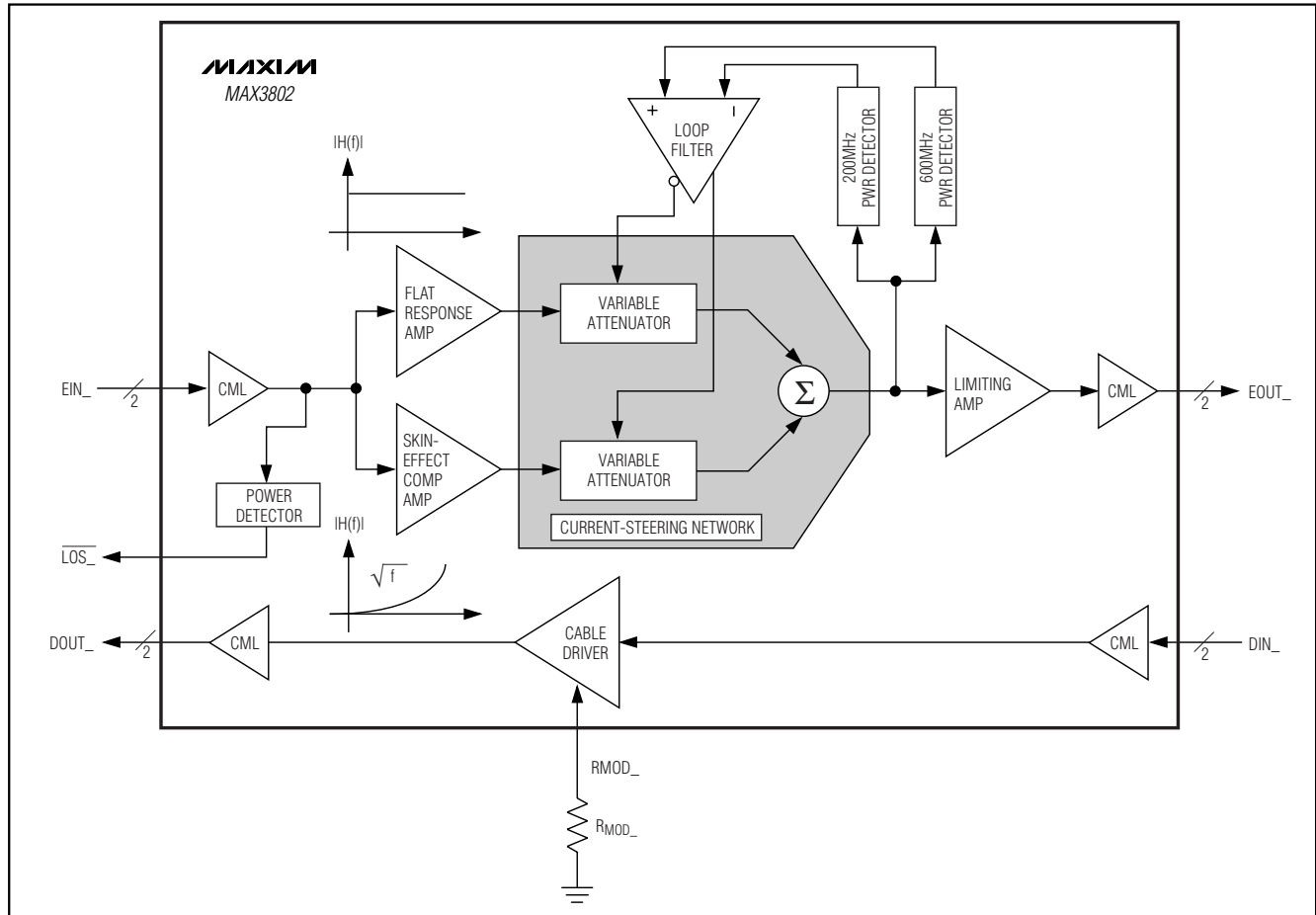

Figure 1. MAX3802 Functional Diagram



# 3.2Gbps Quad Adaptive Cable Equalizer with Cable Driver

dynamically adjusts the equalizer to maintain the correct power ratio.

### CML Input and Output Buffers

The input and output buffers are implemented using CML. Equivalent circuits are shown in Figures 2 and 3. For details on interfacing with CML, refer to Maxim Application Note HFAN-01.0, *Interfacing Between CML, PECL, and LVDS*.

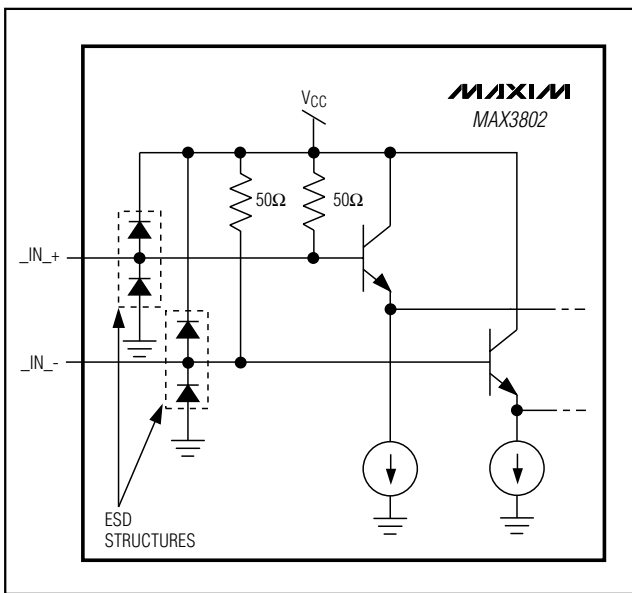

Figure 2. CML Input Structure

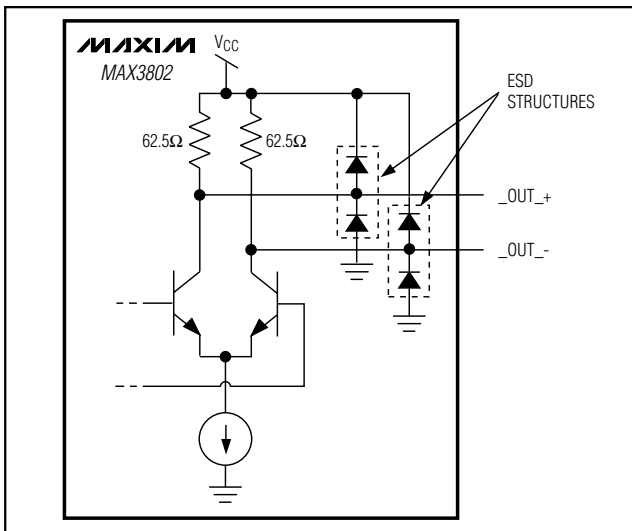

Figure 3. CML Output Structure

### Flat-Response and Skin-Effect Compensation Amplifiers

The buffered input waveform is fed equally to two amplifiers—the flat-response amplifier and the skin-effect compensation amplifier. The flat-response amplifier has a constant gain over the entire frequency range of the device, and the skin-effect compensation amplifier has a gain characteristic that approximates the inverse of the skin-effect attenuation in copper cable. The skin-effect attenuation, in dB per unit length, is proportional to the square root of the frequency. The output currents from the amplifiers are supplied to the current-steering network.

### Current-Steering Network

The function of the current-steering network is to combine adjustable quantities of the output currents from the flat-response and skin-effect compensation amplifiers in order to achieve a desired current ratio. The ratio adjustment is controlled by the dual power-detector feedback loop.

The current-steering network is implemented with a pair of variable attenuators that feed into a current-summing node. The variable attenuators are used to attenuate the output currents of the flat-response and skin-effect compensation amplifiers under control of the dual power-detector feedback loop. The outputs of the two attenuators are combined at the summing node and then fed to the output-limiting amplifier and the feedback loop.

### Dual Power-Detector Feedback Loop

The outputs of the current-steering network are applied to the inputs of 200MHz and 600MHz power detectors. The outputs of the power detectors are applied to the loop-filter amplifier. This amplifier controls the variable attenuators in the current-steering network.

### Output Limiting Amplifier

The output limiting amplifier amplifies the signal from the current-steering network to achieve the specified output voltage swing.

## Applications Information

Refer to Maxim Application Note HFDN-10.0, *Equalizing Gigabit Copper Cable Links with the MAX3800* (available at [www.maxim-ic.com](http://www.maxim-ic.com)) for additional application information.

### Selecting R<sub>MOD</sub>

The cable driver output amplitude can be adjusted by connecting a resistor (R<sub>MOD</sub>) with a value from 10kΩ to 20kΩ between the R<sub>MOD</sub>\_ pin and ground. The exact output amplitude of the driver is dependent on several

# 3.2Gbps Quad Adaptive Cable Equalizer with Cable Driver

factors. See the *Typical Operating Characteristics* Cable Driver Output Voltage vs. RMOD for typical values.

### Cable Integrity Monitor

The CIM\_ output voltage is directly proportional to the output current of the loop amplifier (which controls the current-steering network; see *Detailed Description*). This is an analog voltage output that indicates the amount of equalization being applied.

The amount of equalization (and thus the CIM\_ output level) is affected by cable type, cable length, signal bandwidth, etc. See the *Typical Operating Characteristics* CIM Voltage vs. Cable Length for typical values under specific conditions.

### Loss-of-Signal ( $\overline{\text{LOS}}$ ) Output

Loss of signal is indicated by the  $\overline{\text{LOS}}$ \_ output. A low level on  $\overline{\text{LOS}}$ \_ indicates that the equalizer input power has dropped below a threshold. When there is sufficient input voltage to the channel (typically greater than 250mV),  $\overline{\text{LOS}}$ \_ is high. The  $\overline{\text{LOS}}$ \_ output is suitable for indicating problems with the transmission link caused by, for example, a broken cable or a defective driver.

### Data Spectrum for Equalizer

The MAX3802 equalizer design requires the data stream be scrambled or coded to provide a rich frequency spectrum for the adaptation algorithm. Scrambled patterns or coded patterns with scrambled content, such as 64b/66b or SONET PRBS, are ideal. Some coded patterns, such as 8b/10b, lack low-frequency energy and can be nonoptimal, requiring the user to characterize the specific application. In the absence of an input signal (nonstandard application), amplified noise may appear at the output due to the large gain of the device.

### Single-Ended Operation

For single-ended operation of the cable driver or equalizer, connect the unused input to ground through a series combination of a capacitor (of equal value to other AC-coupling capacitors) and a 50Ω resistor. Note that the MAX3802 is specified for differential operation.

### Layout Considerations

The MAX3802's performance can be significantly affected by circuit board layout and design. Use good high-frequency design techniques, including minimizing ground inductance and using controlled-impedance transmission lines for the high-frequency data signals. Power-supply decoupling capacitors should be placed as close as possible to VCC.

### Exposed-Pad Package

The EP on the 68-pin QFN provides a very low thermal resistance path for heat removal from the IC. The pad is the electrical ground on the MAX3802 and must be soldered to the circuit board ground for proper thermal and electrical performance. Refer to Maxim Application Note HFAN-08.1, *Thermal Considerations for QFN and Other Exposed-Pad Packages* (available at [www.maxim-ic.com](http://www.maxim-ic.com)) for additional application information.

### Chip Information

TRANSISTOR COUNT: 5408

PROCESS: Bipolar (silicon germanium)

### Pin Configuration

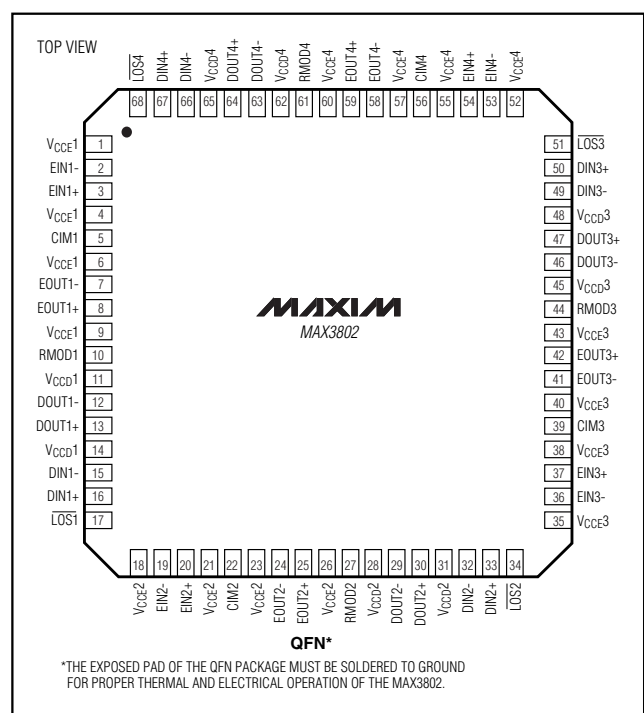

# 3.2Gbps Quad Adaptive Cable Equalizer with Cable Driver

## Package Information

**MAX3802**

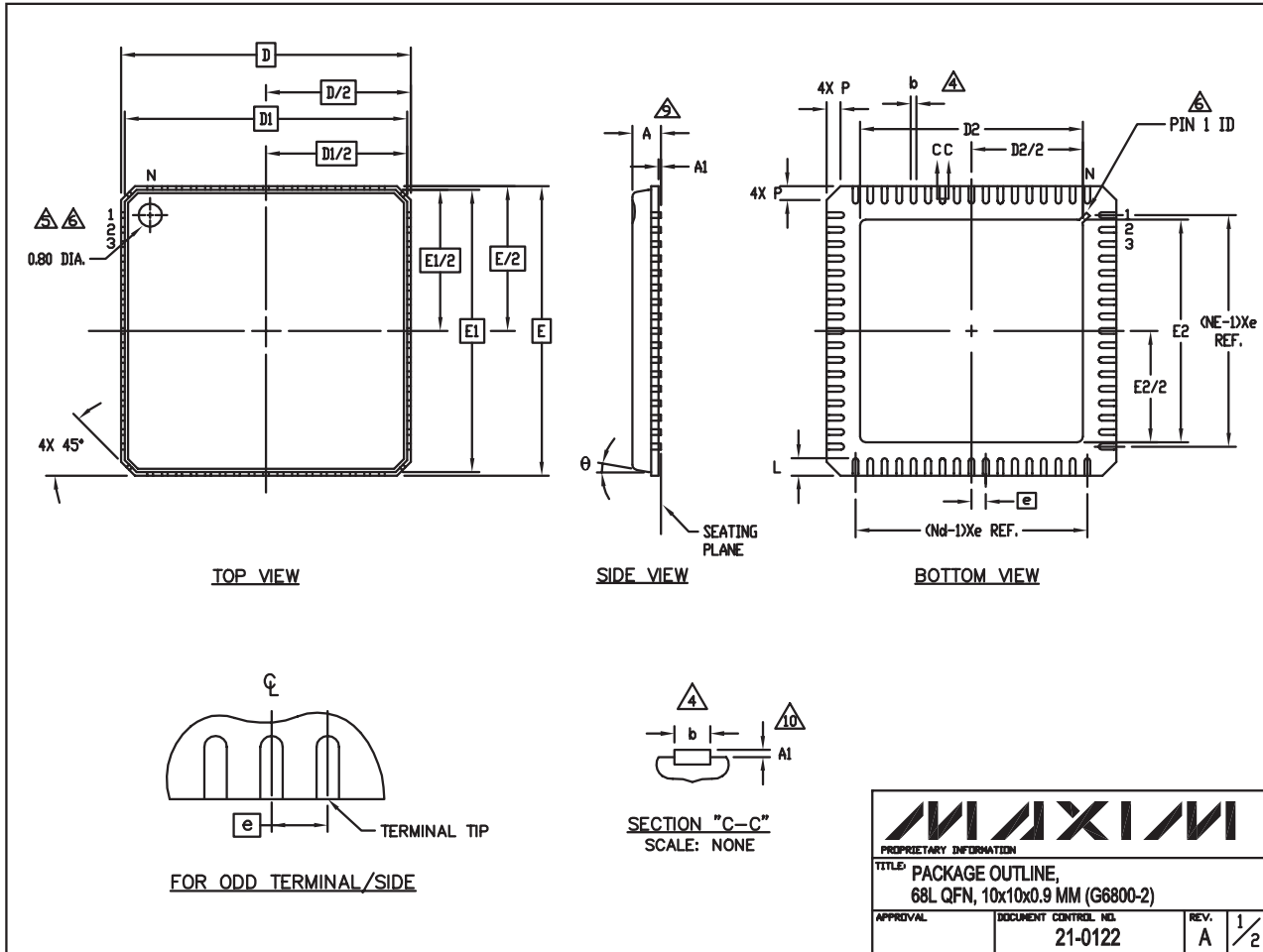

# 3.2Gbps Quad Adaptive Cable Equalizer with Cable Driver

## Package Information (continued)

SYMBOL	COMMON DIMENSIONS			NOTE
	MIN.	NOM.	MAX.	
A	—	0.90	1.00	
A1	0.00	0.01	0.05	11
b	0.18	0.23	0.30	4
D	10.00 BSC			
D1	9.75 BSC			
e	0.50 BSC			
E	10.00 BSC			
E1	9.75 BSC			
L	0.50	0.60	0.75	
N	68			3
Nd	17			3
Ne	17			3
Ø	0		12"	
P	0	0.42	0.60	
D2	4.40	7.70	7.85	
E2	4.40	7.70	7.85	

1. DIE THICKNESS ALLOWABLE IS .012 INCHES MAXIMUM.
2. DIMENSIONING & TOLERANCES CONFORM TO ASME Y14.5M. - 1994.
3. N IS THE NUMBER OF TERMINALS.  
Nd IS THE NUMBER OF TERMINALS IN X-DIRECTION &  
Ne IS THE NUMBER OF TERMINALS IN Y-DIRECTION.
4. DIMENSION b APPLIES TO PLATED TERMINAL AND IS MEASURED BETWEEN 0.20 AND 0.25mm FROM TERMINAL TIP.
5. THE PIN #1 IDENTIFIER MUST BE LOCATED ON THE TOP SURFACE OF THE PACKAGE BY USING INDENTATION MARK OR OTHER FEATURE OF PACKAGE BODY.
6. EXACT SHAPE AND SIZE OF THIS FEATURE IS OPTIONAL.
7. ALL DIMENSIONS ARE IN MILLIMETERS.
8. PACKAGE WARPAGE MAX 0.10mm.
9. APPLIES TO EXPOSED SURFACE OF PADS AND TERMINALS
10. APPLIES ONLY TO TERMINALS.

<b>MAXIM</b>		
<small>PROPRIETARY INFORMATION</small>		
TITLE: PACKAGE OUTLINE, 68L QFN, 10x10x0.9 MM (G6800-2)		
APPROVAL	DOCUMENT CONTROL NO. 21-0122	REV. A 2/2

Maxim cannot assume responsibility for use of any circuitry other than circuitry entirely embodied in a Maxim product. No circuit patent licenses are implied. Maxim reserves the right to change the circuitry and specifications without notice at any time.

12 \_\_\_\_\_ **Maxim Integrated Products, 120 San Gabriel Drive, Sunnyvale, CA 94086 408-737-7600**