

> **Features**

- High Current
- Low On-Resistance
- No Secondary Breakdown
- Low Driving Power
- Avalanche Rated

> **Applications**

- Motor Control
- General Purpose Power Amplifier
- DC-DC converters

> **Outline Drawing**

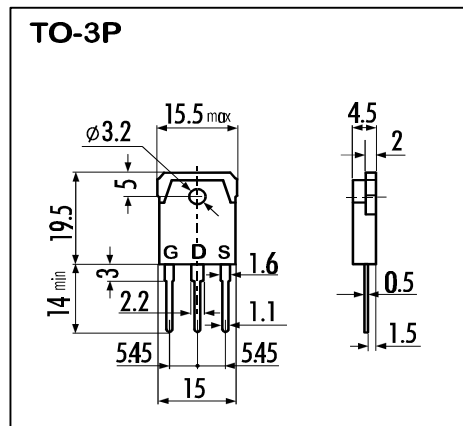

> **Maximum Ratings and Characteristics**

- Absolute Maximum Ratings (T_C=25°C), unless otherwise specified

Item	Symbol	Rating	Unit
Drain-Source-Voltage	V _{DS}	60	V
Continous Drain Current	I _D	±100	A
Pulsed Drain Current	I _{D(puls)}	±400	A
Gate-Source-Voltage	V _{GS}	±20	V
Maximum Avalanche Energy	E _{AV}	1268.3	mJ*
Max. Power Dissipation	P _D	150	W
Operating and Storage Temperature Range	T _{ch}	150	°C
	T _{stg}	-55 ~ +150	°C

L=0.169mH, V_{CC}=24V

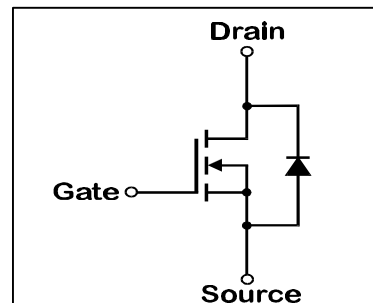

- Electrical Characteristics (T_C=25°C), unless otherwise specified

Item	Symbol	Test conditions	Min.	Typ.	Max.	Unit
Drain-Source Breakdown-Voltage	BV _{DSS}	I _D =1mA V _{GS} =0V	60			V
Gate Threshold Voltage	V _{GS(th)}	I _D =1mA V _{DS} =V _{GS}	1,0	1,5	2,0	V
Zero Gate Voltage Drain Current	I _{DSS}	V _{DS} =60V T _{ch} =25°C		10	500	μA
		V _{GS} =0V T _{ch} =125°C		0,2	1,0	mA
Gate Source Leakage Current	I _{GSS}	V _{GS} =±20V V _{DS} =0V		10	100	nA
Drain Source On-State Resistance	R _{DS(on)}	I _D =50A V _{GS} =4V		7	11	mΩ
		I _D =50A V _{GS} =10V		5	6,5	mΩ
Forward Transconductance	g _{fs}	I _D =50A V _{DS} =25V	40	80		S
Input Capacitance	C _{iss}	V _{DS} =25V		6700	10050	pF
Output Capacitance	C _{oss}	V _{GS} =0V		2100	3150	pF
Reverse Transfer Capacitance	C _{rss}	f=1MHz		570	860	pF
Turn-On-Time t _{on} (t _{on} =t _{d(on)} +t _r)	t _{d(on)}	V _{CC} =30V		20	30	ns
		V _{GS} =10V		160	300	ns
Turn-Off-Time t _{off} (t _{off} =t _{d(off)} +t _f)	t _{d(off)}	I _D =100A		410	620	ns
		R _{GS} =10 Ω		330	500	ns
Avalanche Capability	I _{AV}	L = 100μH T _{ch} =25°C	100			A
Diode Forward On-Voltage	V _{SD}	I _F =100A V _{GS} =0V T _{ch} =25°C		1,0	1,5	V
Reverse Recovery Time	t _{rr}	I _F =50A V _{GS} =0V		85		ns
Reverse Recovery Charge	Q _{rr}	-di/dt=100A/μs T _{ch} =25°C		0,21		μC

- Thermal Characteristics

Item	Symbol	Min.	Typ.	Max.	Unit
Thermal Resistance	R _{th(ch-c)}			0,83	°C/W
	R _{th(ch-a)}			35,0	°C/W

N-channel MOS-FET			
60V	0,0065Ω	±100A	150W

2SK2898-01

FAP-IIIB Series



> Characteristics

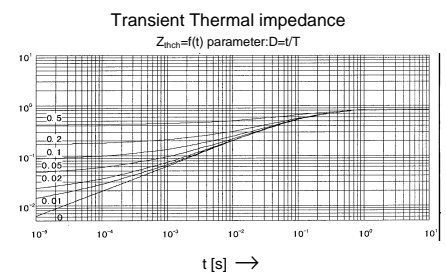
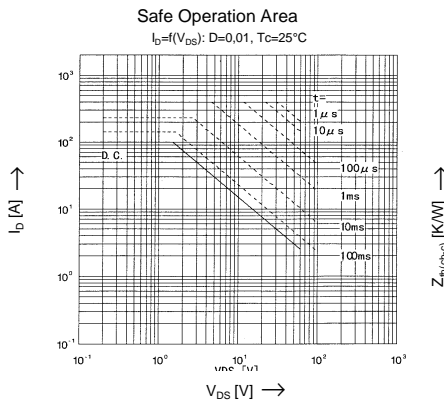
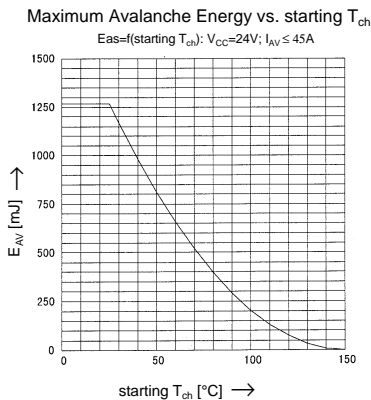
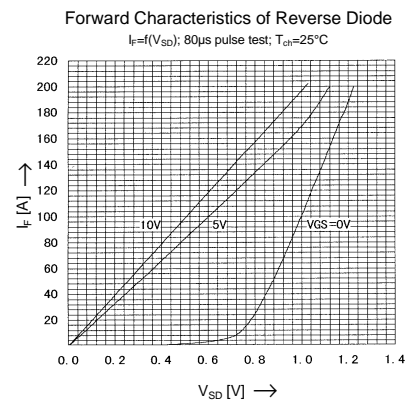
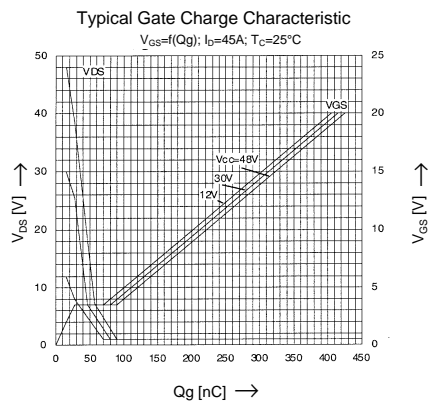
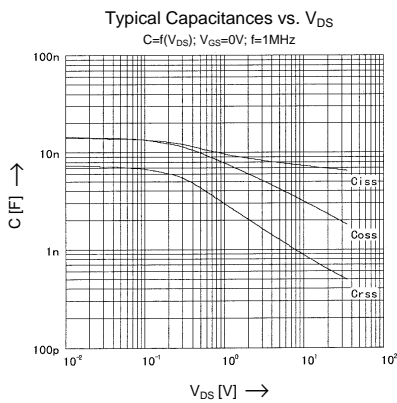
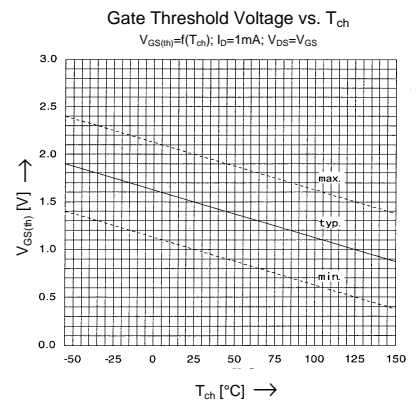
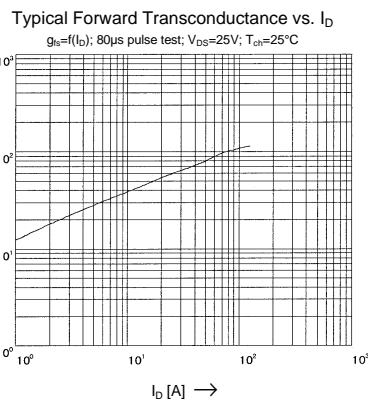
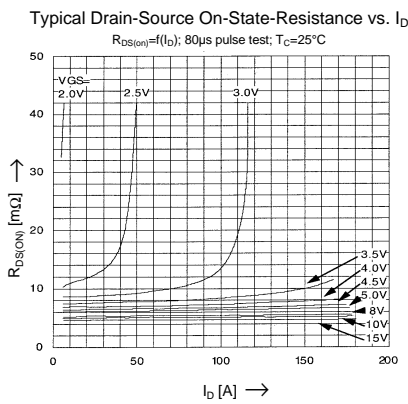
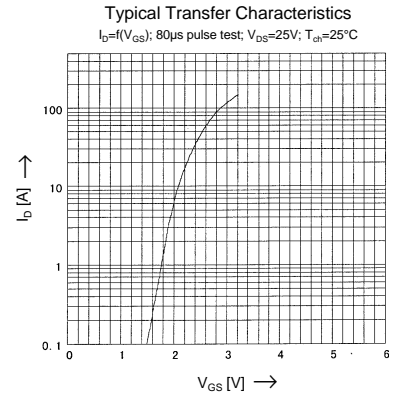
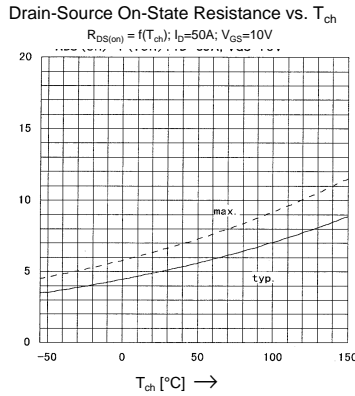
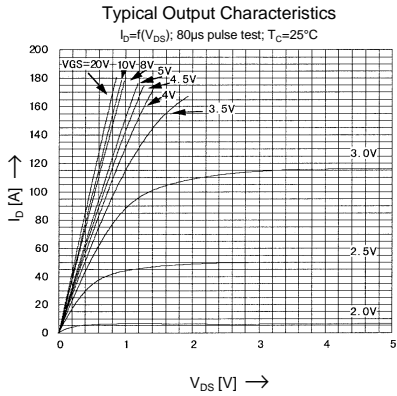

N-channel MOS-FET			
60V	0,0065Ω	±100A	150W

2SK2898-01

FAP-IIIB Series



> Characteristics

Typical Switching Characteristics

t=f(I_b): V_{CC} = 30V, V_{GS} = 10V, R_G = 10Ω

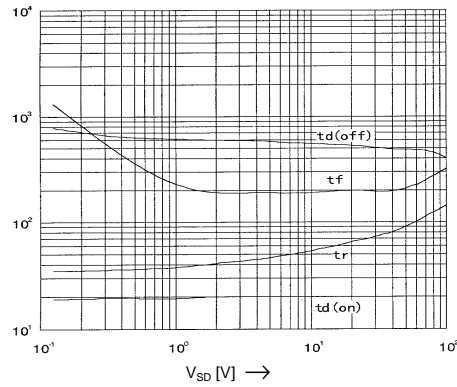

Power Dissipation

$$P_D = f(T_C)$$

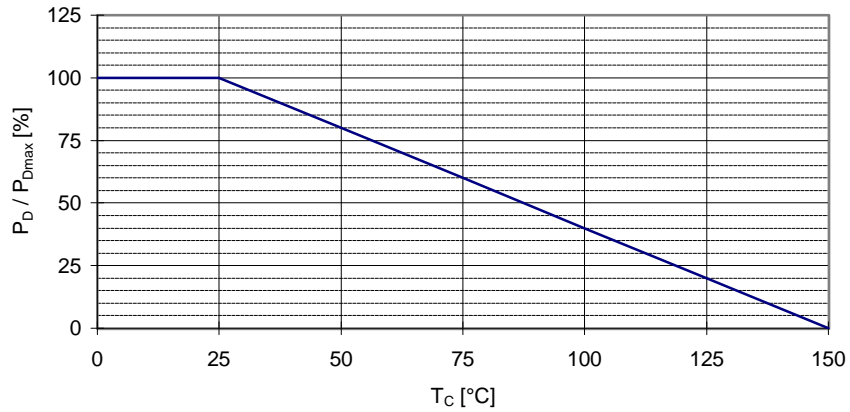

Maximum Avalanche Current vs. starting T_{ch}

$$I_{AV} = f(\text{starting } T_{ch})$$

