

# MBR0540

## Features

- 1.0 Ampere; forward voltage less than 620 mV.
- 400 milliwatt Power Dissipation package.
- Compact surface mount with same footprint as mini-melf.



**SOD123**  
Mark: B4

**Actual Size**

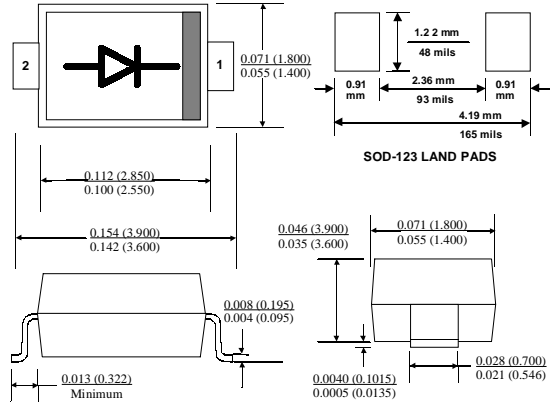

## Ordering:

- 7 inch reel (178 mm); 8 mm Tape; 3,000 units per reel.

## 1.0 Ampere Schottky Power Rectifiers

### Absolute Maximum Ratings\* $T_A = 25^\circ\text{C}$ unless otherwise noted

Symbol	Parameter	Value	Units
$I_O$	Average Rectified Current	500	mA
$I_{f(surge)}$	Peak Forward Surge Current half wave, single phase, 60 Hz Superimposed on rated load (JEDEC method)	5.5	A
$V_{RRM}$	Peak Repetitive Reverse Voltage	40	V
$V_{RWM}$	Working Peak Reverse Voltage	40	V
$V_R$	DC Blocking Voltage	40	V
$R_{\theta JA}$	Thermal Resistance, Junction to Ambient **	206	$^\circ\text{C}/\text{W}$
$R_{\theta JL}$	Thermal Resistance, Junction to Lead ***	118	$^\circ\text{C}/\text{W}$
$T_{stg}$	Storage Temperature Range	-65 to +150	$^\circ\text{C}$
$T_J$	Operating Junction Temperature	-65 to +125	$^\circ\text{C}$

\*These ratings are limiting values above which the serviceability of any semiconductor device may be impaired.

\*\*1.0 inch\* pad size (1.0 x 0.5 inch for each lead) on FR4 board.

\*\*\*Device mounted on FR-4 PCB 0.013 mm.

### Electrical Characteristics $T_A = 25^\circ\text{C}$ unless otherwise noted

Symbol	Parameter	Min	Max	Units	
$I_R$	Reverse Leakage		$V_R = 20\text{ V}, T_A = 25^\circ\text{C}$	10	$\mu\text{A}$
			$V_R = 20\text{ V}, T_A = 100^\circ\text{C}$	5.0	mA
			$V_R = 40\text{ V}, T_A = 25^\circ\text{C}$	20	$\mu\text{A}$
			$V_R = 40\text{ V}, T_A = 100^\circ\text{C}$	13	mA
$V_F$	Forward Voltage (Note 1)		$I_F = 500\text{ mA}, T_A = 25^\circ\text{C}$	510	mV
			$I_F = 500\text{ mA}, T_A = 100^\circ\text{C}$	460	mV
			$I_F = 1.0\text{ A}, T_A = 25^\circ\text{C}$	620	mV
			$I_F = 1.0\text{ A}, T_A = 100^\circ\text{C}$	610	mV

**Note:** Pulse Test: Pulse Width  $\leq 250\mu\text{s}$ , Duty Cycle  $\leq 2.0\%$

Typical Characteristics

Forward Voltage  
vs. Temperature

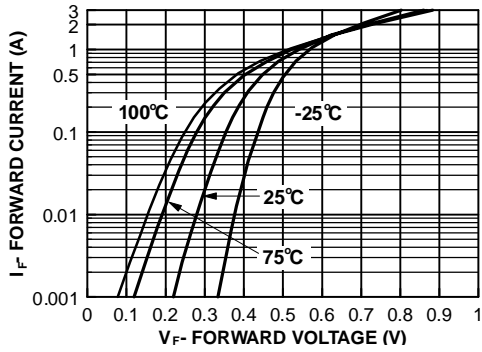

Reverse Leakage Current  
vs. Temperature

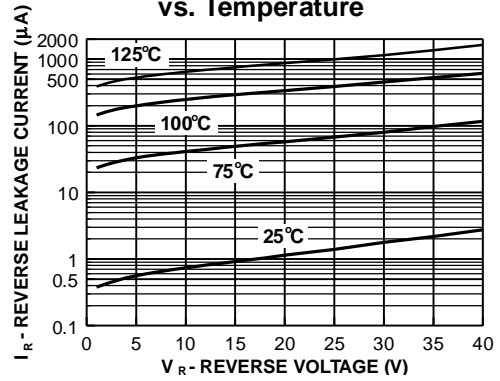

Capacitance  
vs. Reverse Voltage

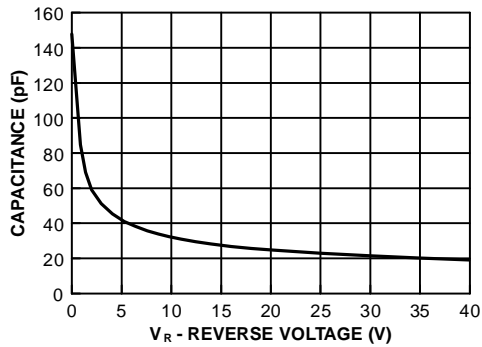

# SOD-123 Tape and Reel Data and Package Dimensions



## SOD123 Packaging Configuration: Figure 1.0

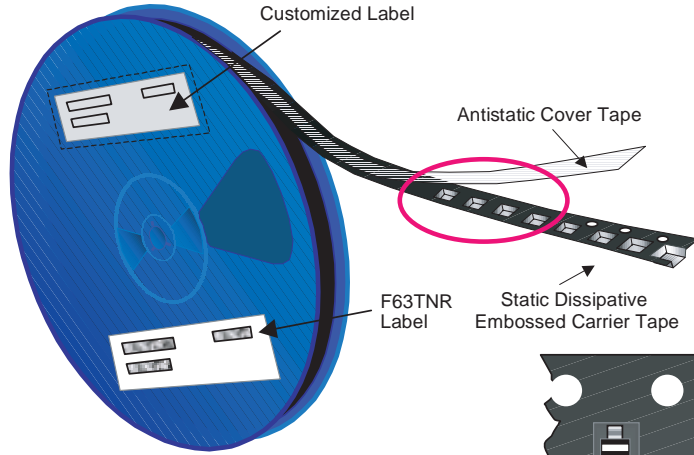

**Packaging Description:**  
 SOD123 parts are shipped in tape. The carrier tape is made from a dissipative (carbon filled) polycarbonate resin. The cover tape is a multilayer film (Heat Activated Adhesive in nature) primarily composed of polyester film, adhesive layer, sealant, and anti-static sprayed agent. These reeled parts in standard option are shipped with 3,000 units per 7" or 177cm diameter reel. The reels are dark blue in color and is made of polystyrene plastic (anti-static coated). Other option comes in 10,000 units per 13" or 330cm diameter reel. This and some other options are described in the Packaging Information table.  
 These full reels are individually barcode labeled and placed inside a pizza box (illustrated in figure 1.0) made of recyclable corrugated brown paper with a Fairchild logo printing. One pizza box contains three reels maximum. And these pizza boxes are placed inside a barcode labeled shipping box which comes in different sizes depending on the number of parts shipped.

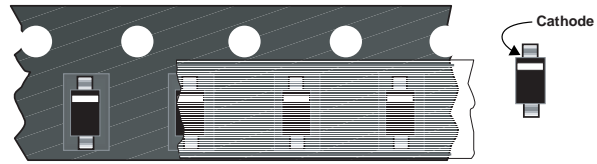

SOD123 Unit Orientation

SOD123 Packaging Information			
Packaging Option	Standard (no flow code)	L99Z	D87Z
Packaging type	TNR	TNR	TNR
Qty per Reel/Tube/Bag	3,000	3,000	10,000
Reel Size	7" Dia	7" Dia	13"
Box Dimension (mm)	184x187x47	184x187x47	343x343x64
Max qty per Box	9,000	9,000	30,000
Weight per unit (gm)	0.01	0.01	0.01
Weight per Reel (kg)	0.123	0.123	0.420
Note/Comments		No marking required	

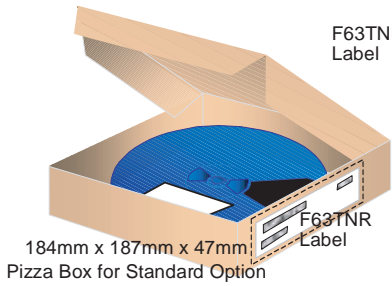
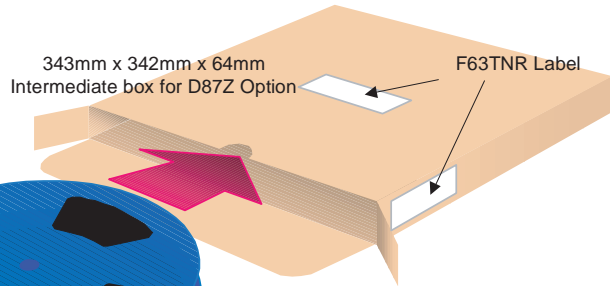

F63TNR Label sample



## SOD123 Tape Leader and Trailer Configuration: Figure 2.0

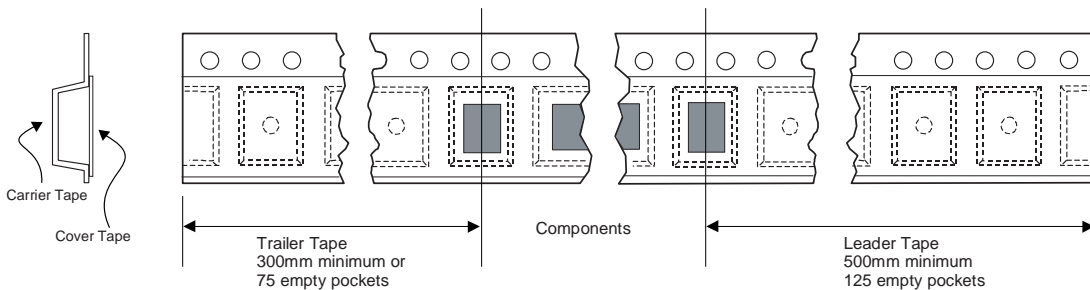

# SOD-123 Tape and Reel Data and Package Dimensions, continued

## SOD123 Embossed Carrier Tape Configuration: Figure 3.0

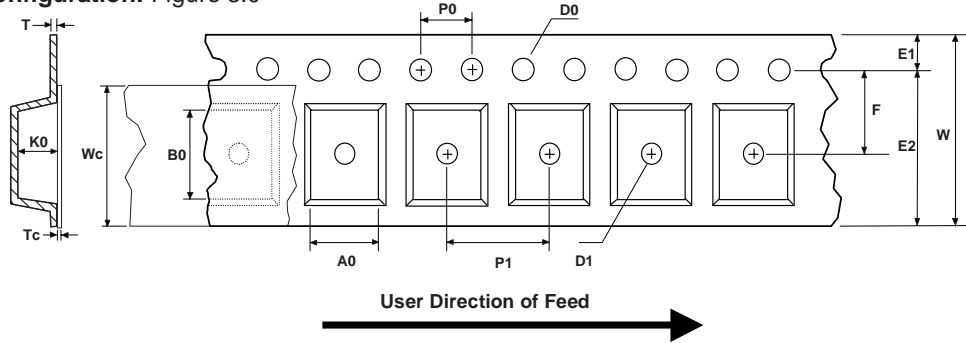

Dimensions are in millimeter														
Pkg type	A0	B0	W	D0	D1	E1	E2	F	P1	P0	K0	T	Wc	Tc
SOD123 (8mm)	1.85 ±0.10	3.94 ±0.10	8.0 ±0.3	1.50 ±0.10	1.125 ±0.125	1.75 ±0.10	6.25 min	3.50 ±0.05	4.0 ±0.1	4.0 ±0.1	1.50 ±0.10	0.200 ±0.020	5.2 ±0.2	0.06 ±0.02

Notes: A0, B0, and K0 dimensions are determined with respect to the EIA/Jedec RS-481 rotational and lateral movement requirements (see sketches A, B, and C).

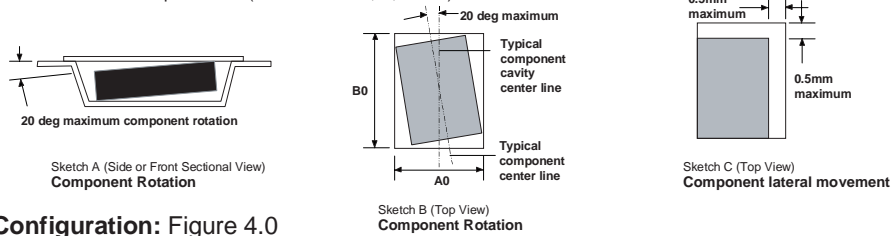

## SOD123 Reel Configuration: Figure 4.0

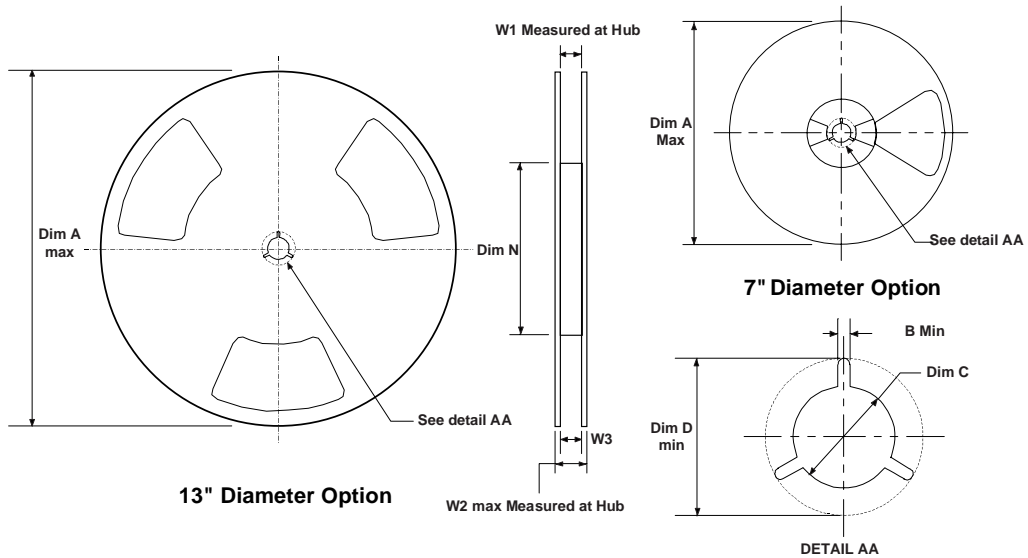

Dimensions are in inches and millimeters									
Tape Size	Reel Option	Dim A	Dim B	Dim C	Dim D	Dim N	Dim W1	Dim W2	Dim W3 (LSL-USL)
8mm	7" Dia	7.00 177.8	0.059 1.5	512 +0.020/-0.008 13 +0.5/-0.2	0.795 20.2	2.165 55	0.331 +0.059/-0.000 8.4 +1.5/0	0.567 14.4	0.311 - 0.429 7.9 - 10.9
8mm	13" Dia	13.00 330	0.059 1.5	512 +0.020/-0.008 13 +0.5/-0.2	0.795 20.2	4.00 100	0.331 +0.059/-0.000 8.4 +1.5/0	0.567 14.4	0.311 - 0.429 7.9 - 10.9

SOD-123 Tape and Reel Data and Package Dimensions, continued

SOD-123 (FS PKG Code D6)

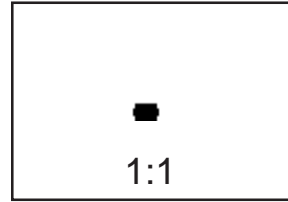

Scale 1:1 on letter size paper

Dimensions shown below are in:  
inches [millimeters]

Part Weight per unit (gram): 0.01

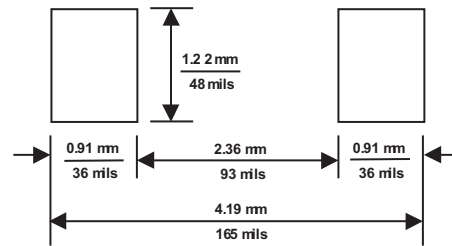
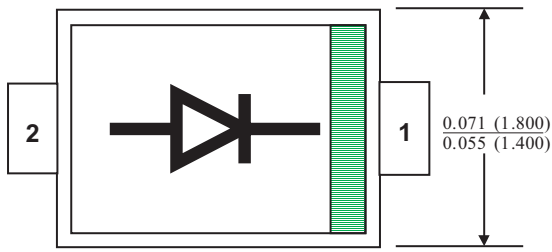

SOD-123 LAND PADS

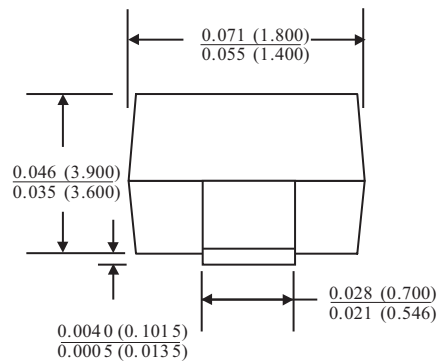
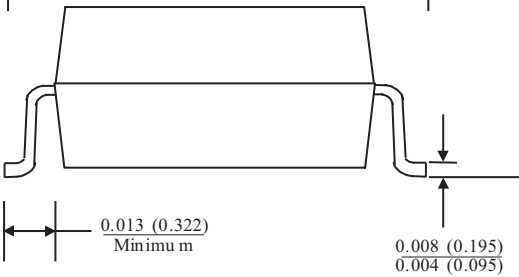
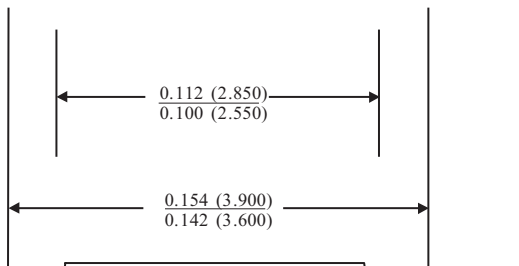

## TRADEMARKS

The following are registered and unregistered trademarks Fairchild Semiconductor owns or is authorized to use and is not intended to be an exhaustive list of all such trademarks.

ACEx™	HiSeC™	SuperSOT™-8
Bottomless™	ISOPLANAR™	SyncFET™
CoolFET™	MICROWIRE™	TinyLogic™
CROSSVOLT™	POP™	UHC™
E <sup>2</sup> CMOS™	PowerTrench®	VCX™
FACT™	QFET™	
FACT Quiet Series™	QS™	
FAST®	Quiet Series™	
FASTr™	SuperSOT™-3	
GTO™	SuperSOT™-6	

## DISCLAIMER

FAIRCHILD SEMICONDUCTOR RESERVES THE RIGHT TO MAKE CHANGES WITHOUT FURTHER NOTICE TO ANY PRODUCTS HEREIN TO IMPROVE RELIABILITY, FUNCTION OR DESIGN. FAIRCHILD DOES NOT ASSUME ANY LIABILITY ARISING OUT OF THE APPLICATION OR USE OF ANY PRODUCT OR CIRCUIT DESCRIBED HEREIN; NEITHER DOES IT CONVEY ANY LICENSE UNDER ITS PATENT RIGHTS, NOR THE RIGHTS OF OTHERS.

## LIFE SUPPORT POLICY

FAIRCHILD'S PRODUCTS ARE NOT AUTHORIZED FOR USE AS CRITICAL COMPONENTS IN LIFE SUPPORT DEVICES OR SYSTEMS WITHOUT THE EXPRESS WRITTEN APPROVAL OF FAIRCHILD SEMICONDUCTOR CORPORATION. As used herein:

1. Life support devices or systems are devices or systems which, (a) are intended for surgical implant into the body, or (b) support or sustain life, or (c) whose failure to perform when properly used in accordance with instructions for use provided in the labeling, can be reasonably expected to result in significant injury to the user.
2. A critical component is any component of a life support device or system whose failure to perform can be reasonably expected to cause the failure of the life support device or system, or to affect its safety or effectiveness.

## PRODUCT STATUS DEFINITIONS

### Definition of Terms

Datasheet Identification	Product Status	Definition
Advance Information	Formative or In Design	This datasheet contains the design specifications for product development. Specifications may change in any manner without notice.
Preliminary	First Production	This datasheet contains preliminary data, and supplementary data will be published at a later date. Fairchild Semiconductor reserves the right to make changes at any time without notice in order to improve design.
No Identification Needed	Full Production	This datasheet contains final specifications. Fairchild Semiconductor reserves the right to make changes at any time without notice in order to improve design.
Obsolete	Not In Production	This datasheet contains specifications on a product that has been discontinued by Fairchild semiconductor. The datasheet is printed for reference information only.