

MAXIM

Video Operational Amplifier

MAX404

General Description

The MAX404 is a high-speed operational amplifier optimized for exceptional AC performance, output drive and stability while operating from $\pm 5V$ power supplies. Featuring 80MHz gain-bandwidth, 500V/ μs slew rate and 0.01°/0.05% differential phase and gain, this amplifier is ideal for video and other high-speed applications.

The MAX404 remains stable while driving unlimited capacitive loads. As a result, flash A/D converter inputs, long distance coaxial cables, and other large or varying capacitive loads can be driven without output oscillations or ringing.

Unlike current-feedback amplifiers, the MAX404 can be used in virtually all high-speed op amp applications because it has fully symmetric differential inputs, 70dB common-mode rejection ratio (CMRR), and 66dB of open-loop gain.

The MAX404 guarantees 50mA continuous output current and $\pm 3V$ swing into 100 Ω . Stable for gains of 2V/V or greater, the amplifier is optimized for applications such as 50 Ω and 75 Ω coaxial cable drivers in video test equipment, radar displays, medical imaging, and RGB systems.

Applications

- Video Coax Line Drivers
- Video Distribution
- Flash A/D Converter Input Amplifier
- High-Speed Signal Processing
- Pulse & RF Amplifiers
- High Resolution Video
- Medical Imaging

Pin Configuration

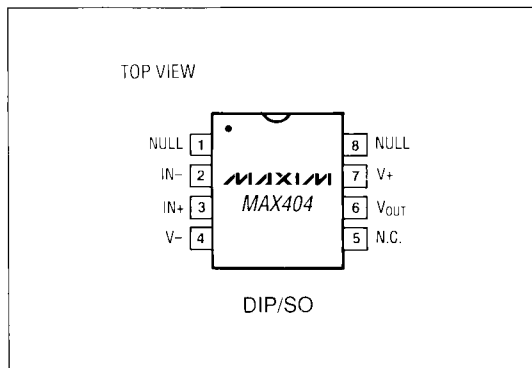

Features

- 0.01°/0.05% Differential Phase/Gain
- 80MHz Gain Bandwidth
- 500V/ μs Slew Rate
- 50mA Continuous Output Current
- Stable with Any Capacitive Load
- 66dB Open-Loop Gain
- 70dB CMRR

Ordering Information

PART	TEMP. RANGE	PIN-PACKAGE
MAX404CPA	0° C to +70° C	8 Plastic DIP
MAX404CSA	0° C to +70° C	8 SO
MAX404C/D	0° C to +70° C	Dice*
MAX404EPA	-40° C to +85° C	8 Plastic DIP
MAX404ESA	-40° C to +85° C	8 SO

* Dice are tested at 25° C only

Typical Application Circuit

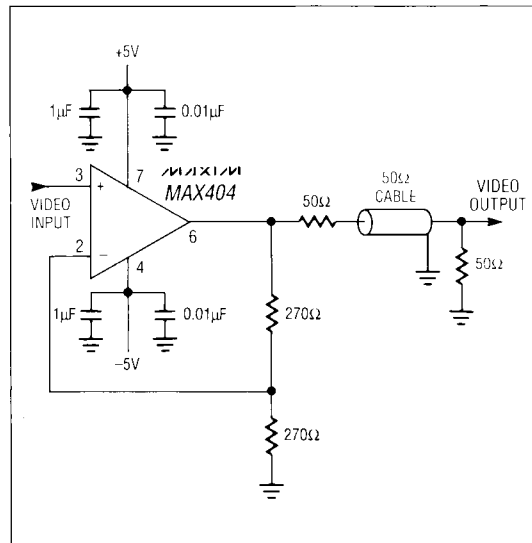

Video Operational Amplifier

ABSOLUTE MAXIMUM RATINGS

Total Supply Voltage (V+ to V-) 12V
 Voltage at any pin (V- -0.3V) to (V+ +0.3V)
 Output Short-Circuit to GND 60 sec
 Continuous Power Dissipation (T_A = +70°C)
 Plastic DIP (derate 9.0mW/°C above +70°C) 725mW
 SO (derate 6mW/°C above +70°C) 470mW

Operating Temperature Ranges: (T_{AMIN}-T_{AMAX})
 MAX404C_A 0°C to +70°C
 MAX404E_A -40°C to +85°C
 Storage Temperature Range -55°C to +125°C
 Lead Temperature (soldering, 10 sec) +300°C

Stresses beyond those listed under "Absolute Maximum Ratings" may cause permanent damage to the device. These are stress ratings only, and functional operation of the device at these or any other conditions beyond those indicated in the operational sections of the specifications is not implied. Exposure to absolute maximum rating conditions for extended periods may affect device reliability.

ELECTRICAL CHARACTERISTICS

(V+ = +5V, V- = -5V, -3V < V_{IN} < +3V, R_L = 100Ω, C_L = 15pF, unless otherwise noted.)

PARAMETER	SYMBOL	CONDITIONS	T _A = +25°C			T _A = T _{AMIN} to T _{AMAX}			UNITS
			MIN	TYP	MAX	MIN	TYP	MAX	
Input Offset Voltage	V _{OS}			±1	±8				mV
		0°C to +70°C					±10		
		-40°C to +85°C						±12	
Input Offset-Voltage Tempco	ΔV _{OS} /ΔT						±20		μV/°C
Input Bias Current (Note 1)	I _B			±1	±3				μA
		0°C to +70°C					±5		
		-40°C to +85°C						±8	
Common-Mode Input Resistance	R _{IN}			1					MΩ
Input Capacitance	C _{IN}			3					pF
Common-Mode Input Voltage Range	V _{IN}			±3	±3.5		±3		V
Large Signal Gain	A _{VOL}	V _{OUT} = 6V _{P-P}		54	66		54		dB
Output Voltage Swing	V _{OUT}	R _{LOAD} = 100Ω		±3.0	±3.5		±3.0		V
		R _{LOAD} = 50Ω		±2.5	±3.0		±2.5		
Output Current	I _{OUT}	R _{LOAD} = 50Ω		±50			±50		mA
		R _{LOAD} = 0Ω			±90				
Output Resistance	R _{OUT}	Gain = 2V/V		10					mΩ
Power-Supply Rejection Ratio	PSRR	V+, V- = 4.75 to 5.25V		40	50		40		dB
Common-Mode Rejection Ratio	CMRR	V _{IN} = -3V to +3V		60	70		60		dB
Supply Current	I+, I-			25	30	35			mA
		0°C to +70°C					20	45	
		-40°C to +85°C					15	50	

Video Operational Amplifier

MAX404

ELECTRICAL CHARACTERISTICS (continued)

(V+ = +5V, V- = -5V, -3V < V_{IN} < +3V, R_L = 100Ω, C_L = 15pF, unless otherwise noted.)

PARAMETER	SYMBOL	CONDITIONS	T _A = +25°C			T _A = T _{AMIN} to T _{AMAX}			UNITS
			MIN	TYP	MAX	MIN	TYP	MAX	
AC SPECIFICATIONS									
Gain Bandwidth	GBW	Gain = 10V/V	80						MHz
Slew-Rate	SR	3V step	500						V/μs
Full-Power Bandwidth	FPBW	V _{OUT} = 6V _{p-p}	26						MHz
Closed-Loop Bandwidth	BW	Gain = 2V/V	66						MHz
Differential Phase (Note 2)	DP	Gain = 2V/V	0.01						deg
Differential Gain (Note 2)	DG	Gain = 2V/V	0.05						%
Settling Time to 0.1%	t _s	DC Gain = -1V/V, 3V step	70						ns

Note 1: V_{IN} = 0V_{DC}

Note 2: Input test signal: 3.58MHz sine wave of amplitude 40 IRE superimposed on a linear ramp (0 to 100 IRE). 140 IRE = 1.0V_{p-p}.

Pin Description

PIN	NAME	FUNCTION
1, 8	NULL	Input Offset Voltage Null. Connect to one end of 1kΩ potentiometer (wiper to V+).
2	IN-	Amplifier Inverting Input.
3	IN+	Amplifier Noninverting Input.
4	V-	Negative Power Supply. Connect to -5V.
5	N.C.	No Connect (open circuit).
6	V _{OUT}	Amplifier Signal Output.
7	V+	Positive Power Supply. Connect to +5V.

Video Operational Amplifier

Typical Operating Characteristics

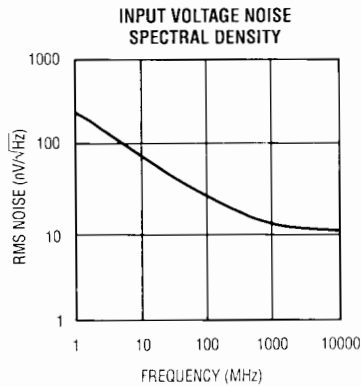
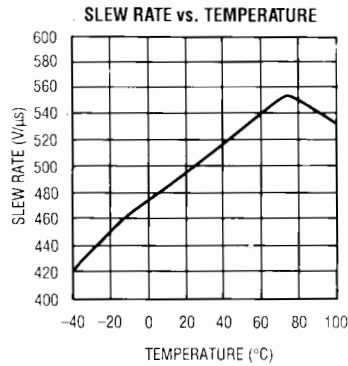
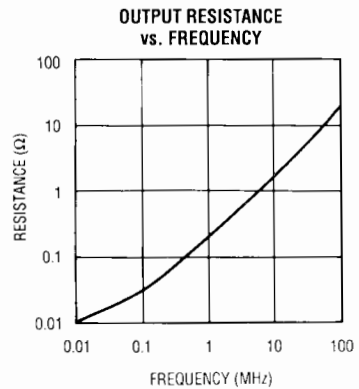
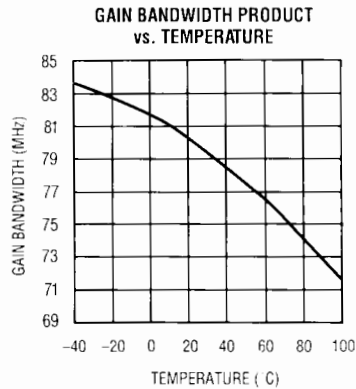
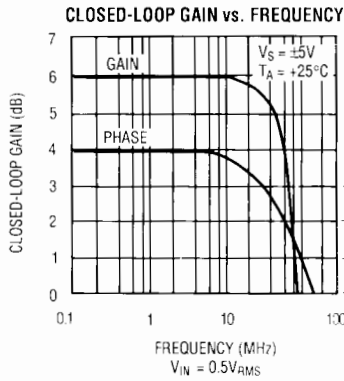
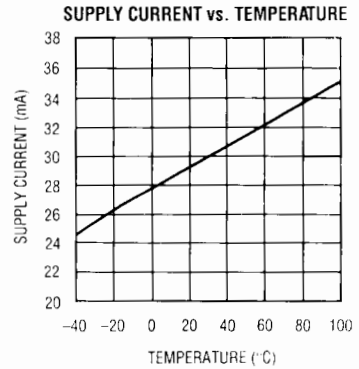
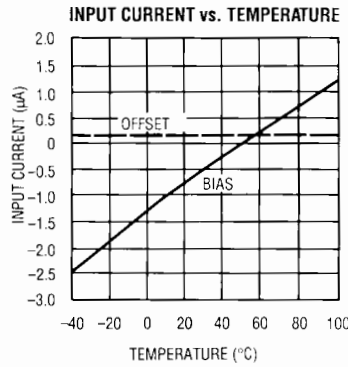
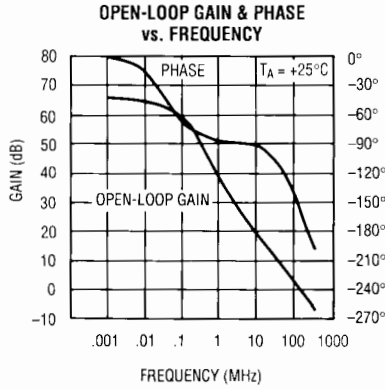

Video Operational Amplifier

MAX404

Detailed Description

Circuit Overview

The MAX404 is a high-frequency bipolar op amp that operates from $\pm 5V$ supplies and can drive $\pm 3.5V$ signals into 50Ω . It has very low output resistance ($10m\Omega$) and can drive large capacitive loads.

The MAX404 is used as both an inverting and noninverting amplifier. As a noninverting amplifier (Figure 1), it is stable with gain as low as $2V/V$. As shown in the inverting configuration (Figure 2) the feedback resistors can be set for a gain as low as $-1V/V$. In both cases, the lower gain limit is set by the feedback resistor ratio, ($R1:R2$) which cannot be less than 1:1.

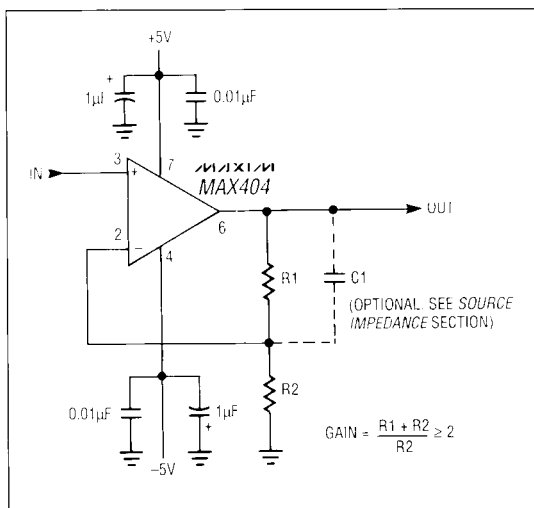

Figure 1. Noninverting Amplifier

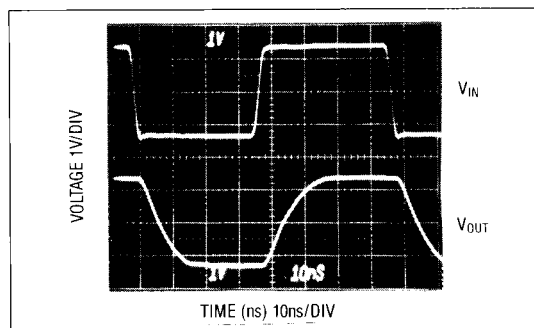

Figure 2. Noninverting Pulse Response

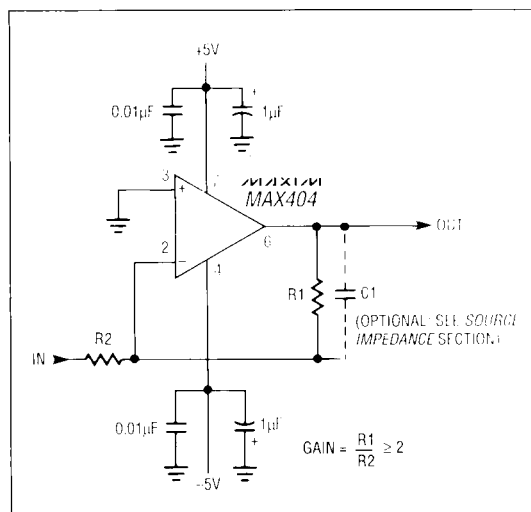

Figure 3. Inverting Amplifier

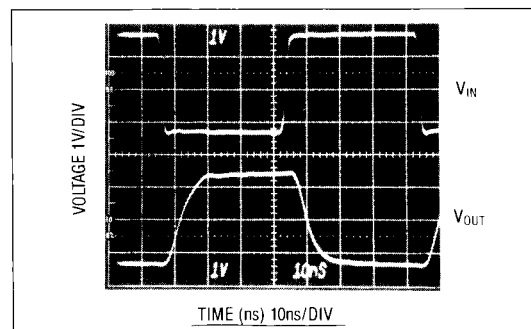

Figure 4. Inverting Pulse Response

Source Impedance

Keep source impedance low to achieve high accuracy. DC errors predominantly result from the input offset voltage and the voltage developed by the input bias current (typically $1\mu A$) through the source resistance. Because the design of the MAX404 is such that balancing the input resistances of the inverting and noninverting inputs may not reduce the input offset voltage. However, resistance in series with the inputs can provide protection by limiting current to the base of each input transistor when the input voltages exceed the $\pm 3V$ common-mode range.

Video Operational Amplifier

AC errors occur in all high-speed op amps. A lowpass RC filter results from the source resistance and the amplifier's input capacitance. Because the MAX404's input capacitance is typically only 3pF and the standard video source impedance is between 25Ω and 37.5Ω (seen at the amplifier's input), the RC filter does not influence performance. To minimize the AC effects of source impedance and input capacitance, source impedance should not exceed 1kΩ.

For applications requiring less overshoot, the input capacitance to the inverting input can be compensated by adding a small capacitor in parallel with the feedback resistor as shown in Figures 1, 3, 5. The capacitance value is strongly dependent on gain and board layout, but is typically 3pF. In standard NTSC, PAL, or SECAM video applications, where gain is usually less than 3V/V and feedback resistances are less than 500Ω, a compensation capacitor is not needed. In the noninverting configuration, performance can also be improved by providing a driven guard ring around the input pin.

Feedback resistors should be less than 1kΩ to insure that the RC time constant formed by the resistor and the amplifier's parasitic capacitance does not limit amplifier high-frequency performance.

Coaxial Driver

Because the MAX404 is designed for closed-loop gains $\geq 2V/V$, it is an excellent choice as a 50Ω or 75Ω back-terminated coaxial cable driver (Figure 5). Even though the op amp is configured for a gain of 2V/V, it acts as a unity-gain buffer due to the voltage divider formed between the back-termination resistor and the load resistor. The signal swing at the output of the cable is the same as the amplifier's input signal.

Two 100Ω or 150Ω loads in parallel (two 50Ω or 75Ω back-terminated loads) can be driven to $\pm 2V$. Each load must have its own back-termination resistor.

Coaxial cable that is not terminated at both ends causes reflections. This produces ringing and increased settling time, seriously degrading pulse response.

Pulse response (see Figures 2 and 4) is achieved by using very short leads and terminations on the coaxial cables. This photo shows response to a 3V_{P-P} signal (from a 50Ω generator) with the op amp configured in a gain of 2V/V, driving a 100Ω load (back-terminated 50Ω). The voltage at the output pin (V_{OUT}) is 6V_{P-P}.

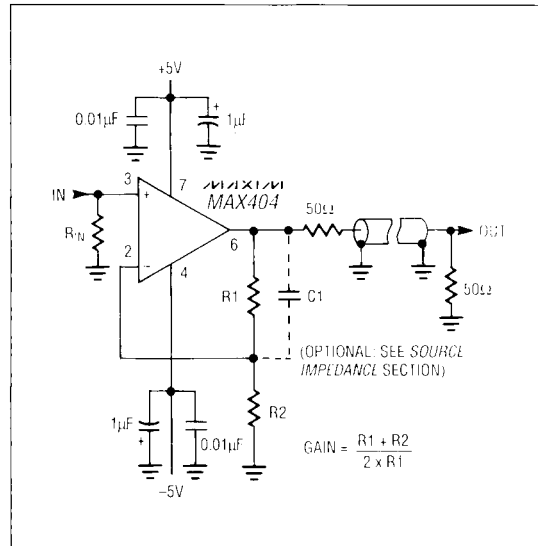

Figure 5. Coaxial Cable Driver

Driving Capacitive Loads

The MAX404 drives large capacitive loads without instability. Figure 6 shows how increased capacitance slows rise and fall times, with minimal ringing. Be aware that as load capacitance, signal amplitude, and frequency increase, the MAX404 output current and power dissipation also increase.

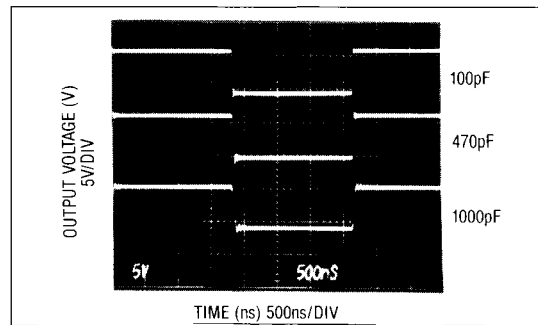

Figure 6. Driving Capacitive Loads

Video Operational Amplifier

Output

V_{OUT} is protected against instantaneous short circuits. Internal current limiting keeps instantaneous output current to safe values, but sustained short circuits can raise the package dissipation beyond the absolute maximum rating. Typical short-circuit output current is 90mA.

Input Offset-Voltage Trim

The MAX404 has an input offset voltage of less than $\pm 8\text{mV}$ at $+25^\circ\text{C}$, which can be reduced further by nulling as shown in Figure 7. This circuit's offset-nulling range is approximately $\pm 10\text{mV}$.

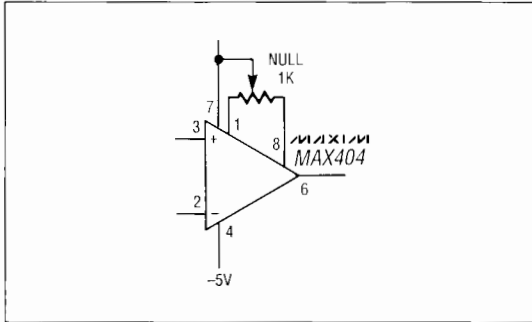
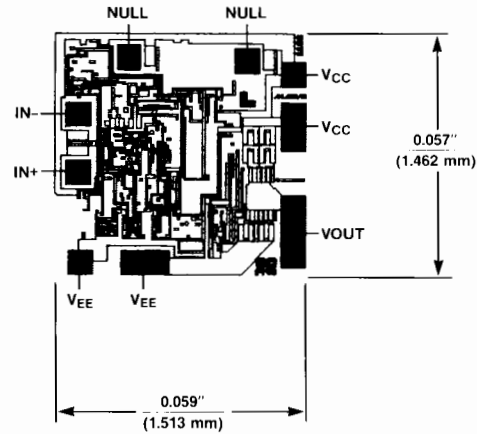

Figure 7. Offset Null Circuit

Bypassing

High-frequency performance requires careful layout, ground planes, and good bypassing. Both supply pins should have a $0.01\mu\text{F}$ ceramic capacitor and a $1\mu\text{F}$ tantalum capacitor to ground. Position these bypass capacitors as close to the supply pins as possible. Surface-mount chip capacitors are recommended because they have extremely low impedance over a wide range of frequencies.

Chip Topography



NOTE: DOUBLE BOND TO RECTANGULAR PADS AND TRIPLE BOND TO V_{OUT} . SUBSTRATE IS CONNECTED TO V_{EE} .

MAX404

MAX404

Video Operational Amplifier

Maxim cannot assume responsibility for use of any circuitry other than circuitry entirely embodied in a Maxim product. No circuit patent licenses are implied. Maxim reserves the right to change the circuitry and specifications without notice at any time.

8 _____ **Maxim Integrated Products, 120 San Gabriel Drive, Sunnyvale, CA 94086 (408) 737-7600**

© 1991 Maxim Integrated Products

Printed USA

MAXIM is a registered trademark of Maxim Integrated Products.