

# DATA SHEET

## **74LVC06A**

Hex inverter with open-drain  
outputs

Product specification  
File under Integrated Circuits, IC24

2000 Mar 07

## Hex inverter with open-drain outputs

## 74LVC06A

## FEATURES

- 5 V tolerant inputs and outputs (open drain) for interfacing with 5 V logic
- Wide supply voltage range from 1.65 to 5.5 V
- CMOS low power consumption
- Direct interface with TTL levels
- Inputs accept voltages up to 5 V
- Complies with JEDEC standard no. 8-1A.

## DESCRIPTION

The 74LVC06A is a high-performance, low-power, low-voltage, Si-gate CMOS device, superior to most advanced CMOS compatible TTL families.

Inputs can be driven from either 3.3 or 5 V devices. This feature allows the use of these devices as translators in a mixed 3.3 to 5 V environment.

The 74LVC06A provides six inverting buffers.

The outputs of the 74LVC06A devices are open drain and can be connected to other open-drain outputs to implement active-LOW wired-OR or active-HIGH wired-AND functions.

## QUICK REFERENCE DATA

GND = 0 V;  $T_{amb} = 25\text{ }^{\circ}\text{C}$ ;  $t_r = t_f \leq 2.5\text{ ns}$ .

SYMBOL	PARAMETER	CONDITIONS	TYP.	UNIT
$t_{PLZ}/t_{PZL}$	propagation delay nA to nY	$C_L = 50\text{ pF}$ ; $V_{CC} = 3.3\text{ V}$	2.3	ns
$C_I$	input capacitance		5.0	pF
$C_{PD}$	power dissipation capacitance per gate	$V_I = \text{GND to } V_{CC}$ ; note 1	8.0	pF

## Note

1.  $C_{PD}$  is used to determine the dynamic power dissipation ( $P_D$  in  $\mu\text{W}$ ).

$$P_D = C_{PD} \times V_{CC}^2 \times f_i + \Sigma(C_L \times V_{CC}^2 \times f_o) \text{ where:}$$

$f_i$  = input frequency in MHz;

$f_o$  = output frequency in MHz;

$C_L$  = output load capacitance in pF;

$V_{CC}$  = supply voltage in Volts;

$\Sigma(C_L \times V_{CC}^2 \times f_o)$  = sum of the outputs.

## FUNCTION TABLE

See note 1.

INPUT	OUTPUT
nA	nY
L	Z
H	L

## Note

1. H = HIGH voltage level;  
L = LOW voltage level;  
Z = high impedance OFF-state.

# Hex inverter with open-drain outputs

# 74LVC06A

## ORDERING INFORMATION

TYPE NUMBER	PACKAGES				
	TEMPERATURE RANGE	PINS	PACKAGE	MATERIAL	CODE
74LVC06AD	-40 to +85 °C	14	SO	plastic	SOT108-1
74LVC06APW		14	TSSOP	plastic	SOT402-1

## PINNING

PIN	SYMBOL	DESCRIPTION
1, 3, 5, 9, 11 and 13	1A to 6A	data inputs
2, 4, 6, 8, 10 and 12	1Y to 6Y	data outputs
7	GND	ground (0 V)
14	V <sub>CC</sub>	DC supply voltage

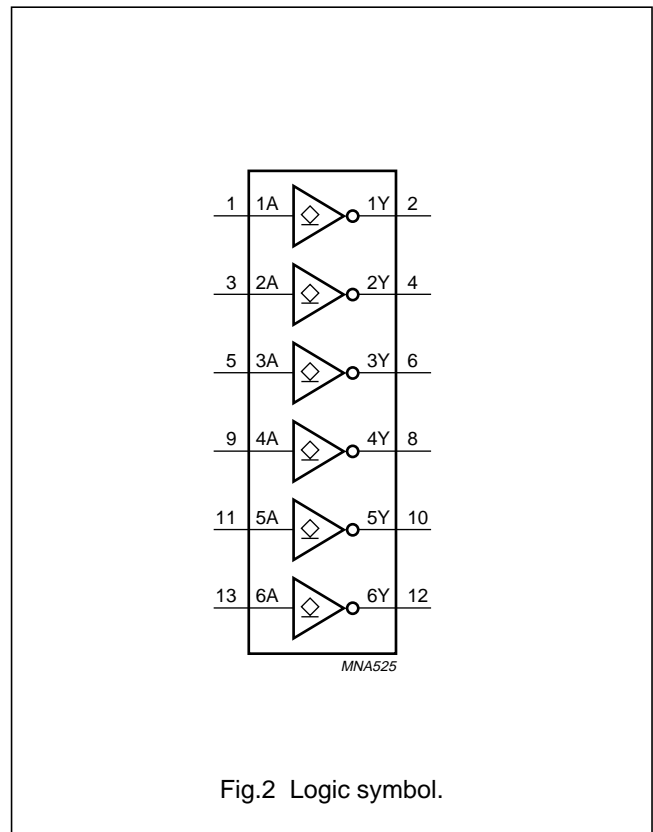
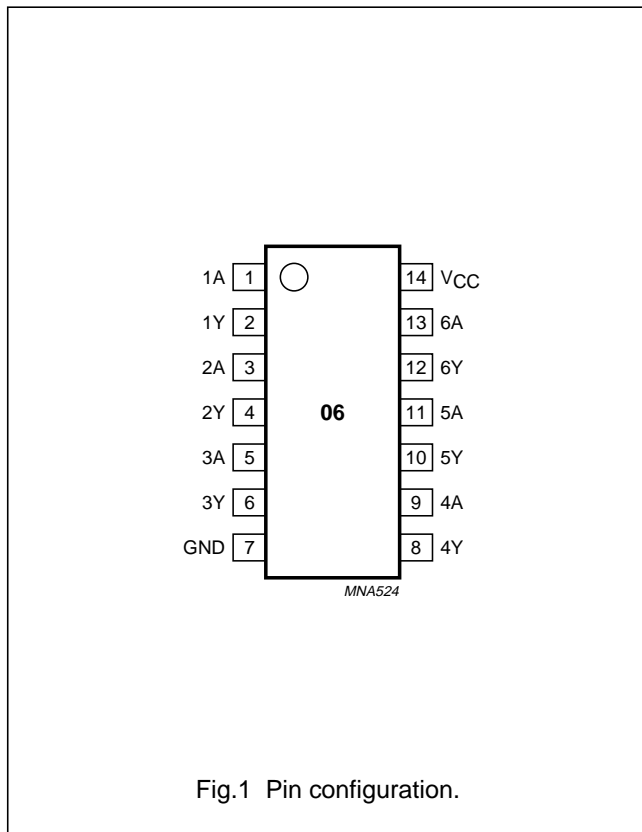

# Hex inverter with open-drain outputs

# 74LVC06A

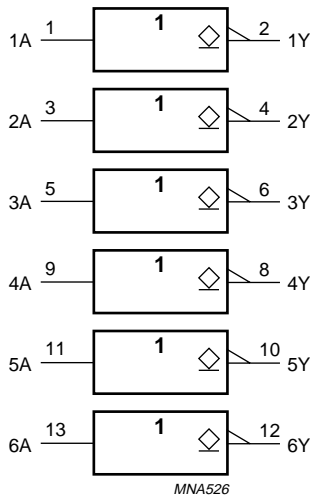

Fig.3 IEC logic symbol.

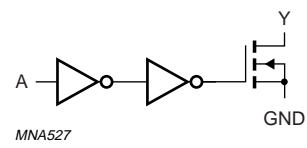

Fig.4 Logic diagram (one gate).

## Hex inverter with open-drain outputs

74LVC06A

## RECOMMENDED OPERATING CONDITIONS

SYMBOL	PARAMETER	CONDITIONS	LIMITS		UNIT
			MIN.	MAX.	
$V_{CC}$	DC supply voltage		1.65	5.5	V
$V_I$	DC input voltage		0	5.5	V
$V_O$	DC output voltage	active mode	0	$V_{CC}$	V
		high-impedance mode	0	5.5	V
$T_{amb}$	operating ambient temperature		-40	+85	°C
$t_r, t_f$	input rise and fall ratios	$V_{CC} = 1.65$ to $2.7$ V	0	20	ns/V
		$V_{CC} = 2.7$ to $5.5$ V	0	10	ns/V

## LIMITING VALUES

In accordance with the Absolute Maximum Rating System (IEC 60134); voltages are referenced to GND (ground = 0 V).

SYMBOL	PARAMETER	CONDITIONS	MIN.	MAX.	UNIT
$V_{CC}$	DC supply voltage		-0.5	+6.5	V
$I_{IK}$	DC input diode current	$V_I < 0$	-	-50	mA
$V_I$	DC input voltage	note 1	-0.5	+6.5	V
$I_{OK}$	DC output clamping diode current	$V_O < 0$	-	-50	mA
$V_O$	DC output voltage	active mode; note 1	-0.5	$V_{CC} + 0.5$	V
		high-impedance mode; note 1	-0.5	+6.5	V
$I_O$	DC output sink current	$V_O = 0$ to $V_{CC}$	-	50	mA
$I_{CC}, I_{GND}$	DC $V_{CC}$ or GND current		-	±100	mA
$T_{stg}$	storage temperature		-65	+150	°C
$P_{tot}$	power dissipation per package				
	SO package	above 70 °C derate linearly with 8 mW/K	-	500	mW
	TSSOP package	above 60 °C derate linearly with 5.5 mW/K	-	500	mW

## Note

1. The input and output voltage ratings may be exceeded if the input and output current ratings are observed.

## Hex inverter with open-drain outputs

## 74LVC06A

**DC CHARACTERISTICS**

Over recommended operating conditions; voltages are referenced to GND (ground = 0 V).

SYMBOL	PARAMETER	TEST CONDITIONS		T <sub>amb</sub> (°C)			UNIT
		OTHER	V <sub>CC</sub> (V)	-40 to +85			
				MIN.	TYP. <sup>(1)</sup>	MAX.	
V <sub>IH</sub>	HIGH-level input voltage		1.65 to 1.95	V <sub>CC</sub>	–	–	V
			2.3 to 2.7	1.7	–	–	V
			2.7 to 3.6	2.0	–	–	V
			4.5 to 5.5	0.7 × V <sub>CC</sub>	–	–	V
V <sub>IL</sub>	LOW-level input voltage		1.65 to 1.95	–	–	GND	V
			2.3 to 2.7	–	–	0.7	V
			2.7 to 3.6	–	–	0.8	V
			4.5 to 5.5	–	–	0.30 × V <sub>CC</sub>	V
V <sub>OL</sub>	LOW-level output voltage	V <sub>I</sub> = V <sub>IH</sub> or V <sub>IL</sub> I <sub>O</sub> = 100 μA I <sub>O</sub> = 4 mA I <sub>O</sub> = 8 mA I <sub>O</sub> = 12 mA I <sub>O</sub> = 24 mA I <sub>O</sub> = 32 mA	1.65 to 5.5	–	–	0.20	V
			1.65	–	–	0.45	V
			2.3	–	–	0.3	V
			2.7	–	–	0.4	V
			3.0	–	–	0.55	V
			4.5	–	–	0.55	V
I <sub>I</sub>	input leakage current	V <sub>I</sub> = 5.5 V or GND	3.6	–	±0.1	±5	μA
I <sub>OZ</sub>	3-state output OFF-state current	V <sub>I</sub> = V <sub>IH</sub> or V <sub>IL</sub> ; V <sub>O</sub> = 5.5 V or GND	3.6	–	0.1	±10	μA
I <sub>off</sub>	power-off leakage current	V <sub>I</sub> or V <sub>O</sub> = 6.5 V	0.0	–	±0.1	±10	μA
I <sub>CC</sub>	quiescent supply current	V <sub>I</sub> = V <sub>CC</sub> or GND; I <sub>O</sub> = 0	5.5	–	0.1	10	μA
ΔI <sub>CC</sub>	additional quiescent supply current per input pin	V <sub>I</sub> = V <sub>CC</sub> – 0.6 V; I <sub>O</sub> = 0	2.3 to 5.5	–	5	500	μA

**Note**1. All typical values are at V<sub>CC</sub> = 3.3 V and T<sub>amb</sub> = 25 °C.

# Hex inverter with open-drain outputs

74LVC06A

## AC CHARACTERISTICS

GND = 0 V;  $V_{CC} \leq 2.7$  V and  $t_r = t_f \leq 2$  ns;  $V_{CC} \geq 2.7$  V and  $t_r = t_f \leq 2.5$  ns.

SYMBOL	PARAMETER	TEST CONDITIONS		T <sub>amb</sub> (°C)			UNIT
		WAVEFORMS	V <sub>CC</sub> (V)	-40 to +85			
				MIN.	TYP. <sup>(1)</sup>	MAX.	
t <sub>PLZ</sub> /t <sub>PZL</sub>	propagation delay nA to nY	see Figs 5 and 6	1.65 to 1.95	–	2.9	–	ns
			2.3 to 2.7	0.5	1.8	3.1	ns
			2.7	0.5	2.5	3.9	ns
			3.0 to 3.6	0.5	2.3	3.7	ns
			4.5 to 5.5	0.5	1.7	3.4	ns

### Note

1. All typical values are measured at T<sub>amb</sub> = 25 °C and at V<sub>CC</sub> respectively 1.8, 2.5, 2.7, 3.3 and 5.0 V.

## AC WAVEFORMS

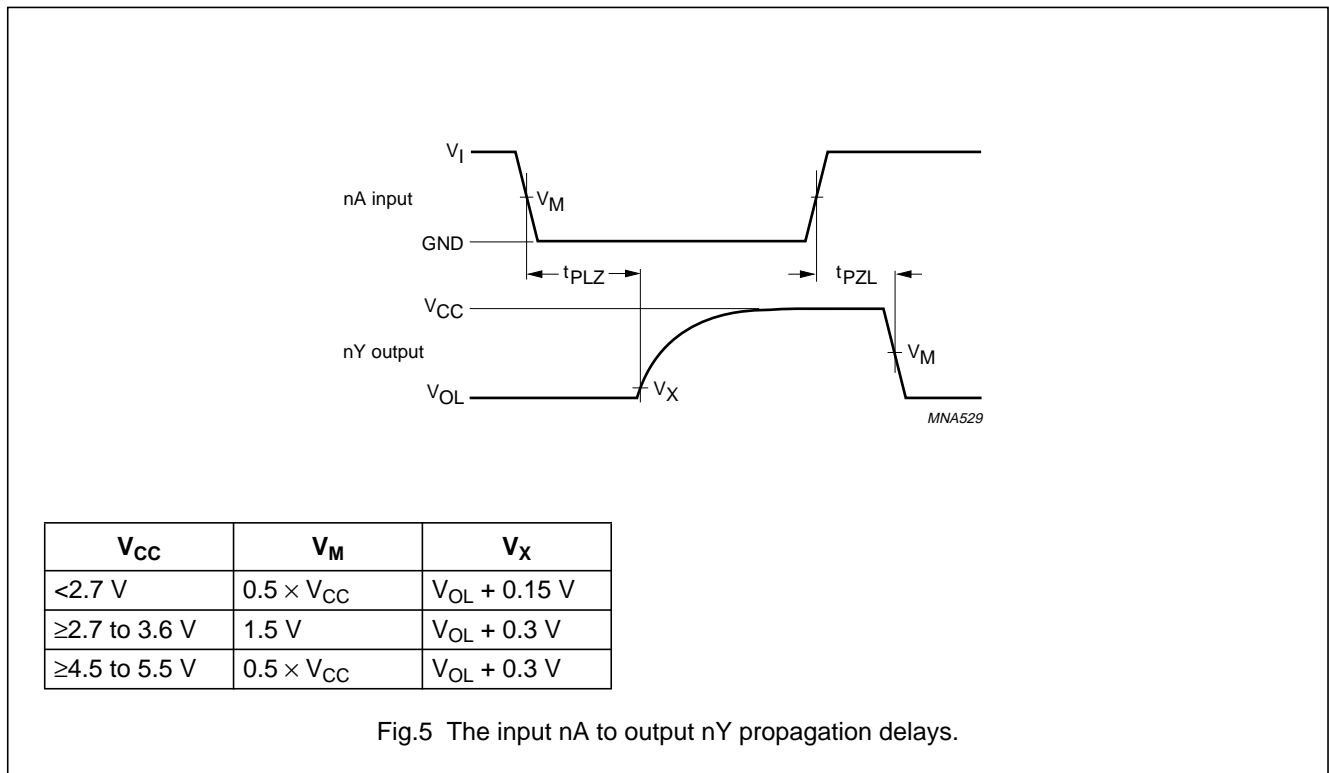

Hex inverter with open-drain outputs

74LVC06A

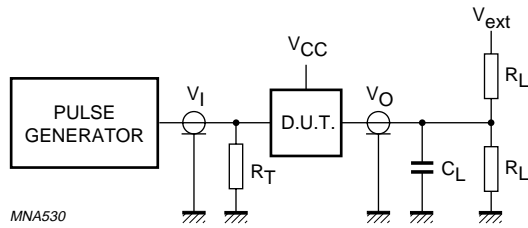

$V_{CC}$	$V_{ext}$	$V_I$	$C_L$	$R_L$
1.65 to 1.95 V	$2 \times V_{CC}$	$V_{CC}$	30 pF	1 k $\Omega$
2.3 to 2.7 V	$2 \times V_{CC}$	$V_{CC}$	30 pF	500 $\Omega$
2.7 V	6 V	2.7 V	50 pF	500 $\Omega$
3.3 to 3.6 V	6 V	2.7 V	50 pF	500 $\Omega$
4.5 to 5.5 V	$2 \times V_{CC}$	$V_{CC}$	50 pF	500 $\Omega$

Fig.6 Load circuitry for switching times.



# Hex inverter with open-drain outputs

74LVC06A

## PACKAGE OUTLINES

SO14: plastic small outline package; 14 leads; body width 3.9 mm

SOT108-1

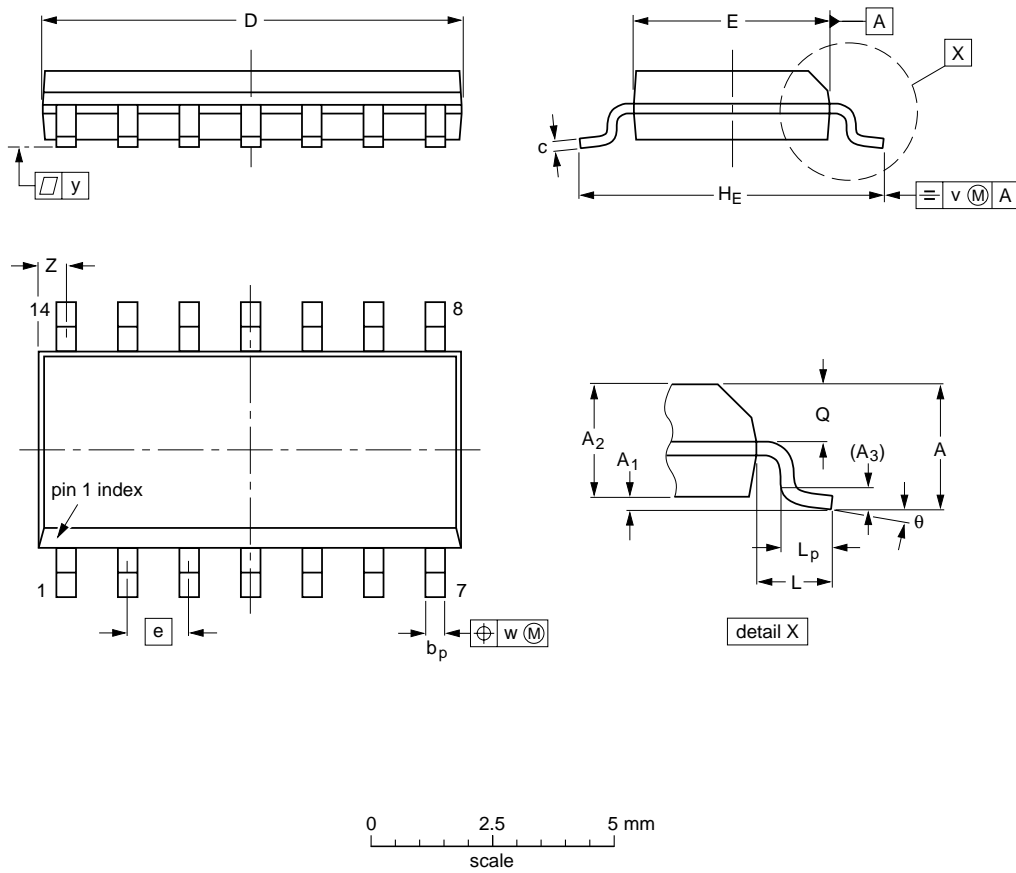

**DIMENSIONS (inch dimensions are derived from the original mm dimensions)**

UNIT	A max.	A <sub>1</sub>	A <sub>2</sub>	A <sub>3</sub>	b <sub>p</sub>	c	D <sup>(1)</sup>	E <sup>(1)</sup>	e	H <sub>E</sub>	L	L <sub>p</sub>	Q	v	w	y	z <sup>(1)</sup>	θ
mm	1.75	0.25 0.10	1.45 1.25	0.25	0.49 0.36	0.25 0.19	8.75 8.55	4.0 3.8	1.27	6.2 5.8	1.05	1.0 0.4	0.7 0.6	0.25	0.25	0.1	0.7 0.3	8° 0°
inches	0.069	0.010 0.004	0.057 0.049	0.01	0.019 0.014	0.0100 0.0075	0.35 0.34	0.16 0.15	0.050	0.244 0.228	0.041	0.039 0.016	0.028 0.024	0.01	0.01	0.004	0.028 0.012	

**Note**

1. Plastic or metal protrusions of 0.15 mm maximum per side are not included.

OUTLINE VERSION	REFERENCES				EUROPEAN PROJECTION	ISSUE DATE
	IEC	JEDEC	EIAJ			
SOT108-1	076E06	MS-012				97-05-22 99-12-27

Hex inverter with open-drain outputs

74LVC06A

TSSOP14: plastic thin shrink small outline package; 14 leads; body width 4.4 mm

SOT402-1

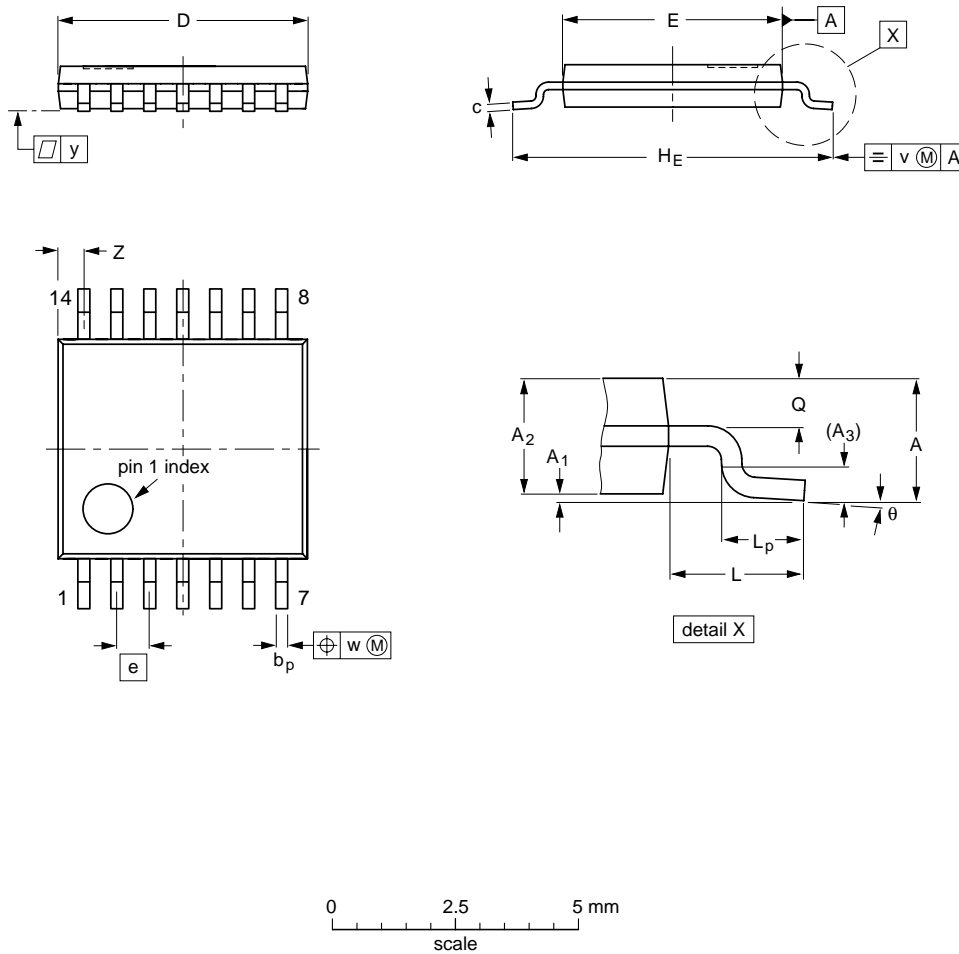

**DIMENSIONS (mm are the original dimensions)**

UNIT	A max.	A <sub>1</sub>	A <sub>2</sub>	A <sub>3</sub>	b <sub>p</sub>	c	D <sup>(1)</sup>	E <sup>(2)</sup>	e	H <sub>E</sub>	L	L <sub>p</sub>	Q	v	w	y	z <sup>(1)</sup>	θ
mm	1.10	0.15 0.05	0.95 0.80	0.25	0.30 0.19	0.2 0.1	5.1 4.9	4.5 4.3	0.65	6.6 6.2	1.0	0.75 0.50	0.4 0.3	0.2	0.13	0.1	0.72 0.38	8° 0°

**Notes**

1. Plastic or metal protrusions of 0.15 mm maximum per side are not included.
2. Plastic interlead protrusions of 0.25 mm maximum per side are not included.

OUTLINE VERSION	REFERENCES				EUROPEAN PROJECTION	ISSUE DATE
	IEC	JEDEC	EIAJ			
SOT402-1		MO-153				95-04-04 99-12-27

## Hex inverter with open-drain outputs

## 74LVC06A

**SOLDERING****Introduction to soldering surface mount packages**

This text gives a very brief insight to a complex technology. A more in-depth account of soldering ICs can be found in our *"Data Handbook IC26; Integrated Circuit Packages"* (document order number 9398 652 90011).

There is no soldering method that is ideal for all surface mount IC packages. Wave soldering is not always suitable for surface mount ICs, or for printed-circuit boards with high population densities. In these situations reflow soldering is often used.

**Reflow soldering**

Reflow soldering requires solder paste (a suspension of fine solder particles, flux and binding agent) to be applied to the printed-circuit board by screen printing, stencilling or pressure-syringe dispensing before package placement.

Several methods exist for reflowing; for example, infrared/convection heating in a conveyor type oven. Throughput times (preheating, soldering and cooling) vary between 100 and 200 seconds depending on heating method.

Typical reflow peak temperatures range from 215 to 250 °C. The top-surface temperature of the packages should preferably be kept below 230 °C.

**Wave soldering**

Conventional single wave soldering is not recommended for surface mount devices (SMDs) or printed-circuit boards with a high component density, as solder bridging and non-wetting can present major problems.

To overcome these problems the double-wave soldering method was specifically developed.

If wave soldering is used the following conditions must be observed for optimal results:

- Use a double-wave soldering method comprising a turbulent wave with high upward pressure followed by a smooth laminar wave.
- For packages with leads on two sides and a pitch (e):
  - larger than or equal to 1.27 mm, the footprint longitudinal axis is **preferred** to be parallel to the transport direction of the printed-circuit board;
  - smaller than 1.27 mm, the footprint longitudinal axis **must** be parallel to the transport direction of the printed-circuit board.

The footprint must incorporate solder thieves at the downstream end.

- For packages with leads on four sides, the footprint must be placed at a 45° angle to the transport direction of the printed-circuit board. The footprint must incorporate solder thieves downstream and at the side corners.

During placement and before soldering, the package must be fixed with a droplet of adhesive. The adhesive can be applied by screen printing, pin transfer or syringe dispensing. The package can be soldered after the adhesive is cured.

Typical dwell time is 4 seconds at 250 °C.

A mildly-activated flux will eliminate the need for removal of corrosive residues in most applications.

**Manual soldering**

Fix the component by first soldering two diagonally-opposite end leads. Use a low voltage (24 V or less) soldering iron applied to the flat part of the lead. Contact time must be limited to 10 seconds at up to 300 °C.

When using a dedicated tool, all other leads can be soldered in one operation within 2 to 5 seconds between 270 and 320 °C.

## Hex inverter with open-drain outputs

74LVC06A

## Suitability of surface mount IC packages for wave and reflow soldering methods

PACKAGE	SOLDERING METHOD	
	WAVE	REFLOW <sup>(1)</sup>
BGA, LFBGA, SQFP, TFBGA	not suitable	suitable
HBCC, HLQFP, HSQFP, HSOP, HTQFP, HTSSOP, SMS	not suitable <sup>(2)</sup>	suitable
PLCC <sup>(3)</sup> , SO, SOJ	suitable	suitable
LQFP, QFP, TQFP	not recommended <sup>(3)(4)</sup>	suitable
SSOP, TSSOP, VSO	not recommended <sup>(5)</sup>	suitable

## Notes

- All surface mount (SMD) packages are moisture sensitive. Depending upon the moisture content, the maximum temperature (with respect to time) and body size of the package, there is a risk that internal or external package cracks may occur due to vaporization of the moisture in them (the so called popcorn effect). For details, refer to the Drypack information in the "Data Handbook IC26; Integrated Circuit Packages; Section: Packing Methods".
- These packages are not suitable for wave soldering as a solder joint between the printed-circuit board and heatsink (at bottom version) can not be achieved, and as solder may stick to the heatsink (on top version).
- If wave soldering is considered, then the package must be placed at a 45° angle to the solder wave direction. The package footprint must incorporate solder thieves downstream and at the side corners.
- Wave soldering is only suitable for LQFP, TQFP and QFP packages with a pitch (e) equal to or larger than 0.8 mm; it is definitely not suitable for packages with a pitch (e) equal to or smaller than 0.65 mm.
- Wave soldering is only suitable for SSOP and TSSOP packages with a pitch (e) equal to or larger than 0.65 mm; it is definitely not suitable for packages with a pitch (e) equal to or smaller than 0.5 mm.

## DEFINITIONS

Data sheet status	
Objective specification	This data sheet contains target or goal specifications for product development.
Preliminary specification	This data sheet contains preliminary data; supplementary data may be published later.
Product specification	This data sheet contains final product specifications.
Limiting values	
Limiting values given are in accordance with the Absolute Maximum Rating System (IEC 60134). Stress above one or more of the limiting values may cause permanent damage to the device. These are stress ratings only and operation of the device at these or at any other conditions above those given in the Characteristics sections of the specification is not implied. Exposure to limiting values for extended periods may affect device reliability.	
Application information	
Where application information is given, it is advisory and does not form part of the specification.	

## LIFE SUPPORT APPLICATIONS

These products are not designed for use in life support appliances, devices, or systems where malfunction of these products can reasonably be expected to result in personal injury. Philips customers using or selling these products for use in such applications do so at their own risk and agree to fully indemnify Philips for any damages resulting from such improper use or sale.

Hex inverter with open-drain outputs

74LVC06A

---

**NOTES**

Hex inverter with open-drain outputs

74LVC06A

---

**NOTES**

Hex inverter with open-drain outputs

74LVC06A

---

**NOTES**

# Philips Semiconductors – a worldwide company

**Argentina:** see South America

**Australia:** 3 Figtree Drive, HOME BUSH, NSW 2140,  
Tel. +61 2 9704 8141, Fax. +61 2 9704 8139

**Austria:** Computerstr. 6, A-1101 WIEN, P.O. Box 213,  
Tel. +43 1 60 101 1248, Fax. +43 1 60 101 1210

**Belarus:** Hotel Minsk Business Center, Bld. 3, r. 1211, Volodarski Str. 6,  
220050 MINSK, Tel. +375 172 20 0733, Fax. +375 172 20 0773

**Belgium:** see The Netherlands

**Brazil:** see South America

**Bulgaria:** Philips Bulgaria Ltd., Energoproject, 15th floor,  
51 James Bourchier Blvd., 1407 SOFIA,  
Tel. +359 2 68 9211, Fax. +359 2 68 9102

**Canada:** PHILIPS SEMICONDUCTORS/COMPONENTS,  
Tel. +1 800 234 7381, Fax. +1 800 943 0087

**China/Hong Kong:** 501 Hong Kong Industrial Technology Centre,  
72 Tat Chee Avenue, Kowloon Tong, HONG KONG,  
Tel. +852 2319 7888, Fax. +852 2319 7700

**Colombia:** see South America

**Czech Republic:** see Austria

**Denmark:** Sydhavnsgade 23, 1780 COPENHAGEN V,  
Tel. +45 33 29 3333, Fax. +45 33 29 3905

**Finland:** Sinikalliontie 3, FIN-02630 ESPOO,  
Tel. +358 9 615 800, Fax. +358 9 6158 0920

**France:** 51 Rue Carnot, BP317, 92156 SURESNES Cedex,  
Tel. +33 1 4099 6161, Fax. +33 1 4099 6427

**Germany:** Hammerbrookstraße 69, D-20097 HAMBURG,  
Tel. +49 40 2353 60, Fax. +49 40 2353 6300

**Hungary:** see Austria

**India:** Philips INDIA Ltd, Band Box Building, 2nd floor,  
254-D, Dr. Annie Besant Road, Worli, MUMBAI 400 025,  
Tel. +91 22 493 8541, Fax. +91 22 493 0966

**Indonesia:** PT Philips Development Corporation, Semiconductors Division,  
Gedung Philips, Jl. Buncit Raya Kav.99-100, JAKARTA 12510,  
Tel. +62 21 794 0040 ext. 2501, Fax. +62 21 794 0080

**Ireland:** Newstead, Clonskeagh, DUBLIN 14,  
Tel. +353 1 7640 000, Fax. +353 1 7640 200

**Israel:** RAPAC Electronics, 7 Kehilat Saloniki St, PO Box 18053,  
TEL AVIV 61180, Tel. +972 3 645 0444, Fax. +972 3 649 1007

**Italy:** PHILIPS SEMICONDUCTORS, Via Casati, 23 - 20052 MONZA (MI),  
Tel. +39 039 203 6838, Fax +39 039 203 6800

**Japan:** Philips Bldg 13-37, Kohnan 2-chome, Minato-ku,  
TOKYO 108-8507, Tel. +81 3 3740 5130, Fax. +81 3 3740 5057

**Korea:** Philips House, 260-199 Itaewon-dong, Yongsan-ku, SEOUL,  
Tel. +82 2 709 1412, Fax. +82 2 709 1415

**Malaysia:** No. 76 Jalan Universiti, 46200 PETALING JAYA, SELANGOR,  
Tel. +60 3 750 5214, Fax. +60 3 757 4880

**Mexico:** 5900 Gateway East, Suite 200, EL PASO, TEXAS 79905,  
Tel. +9-5 800 234 7381, Fax +9-5 800 943 0087

**Middle East:** see Italy

**Netherlands:** Postbus 90050, 5600 PB EINDHOVEN, Bldg. VB,  
Tel. +31 40 27 82785, Fax. +31 40 27 88399

**New Zealand:** 2 Wagener Place, C.P.O. Box 1041, AUCKLAND,  
Tel. +64 9 849 4160, Fax. +64 9 849 7811

**Norway:** Box 1, Manglerud 0612, OSLO,  
Tel. +47 22 74 8000, Fax. +47 22 74 8341

**Pakistan:** see Singapore

**Philippines:** Philips Semiconductors Philippines Inc.,  
106 Valero St. Salcedo Village, P.O. Box 2108 MCC, MAKATI,  
Metro MANILA, Tel. +63 2 816 6380, Fax. +63 2 817 3474

**Poland:** Al.Jerozolimskie 195 B, 02-222 WARSAW,  
Tel. +48 22 5710 000, Fax. +48 22 5710 001

**Portugal:** see Spain

**Romania:** see Italy

**Russia:** Philips Russia, Ul. Usatcheva 35A, 119048 MOSCOW,  
Tel. +7 095 755 6918, Fax. +7 095 755 6919

**Singapore:** Lorong 1, Toa Payoh, SINGAPORE 319762,  
Tel. +65 350 2538, Fax. +65 251 6500

**Slovakia:** see Austria

**Slovenia:** see Italy

**South Africa:** S.A. PHILIPS Pty Ltd., 195-215 Main Road Martindale,  
2092 JOHANNESBURG, P.O. Box 58088 Newville 2114,  
Tel. +27 11 471 5401, Fax. +27 11 471 5398

**South America:** Al. Vicente Pinzon, 173, 6th floor,  
04547-130 SÃO PAULO, SP, Brazil,  
Tel. +55 11 821 2333, Fax. +55 11 821 2382

**Spain:** Balmes 22, 08007 BARCELONA,  
Tel. +34 93 301 6312, Fax. +34 93 301 4107

**Sweden:** Kottbygatan 7, Akalla, S-16485 STOCKHOLM,  
Tel. +46 8 5985 2000, Fax. +46 8 5985 2745

**Switzerland:** Allmendstrasse 140, CH-8027 ZÜRICH,  
Tel. +41 1 488 2741 Fax. +41 1 488 3263

**Taiwan:** Philips Semiconductors, 6F, No. 96, Chien Kuo N. Rd., Sec. 1,  
TAIPEI, Taiwan Tel. +886 2 2134 2886, Fax. +886 2 2134 2874

**Thailand:** PHILIPS ELECTRONICS (THAILAND) Ltd.,  
209/2 Sanpavuth-Bangna Road Prakanong, BANGKOK 10260,  
Tel. +66 2 745 4090, Fax. +66 2 398 0793

**Turkey:** Yukari Dudullu, Org. San. Blg., 2.Cad. Nr. 28 81260 Umraniye,  
ISTANBUL, Tel. +90 216 522 1500, Fax. +90 216 522 1813

**Ukraine:** PHILIPS UKRAINE, 4 Patrice Lumumba str., Building B, Floor 7,  
252042 KIEV, Tel. +380 44 264 2776, Fax. +380 44 268 0461

**United Kingdom:** Philips Semiconductors Ltd., 276 Bath Road, Hayes,  
MIDDLESEX UB3 5BX, Tel. +44 208 730 5000, Fax. +44 208 754 8421

**United States:** 811 East Arques Avenue, SUNNYVALE, CA 94088-3409,  
Tel. +1 800 234 7381, Fax. +1 800 943 0087

**Uruguay:** see South America

**Vietnam:** see Singapore

**Yugoslavia:** PHILIPS, Trg N. Pasica 5/v, 11000 BEOGRAD,  
Tel. +381 11 3341 299, Fax.+381 11 3342 553

**For all other countries apply to:** Philips Semiconductors,  
International Marketing & Sales Communications, Building BE-p, P.O. Box 218,  
5600 MD EINDHOVEN, The Netherlands, Fax. +31 40 27 24825

**Internet:** <http://www.semiconductors.philips.com>

© Philips Electronics N.V. 2000

SCA 69

All rights are reserved. Reproduction in whole or in part is prohibited without the prior written consent of the copyright owner.

The information presented in this document does not form part of any quotation or contract, is believed to be accurate and reliable and may be changed without notice. No liability will be accepted by the publisher for any consequence of its use. Publication thereof does not convey nor imply any license under patent- or other industrial or intellectual property rights.

Printed in The Netherlands

245004/01/pp16

Date of release: 2000 Mar 07

Document order number: 9397 750 06736

*Let's make things better.*

**Philips**  
Semiconductors



**PHILIPS**