

FEATURES

- Low offset voltage: 65 μV max
- Single-supply operation: 2.7 V to 5.5 V
- Low noise: 8 nV/ $\sqrt{\text{Hz}}$
- Wide bandwidth: >20 MHz
- Slew rate: 12 V/ μs
- High output current: 150 mA
- No phase reversal
- Low input bias current: 1 pA
- Low supply current: 2 mA
- Unity gain stable

APPLICATIONS

- Barcode scanners
- Battery-powered instrumentation
- Multipole filters
- Sensors
- ASIC input or output amplifier
- Audio
- Photodiode amplification

GENERAL DESCRIPTION

The AD8616/AD8618 are dual/quad, rail-to-rail, input and output, single-supply amplifiers featuring very low offset voltage, wide signal bandwidth, and low input voltage and current noise. The parts use a patented trimming technique that achieves superior precision without laser trimming. The AD8616/AD8618 are fully specified to operate from 2.7 V to 5 V single supplies.

The combination of 20 MHz bandwidth, low offset, low noise, and very low input bias current make these amplifiers useful in a wide variety of applications. Filters, integrators, photodiode amplifiers, and high impedance sensors all benefit from the combination of performance features. AC applications benefit from the wide bandwidth and low distortion. The AD8616/AD8618 offer the highest output drive capability of the

Rev. A

Information furnished by Analog Devices is believed to be accurate and reliable. However, no responsibility is assumed by Analog Devices for its use, nor for any infringements of patents or other rights of third parties that may result from its use. Specifications subject to change without notice. No license is granted by implication or otherwise under any patent or patent rights of Analog Devices. Trademarks and registered trademarks are the property of their respective owners.

PIN CONFIGURATIONS

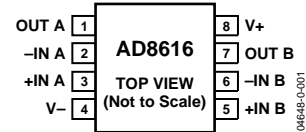

Figure 1. 8-Lead MSOP (RM-8)

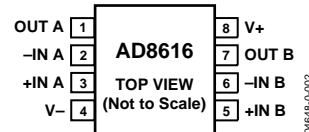

Figure 2. 8-Lead SOIC (R-8)

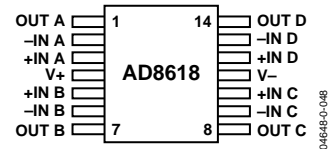

Figure 3. 14-Lead TSSOP (RU-14)

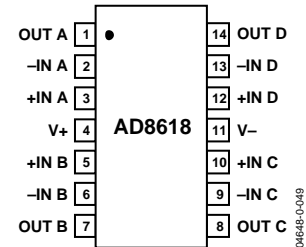

Figure 4. 14-Lead SOIC (R-14)

DigiTrim™ family, which is excellent for audio line drivers and other low impedance applications.

Applications for the parts include portable and low powered instrumentation, audio amplification for portable devices, portable phone headsets, bar code scanners, and multipole filters. The ability to swing rail to rail at both the input and output enables designers to buffer CMOS ADCs, DACs, ASICs, and other wide output swing devices in single-supply systems.

The AD8616/AD8618 are specified over the extended industrial (-40°C to $+125^{\circ}\text{C}$) temperature range. The AD8616 is available in 8-lead MSOP and narrow SOIC surface mount packages; the MSOP version is available in tape and reel only. The AD8618 is available in 14-lead SOIC and 14-lead TSSOP packages.

TABLE OF CONTENTS

Specifications.....	3	Driving Capacitive Loads.....	12
$V_s = 5\text{ V}$	3	Overload Recovery Time.....	13
$V_s = 2.7\text{ V}$	4	D/A Conversion.....	13
Absolute Maximum Ratings.....	5	Low Noise Applications.....	13
Thermal Resistance.....	5	High Speed Photodiode Preamplifier.....	14
ESD Caution.....	5	Active Filters.....	14
Typical Performance Characteristics.....	6	Power Dissipation.....	14
Applications.....	12	Power Calculations for Varying or Unknown Loads.....	15
Input Overvoltage Protection.....	12	Outline Dimensions.....	16
Output Phase Reversal.....	12	Ordering Guide.....	16

REVISION HISTORY

4/04—Data Sheet Changed from Rev. 0 to Rev. A

Added AD8618.....	Universal
Updated Outline Dimensions.....	16

1/04—Revision 0: Initial Version

SPECIFICATIONS

$V_S = 5\text{ V}$

@ $V_{CM} = V_S/2$, $T_A = 25^\circ\text{C}$, unless otherwise noted.

Table 1.

Parameter	Symbol	Conditions	Min	Typ	Max	Unit
INPUT CHARACTERISTICS						
Offset Voltage	V_{OS}	$V_S = 3.5\text{ V}$ @ $V_{CM} = 0.5\text{ V}$ and 3.0 V $V_{CM} = 0\text{ V}$ to 5 V $-40^\circ\text{C} < T_A < +125^\circ\text{C}$		23 80	65 500	μV μV
Offset Voltage Drift	$\Delta V_{OS}/\Delta T$	$-40^\circ\text{C} < T_A < +125^\circ\text{C}$		1.5	7	$\mu\text{V}/^\circ\text{C}$
Input Bias Current	I_B	$-40^\circ\text{C} < T_A < +85^\circ\text{C}$ $-40^\circ\text{C} < T_A < +125^\circ\text{C}$		0.2	1 50	pA pA
Input Offset Current	I_{OS}	$-40^\circ\text{C} < T_A < +85^\circ\text{C}$ $-40^\circ\text{C} < T_A < +125^\circ\text{C}$		0.1	0.5 50 250	pA pA pA
Input Voltage Range			0		5	V
Common-Mode Rejection Ratio	CMRR	$V_{CM} = 0\text{ V}$ to 4.5 V	80	100		dB
Large Signal Voltage Gain	A_{VO}	$R_L = 2\text{ k}\Omega$, $V_O = 0.5\text{ V}$ to 5 V	105	1500		V/mV
Input Capacitance	C_{DIFF} C_{CM}			2.6 10		pF pF
OUTPUT CHARACTERISTICS						
Output Voltage High	V_{OH}	$I_L = 1\text{ mA}$ $I_L = 10\text{ mA}$ $-40^\circ\text{C} < T_A < +125^\circ\text{C}$	4.98 4.88 4.7	4.99 4.92		V V V
Output Voltage Low	V_{OL}	$I_L = 1\text{ mA}$ $I_L = 10\text{ mA}$ $-40^\circ\text{C} < T_A < +125^\circ\text{C}$		7.5 70	15 100 200	mV mV mV
Output Current	I_{OUT}			± 150		mA
Closed-Loop Output Impedance	Z_{OUT}	$f = 1\text{ MHz}$, $A_V = 1$		3		Ω
POWER SUPPLY						
Power Supply Rejection Ratio	PSRR	$V_S = 2.7\text{ V}$ to 5.5 V	70	90		dB
Supply Current per Amplifier	I_{SY}	$V_O = 0\text{ V}$ $-40^\circ\text{C} < T_A < +125^\circ\text{C}$		1.7	2.0 2.5	mA mA
DYNAMIC PERFORMANCE						
Slew Rate	SR	$R_L = 2\text{ k}\Omega$		12		V/ μs
Settling Time	t_s	To 0.01%		<0.5		μs
Gain Bandwidth Product	GBP			24		MHz
Phase Margin	ϕ_o			73		Degrees
NOISE PERFORMANCE						
Peak-to-Peak Noise	$e_n\text{ p-p}$	0.1 Hz to 10 Hz		2.4		μV
Voltage Noise Density	e_n	$f = 1\text{ kHz}$ $f = 10\text{ kHz}$		8 6		$\text{nV}/\sqrt{\text{Hz}}$ $\text{nV}/\sqrt{\text{Hz}}$
Current Noise Density	i_n	$f = 1\text{ kHz}$		0.05		$\text{pA}/\sqrt{\text{Hz}}$
Channel Separation	C_s	$f = 10\text{ kHz}$ $f = 100\text{ kHz}$		-115 -110		dB dB

AD8616/AD8618

V_S = 2.7 V

@V_{CM} = V_S / 2, T_A = 25°C, unless otherwise noted.

Table 2.

Parameter	Symbol	Conditions	Min	Typ	Max	Unit
INPUT CHARACTERISTICS						
Offset Voltage	V _{OS}	V _S = 3.5 V @ V _{CM} = 0.5 V and 3.0 V V _{CM} = 0 V to 2.7 V −40°C < T _A < +125°C		23 80	65 500	μV μV
Offset Voltage Drift	ΔV _{OS} /ΔT	−40°C < T _A < +125°C		1.5	7	μV/°C
Input Bias Current	I _B	−40°C < T _A < +85°C −40°C < T _A < +125°C		0.2	1 50	pA pA
Input Offset Current	I _{OS}	−40°C < T _A < +85°C −40°C < T _A < +125°C		0.1	0.5 50 250	pA pA pA
Input Voltage Range			0		2.7	V
Common-Mode Rejection Ratio	CMRR	V _{CM} = 0 V to 2.7 V	84	100		dB
Large Signal Voltage Gain	A _{VO}	R _L = 2 kΩ, V _O = 0.5 V to 2.2 V	55	150		V/mV
Input Capacitance	C _{DIFF} C _{CM}			2.6 10		pF pF
OUTPUT CHARACTERISTICS						
Output Voltage High	V _{OH}	I _L = 1 mA −40°C < T _A < +125°C	2.65 2.6	2.68		V V
Output Voltage Low	V _{OL}	I _L = 1 mA −40°C < T _A < +125°C		11	25 30	mV mV
Output Current	I _{OUT}			±50		mA
Closed-Loop Output Impedance	Z _{OUT}	f = 1 MHz, A _V = 1		3		Ω
POWER SUPPLY						
Power Supply Rejection Ratio	PSRR	V _S = 2.7 V to 5.5 V	70	90		dB
Supply Current per Amplifier	I _{SY}	V _O = 0 V −40°C < T _A < +125°C		1.7	2 2.5	mA mA
DYNAMIC PERFORMANCE						
Slew Rate	SR	R _L = 2 kΩ		12		V/μs
Settling Time	t _s	To 0.01%		<0.3		μs
Gain Bandwidth Product	GBP			22		MHz
Phase Margin	∅ _O			50		Degrees
NOISE PERFORMANCE						
Peak-to-Peak Noise	e _n p-p	0.1 Hz to 10 Hz		2.1		μV
Voltage Noise Density	e _n	f = 1 kHz		8		nV/√Hz
		f = 10 kHz		6		nV/√Hz
Current Noise Density	i _n	f = 1 kHz		0.05		pA/√Hz
Channel Separation	C _S	f = 10 kHz		−115		dB
		f = 100 kHz		−110		dB

ABSOLUTE MAXIMUM RATINGS

Table 3. AD8616/AD8618 Stress Ratings

Parameter	Rating
Supply Voltage	6 V
Input Voltage	GND to V_S
Differential Input Voltage	± 3 V
Output Short-Circuit Duration to GND	Indefinite
Storage Temperature	-65°C to $+150^\circ\text{C}$
Operating Temperature Range	-40°C to $+125^\circ\text{C}$
Lead Temperature Range (Soldering 60 sec)	300°C
Junction Temperature	150°C

Stresses above those listed under Absolute Maximum Ratings may cause permanent damage to the device. This is a stress rating only; functional operation of the device at these or any other conditions above those indicated in the operational section of this specification is not implied. Exposure to absolute maximum rating conditions for extended periods may affect device reliability.

ESD CAUTION

ESD (electrostatic discharge) sensitive device. Electrostatic charges as high as 4000 V readily accumulate on the human body and test equipment and can discharge without detection. Although this product features proprietary ESD protection circuitry, permanent damage may occur on devices subjected to high energy electrostatic discharges. Therefore, proper ESD precautions are recommended to avoid performance degradation or loss of functionality.



THERMAL RESISTANCE

θ_{JA} is specified for the worst-case conditions, i.e., θ_{JA} is specified for device soldered in circuit board for surface-mount packages.

Table 4.

Package Type	θ_{JA}	θ_{JC}	Unit
8-Lead MSOP (RM)	210	45	$^\circ\text{C}/\text{W}$
8-Lead SOIC (R)	158	43	$^\circ\text{C}/\text{W}$
14-Lead SOIC (R)	120	36	$^\circ\text{C}/\text{W}$
14-Lead TSSOP (RU)	180	35	$^\circ\text{C}/\text{W}$

TYPICAL PERFORMANCE CHARACTERISTICS

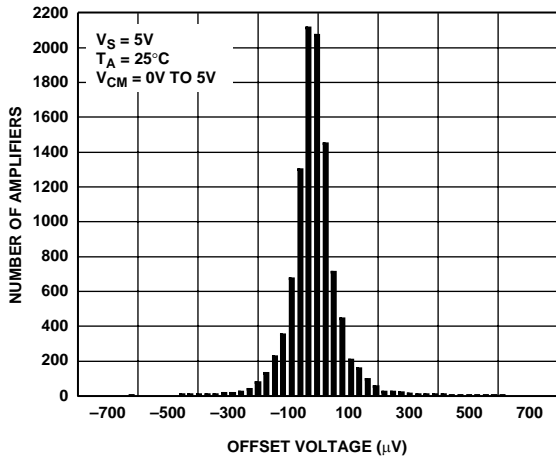

Figure 5. Input Offset Voltage Distribution

04648-0-003

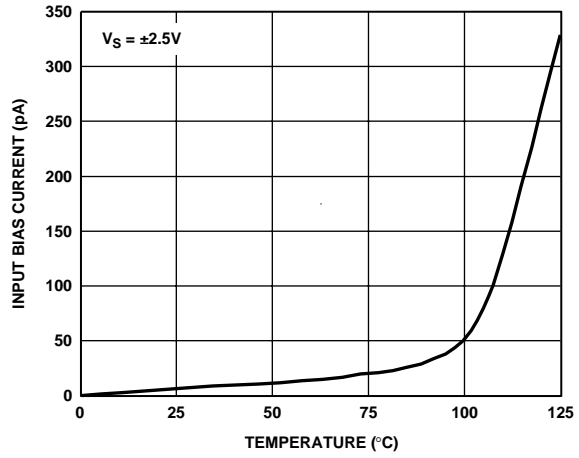

Figure 8. Input Bias Current vs. Temperature

04648-0-006

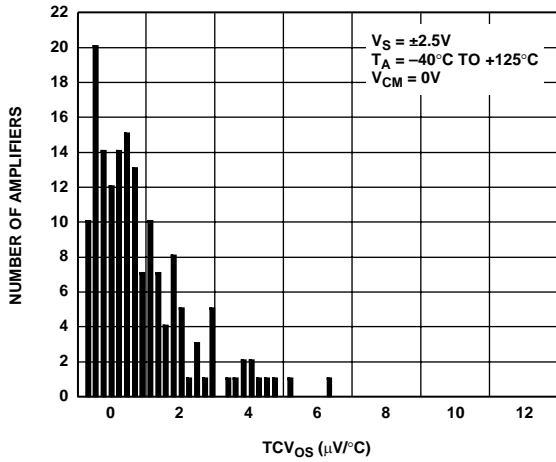

Figure 6. Offset Voltage Drift Distribution

04648-0-004

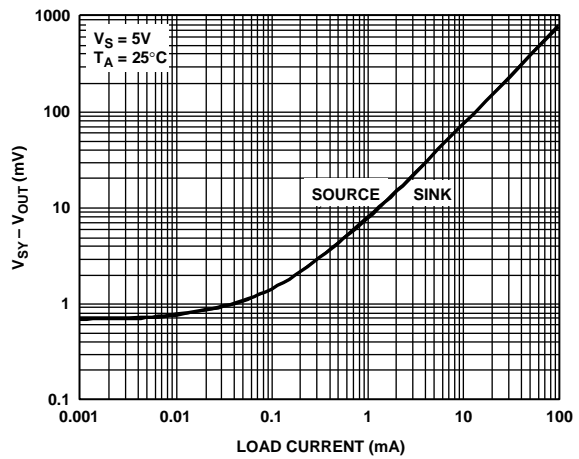

Figure 9. Output Voltage to Supply Rail vs. Load Current

04648-0-007

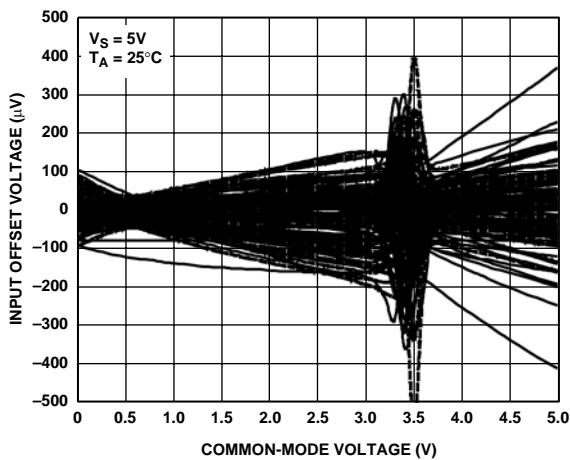

Figure 7. Input Offset Voltage vs. Common-Mode Voltage (200 Units, Five Wafer Lots Including Process Skews)

04648-0-005

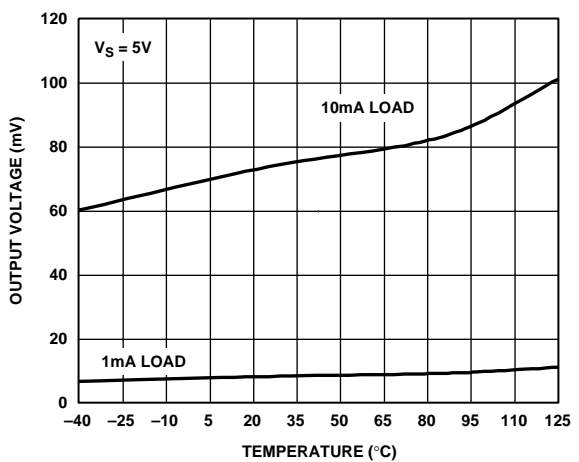

Figure 10. Output Voltage Swing vs. Temperature

04648-0-008

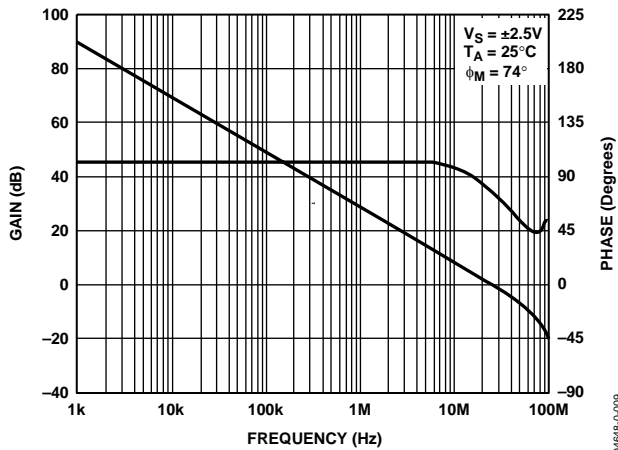

Figure 11. Open-Loop Gain and Phase vs. Frequency

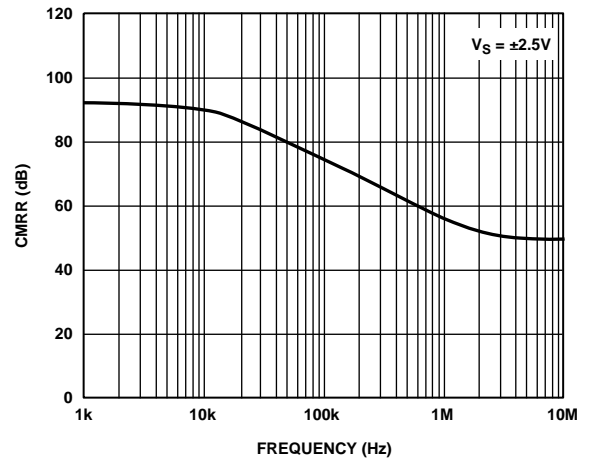

Figure 14. Common-Mode Rejection Ratio vs. Frequency

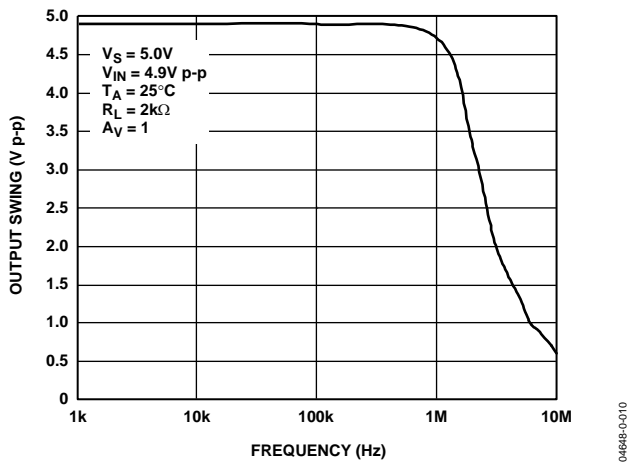

Figure 12. Closed-Loop Output Voltage Swing

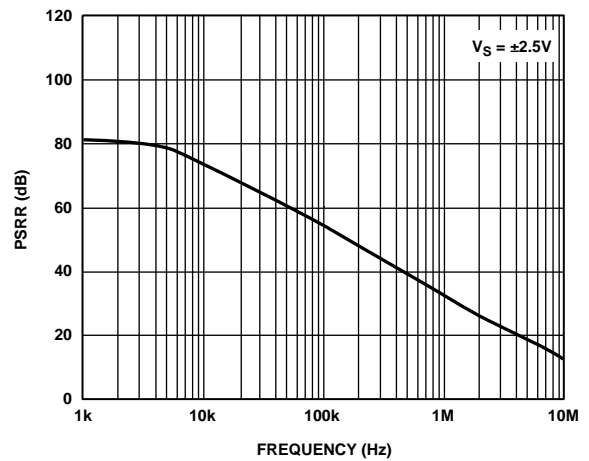

Figure 15. PSRR vs. Frequency

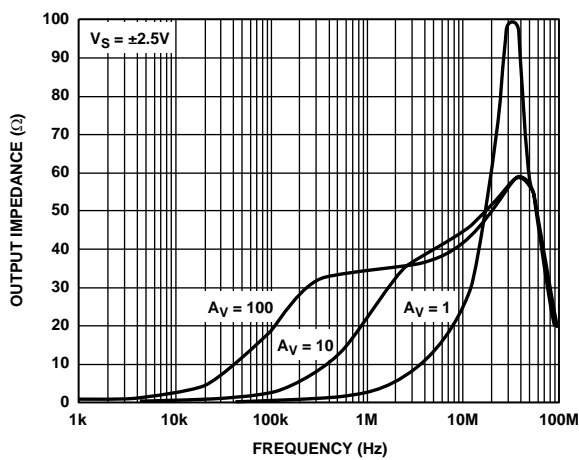

Figure 13. Output Impedance vs. Frequency

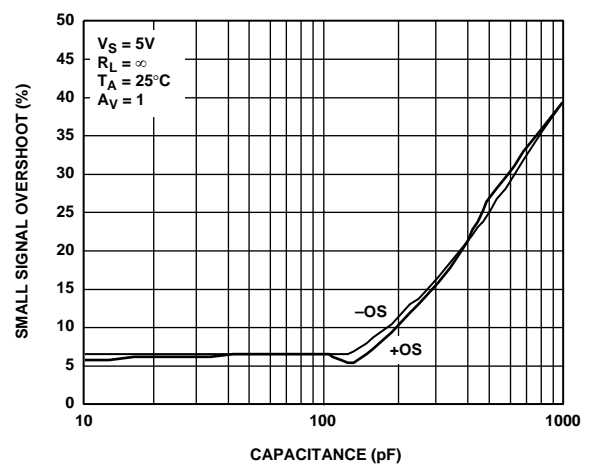

Figure 16. Small-Signal Overshoot vs. Load Capacitance

AD8616/AD8618

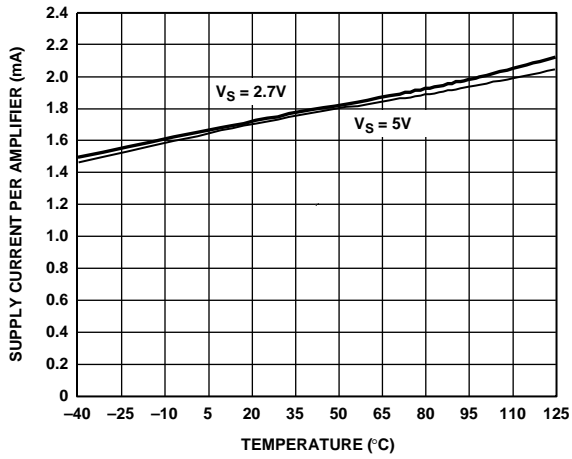

Figure 17. Supply Current vs. Temperature

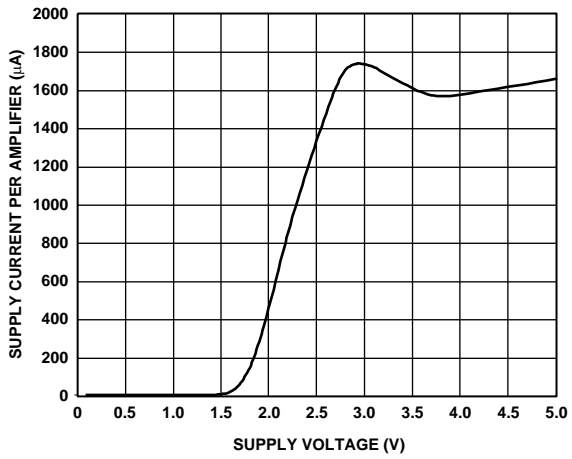

Figure 18. Supply Current vs. Supply Voltage

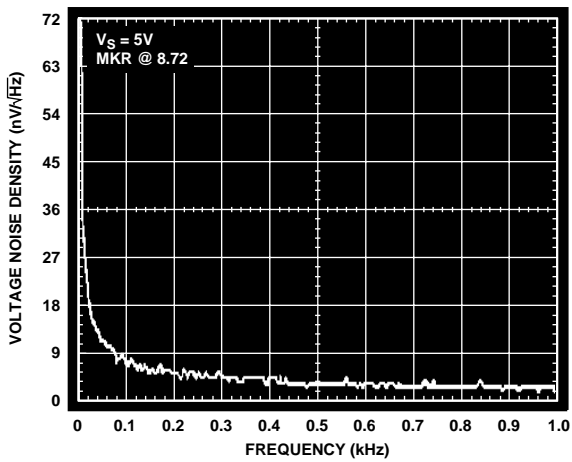

Figure 19. Voltage Noise Density vs. Frequency

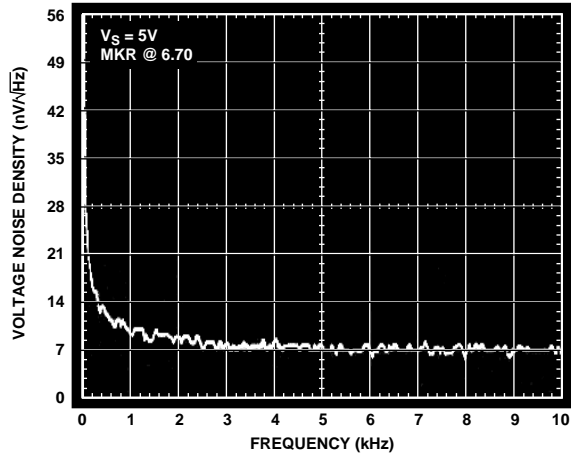

Figure 20. Voltage Noise Density vs. Frequency

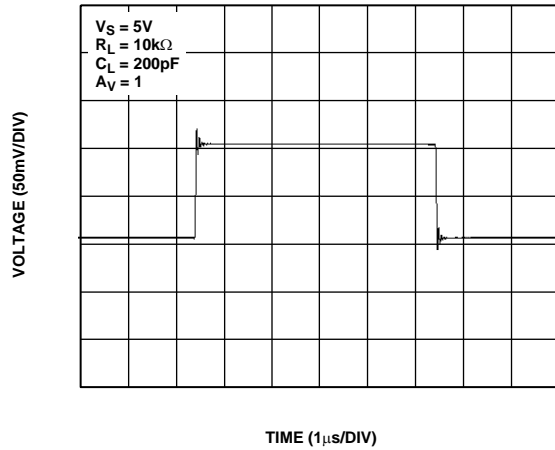

Figure 21. Small-Signal Transient Response

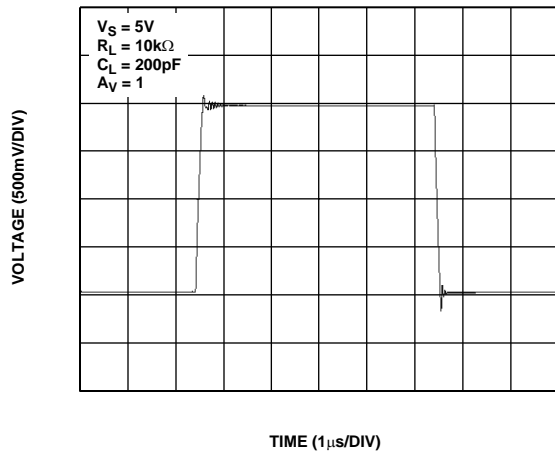

Figure 22. Large-Signal Transient Response

04648-0-015

04648-0-016

04648-0-017

04648-0-018

04648-0-019

04648-0-020

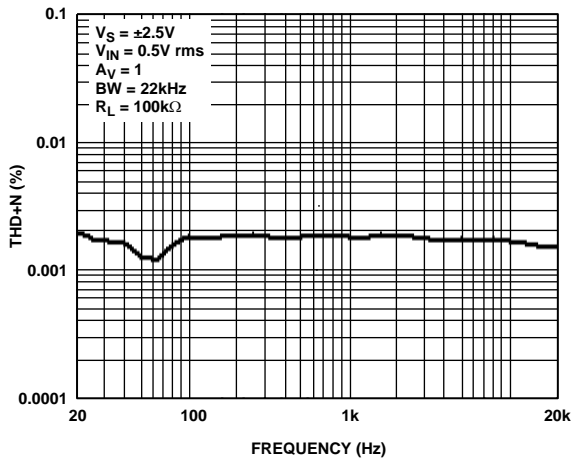

Figure 23. THD + N

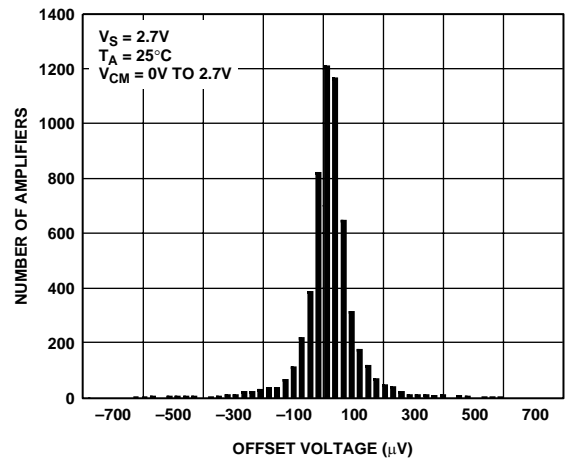

Figure 26. Input Offset Voltage Distribution

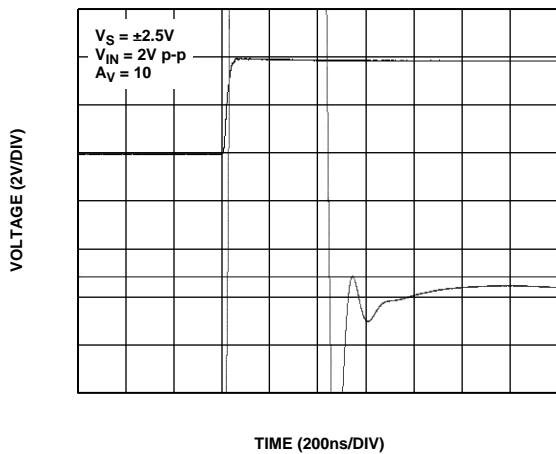

Figure 24. Settling Time

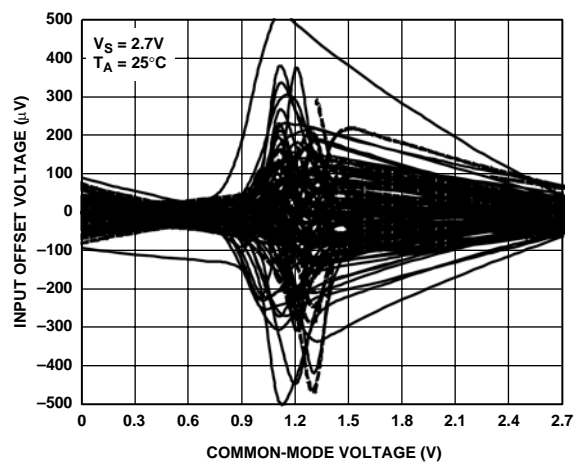

Figure 27. Input Offset Voltage vs. Common-Mode Voltage (200 Units, Five Wafer Lots Including Process Skews)

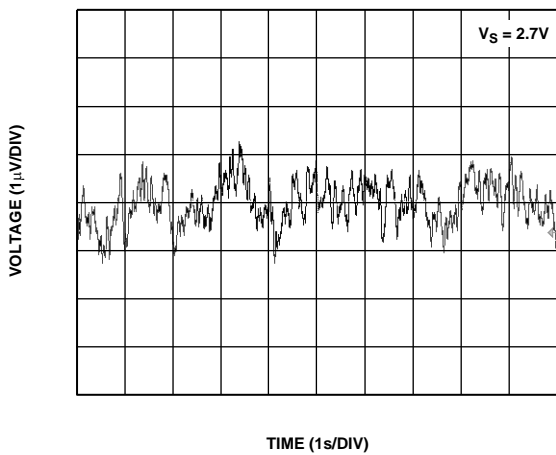

Figure 25. 0.1 Hz to 10 Hz Input Voltage Noise

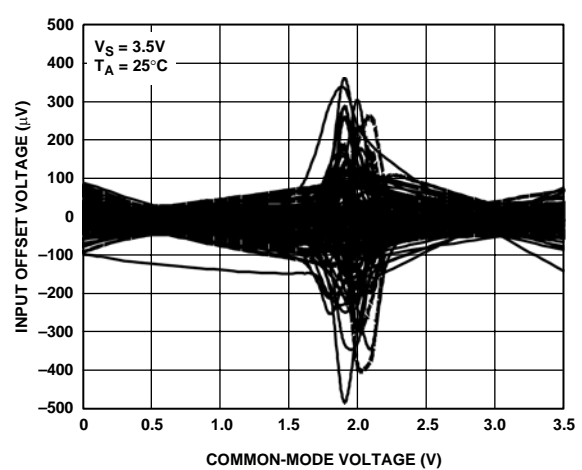

Figure 28. Input Offset Voltage vs. Common-Mode Voltage (200 Units, Five Wafer Lots Including Process Skews)

04648-0-021

04648-0-024

04648-0-022

04648-0-025

04648-0-023

04648-0-026

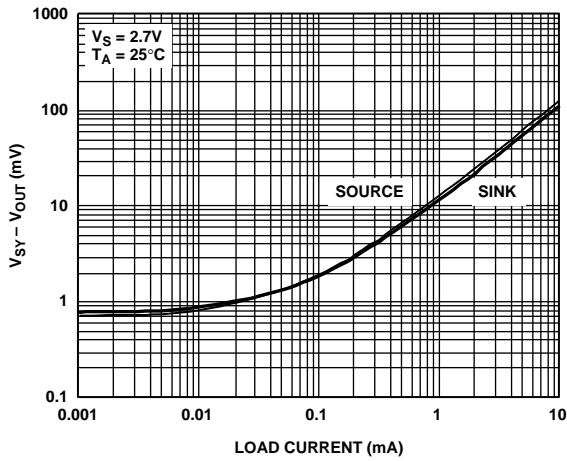

Figure 29. Output Voltage to Supply Rail vs. Load Current

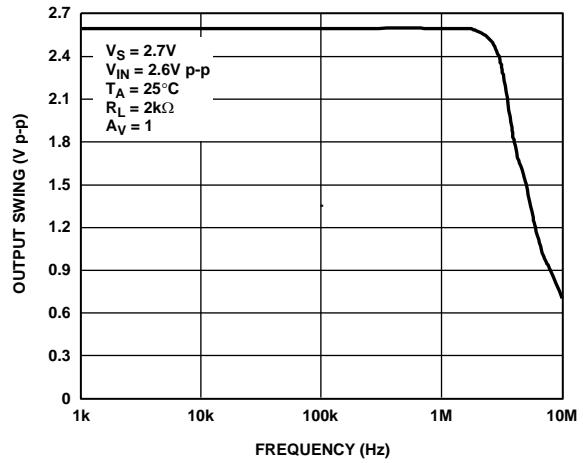

Figure 32. Closed-Loop Output Voltage Swing vs. Frequency

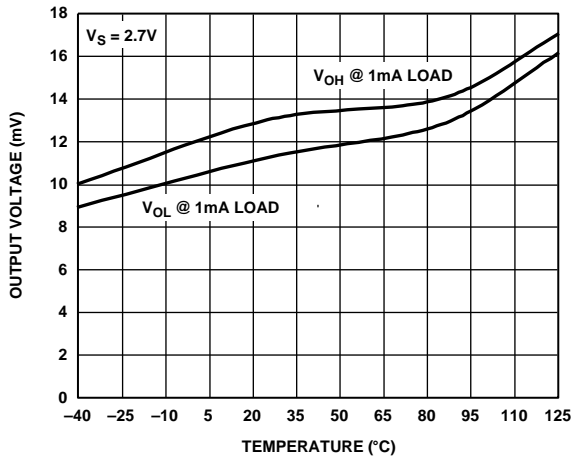

Figure 30. Output Voltage Swing vs. Temperature

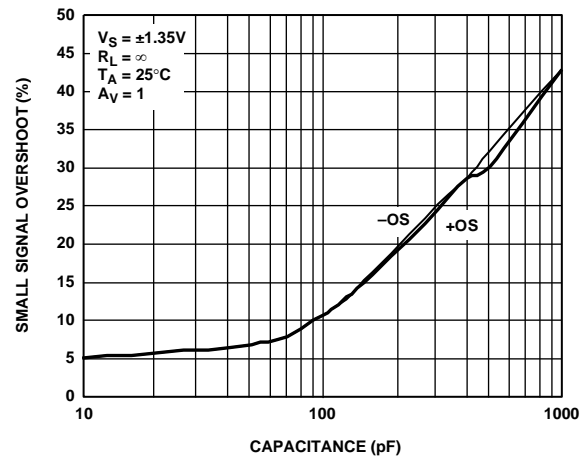

Figure 33. Small-Signal Overshoot vs. Load Capacitance

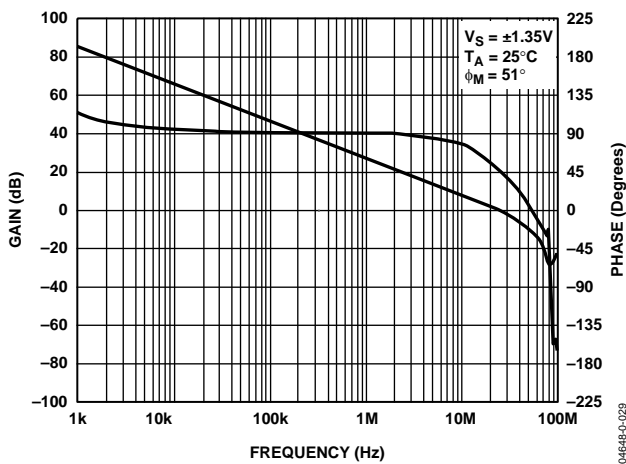

Figure 31. Open-Loop Gain and Phase vs. Frequency

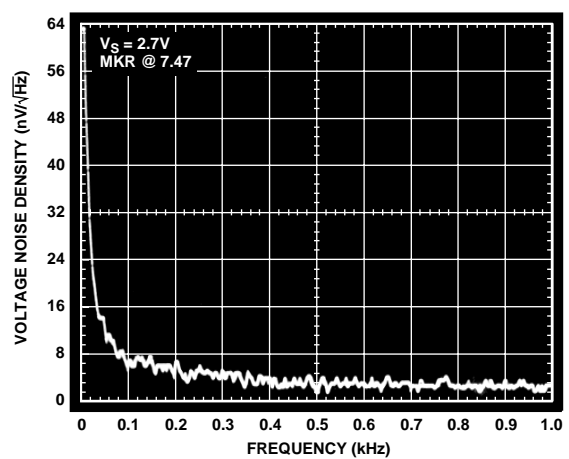

Figure 34. Voltage Noise Density vs. Frequency

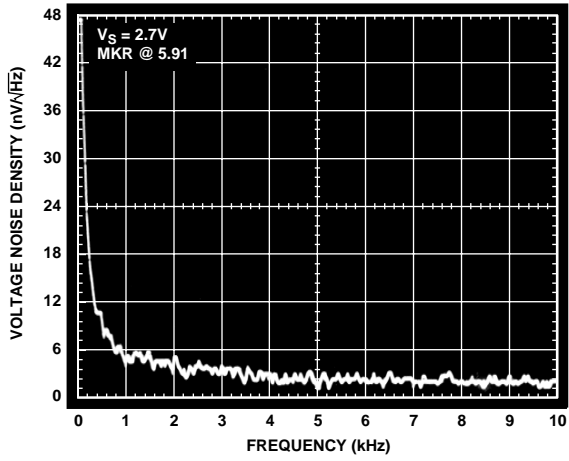

Figure 35. Voltage Noise Density vs. Frequency

04648-0-033

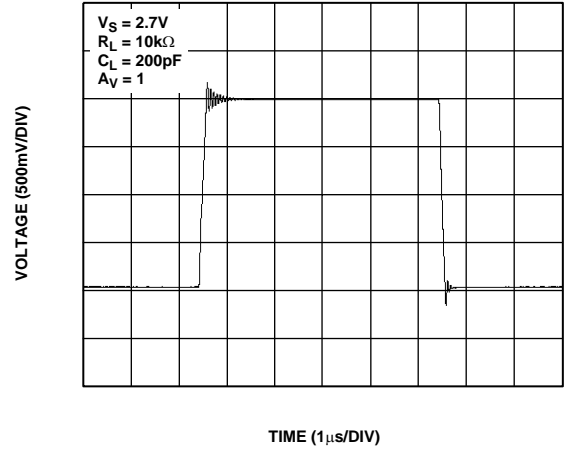

Figure 37. Large-Signal Transient Response

04648-0-035

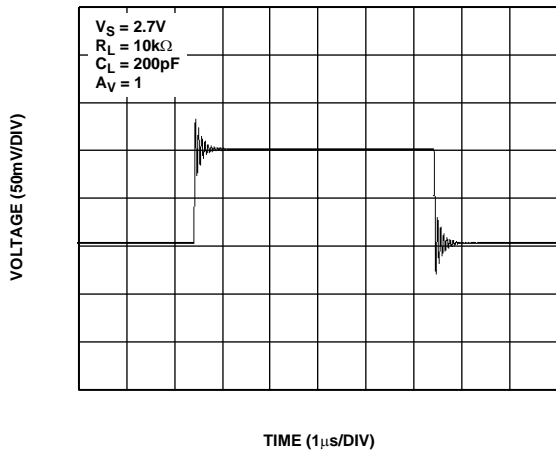

Figure 36. Small-Signal Transient Response

04648-0-034

APPLICATIONS

INPUT OVERVOLTAGE PROTECTION

The AD8616/AD8618 have internal protective circuitry that allows voltages exceeding the supply to be applied at the input.

It is recommended, however, not to apply voltages that exceed the supplies by more than 1.5 V at either input of the amplifier. If a higher input voltage is applied, series resistors should be used to limit the current flowing into the inputs.

The input current should be limited to <5 mA. The extremely low input bias current allows the use of larger resistors, which allows the user to apply higher voltages at the inputs. The use of these resistors adds thermal noise, which contributes to the overall output voltage noise of the amplifier.

For example, a 10 kΩ resistor has less than 13 nV/√Hz of thermal noise and less than 10 nV of error voltage at room temperature.

OUTPUT PHASE REVERSAL

The AD8616/AD8618 are immune to phase inversion, a phenomenon that occurs when the voltage applied at the input of the amplifier exceeds the maximum input common mode.

Phase reversal can cause permanent damage to the amplifier and lock-ups to systems with feedback loops.

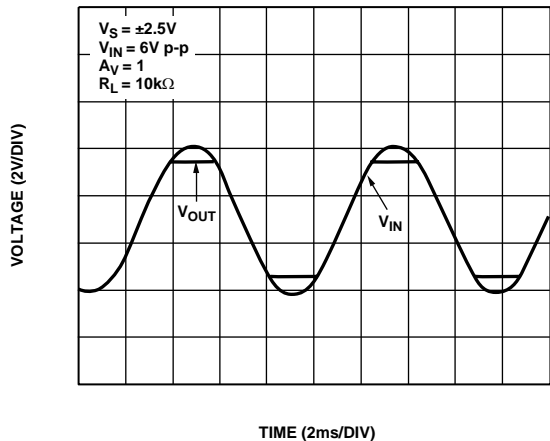

Figure 38. No Phase Reversal

DRIVING CAPACITIVE LOADS

Although the AD8616/AD8618 are capable of driving capacitive loads of up to 500 pF without oscillating, a large amount of overshoot is present when operating at frequencies above 100 kHz. This is especially true when the amplifier is configured in positive unity gain (worst case). When such large capacitive loads are required, the use of external compensation is highly recommended. This reduces the overshoot and minimizes ringing, which in turn improves the frequency response of the

AD8616/AD8618. One simple technique for compensation is the snubber, which consists of a simple RC network. With this circuit in place, output swing is maintained and the amplifier is stable at all gains.

Figure 40 shows the implementation of the snubber, which reduces overshoot by more than 30% and eliminates ringing, which can cause instability. Using the snubber does not recover the loss of bandwidth incurred from a heavy capacitive load.

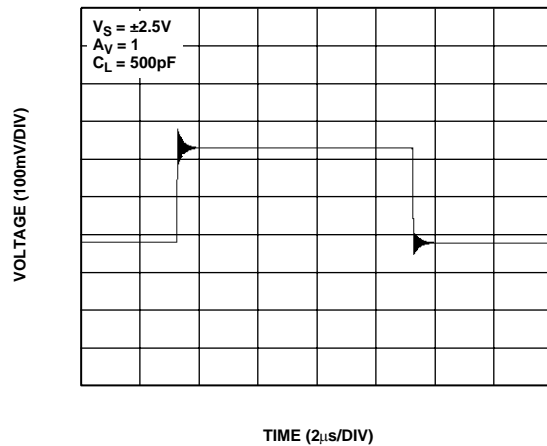

Figure 39. Driving Heavy Capacitive Loads without Compensation

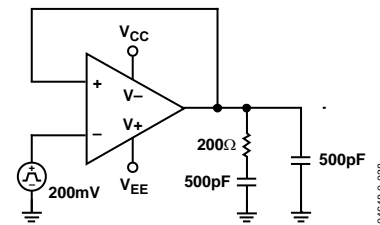

Figure 40. Snubber Network

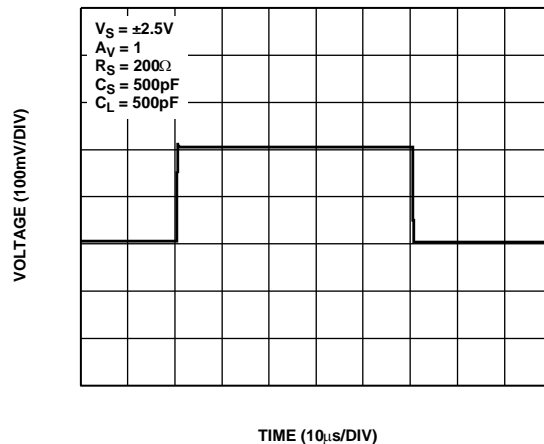

Figure 41. Driving Heavy Capacitive Loads Using the Snubber Network

OVERLOAD RECOVERY TIME

Overload recovery time is the time it takes the output of the amplifier to come out of saturation and recover to its linear region. Overload recovery is particularly important in applications where small signals must be amplified in the presence of large transients. Figure 42 and Figure 43 show the positive and negative overload recovery times of the AD8616. In both cases, the time elapsed before the AD8616 comes out of saturation is less than 1 μ s. In addition, the symmetry between the positive and negative recovery times allows for excellent signal rectification without distortion to the output signal.

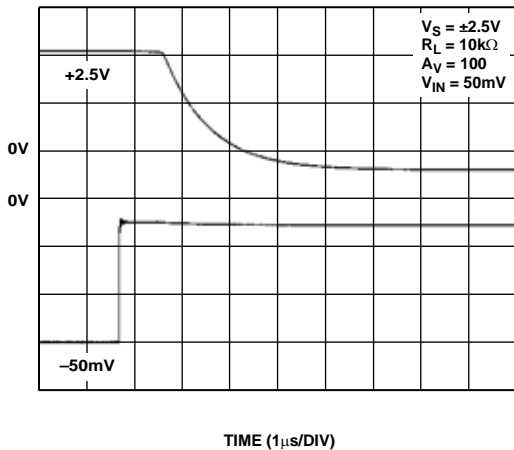

Figure 42. Positive Overload Recovery

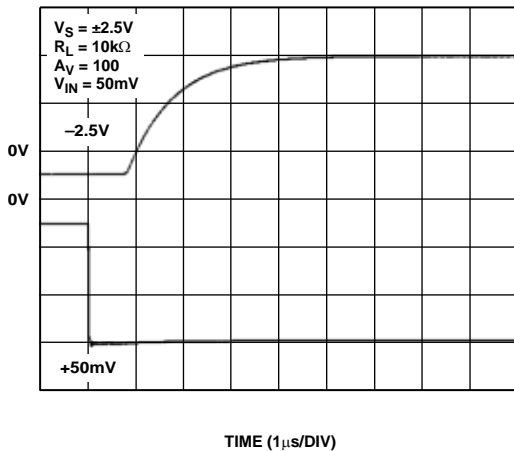

Figure 43. Negative Overload Recovery

D/A CONVERSION

The AD8616 can be used at the output of high resolution DACs. Their low offset voltage, fast slew rate, and fast settling time make the parts suitable to buffer voltage output or current output DACs.

Figure 44 shows an example of the AD8616 at the output of the AD5542. The AD8616's rail-to-rail output and low distortion help maintain the accuracy needed in data acquisition systems and automated test equipment.

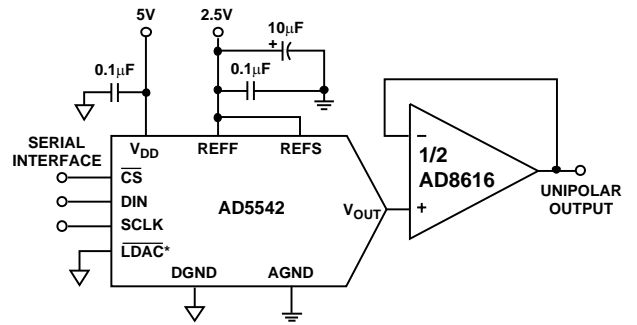

Figure 44. Buffering DAC Output

LOW NOISE APPLICATIONS

Although the AD8618 typically has less than 8 nV/ \sqrt{Hz} of voltage noise density at 1 kHz, it is possible to reduce it further. A simple method is to connect the amplifiers in parallel, as shown in Figure 45. The total noise at the output is divided by the square root of the number of amplifiers. In this case, the total noise is approximately 4 nV/ \sqrt{Hz} at room temperature. The 100 Ω resistor limits the current and provides an effective output resistance of 50 Ω .

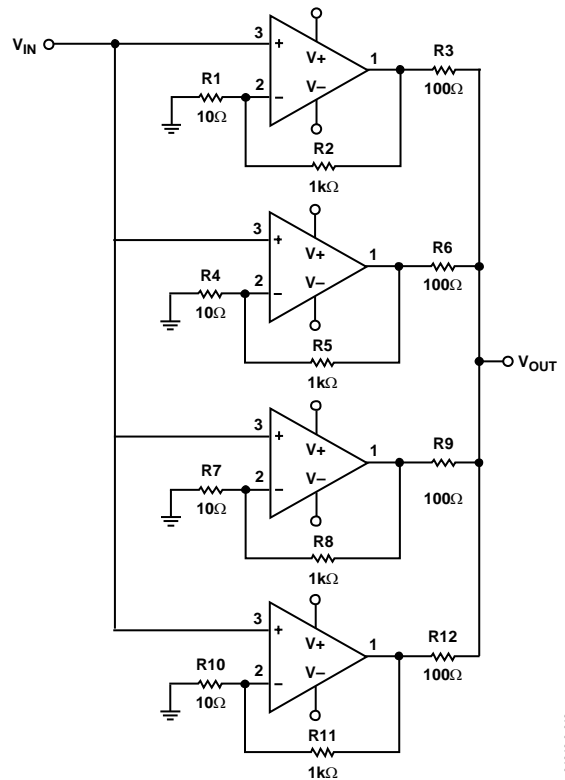

Figure 45. Noise Reduction

AD8616/AD8618

HIGH SPEED PHOTODIODE PREAMPLIFIER

The AD8616/AD8618 are excellent choices for I-to-V conversions. The very low input bias, low current noise, and high unity gain bandwidth of the parts make them suitable, especially for high speed photodiode preamps.

In high speed photodiode applications, the diode is operated in a photoconductive mode (reverse biased). This lowers the junction capacitance at the expense of an increase in the amount of dark current that flows out of the diode.

The total input capacitance, C_1 , is the sum of the diode capacitance and that of the op amp. This creates a feedback pole and causes degradation of the phase margin, making the op amp unstable. It is therefore necessary to use a capacitor in the feedback to compensate for this pole.

To get the maximum signal bandwidth, select

$$C_2 = \sqrt{\frac{C_1}{2\pi R_2 f_u}}$$

where f_u is the unity gain bandwidth of the amplifier.

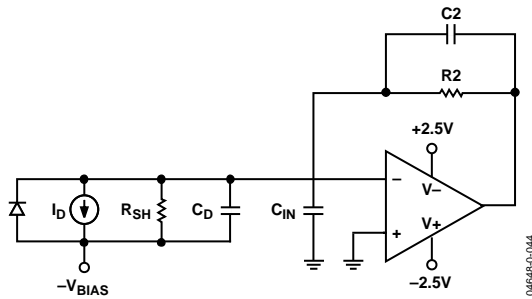

Figure 46. High Speed Photodiode Preamplifier

ACTIVE FILTERS

The low input bias current and high unity gain bandwidth of the AD8616 make it an excellent choice for precision filter design.

Figure 47 shows the implementation of a second-order low-pass filter. The Butterworth response has a corner frequency of 100 kHz and a phase shift of 90°. The frequency response is shown in Figure 48.

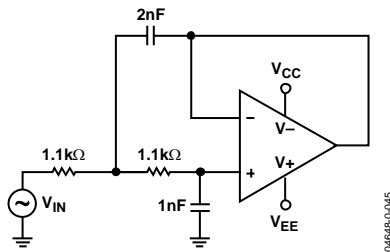

Figure 47. Second-Order Low-Pass Filter

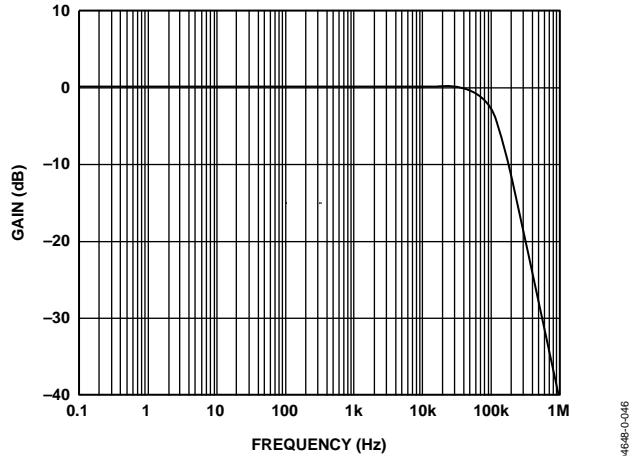

Figure 48. Second-Order Butterworth Low-Pass Filter Frequency Response

POWER DISSIPATION

Although the AD8616/AD8618 are capable of providing load currents to 150 mA, the usable output load current drive capability is limited to the maximum power dissipation allowed by the device package used. In any application, the absolute maximum junction temperature for the AD8616/AD8618 is 150°C; this should never be exceeded because the device could suffer premature failure. Accurately measuring power dissipation of an integrated circuit is not always a straightforward exercise; Figure 49 has been provided as a design aid for setting a safe output current drive level or selecting a heat sink for the package options available on the AD8616.

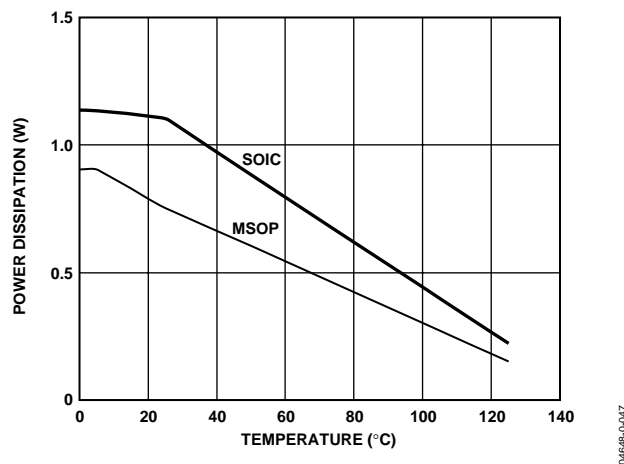

Figure 49. Maximum Power Dissipation vs. Ambient Temperature

These thermal resistance curves were determined using the AD8616 thermal resistance data for each package and a maximum junction temperature of 150°C. The following formula can be used to calculate the internal junction temperature of the AD8616/AD8618 for any application:

$$T_J = P_{DISS} \times \theta_{JA} + T_A$$

where:

T_J = junction temperature;

P_{DISS} = power dissipation;

θ_{JA} = package thermal resistance, junction-to-case; and

T_A = ambient temperature of the circuit.

To calculate the power dissipated by the AD8616/AD8618, use the following equation:

$$P_{DISS} = I_{LOAD} \times (V_S - V_{OUT})$$

where:

I_{LOAD} = output load current;

V_S = supply voltage; and

V_{OUT} = output voltage.

The quantity within the parentheses is the maximum voltage developed across either output transistor.

POWER CALCULATIONS FOR VARYING OR UNKNOWN LOADS

Often, calculating power dissipated by an integrated circuit to determine if the device is being operated in a safe range is not as simple as it might seem. In many cases, power cannot be directly measured. This may be the result of irregular output waveforms or varying loads; indirect methods of measuring power are required.

There are two methods to calculate power dissipated by an integrated circuit. The first can be done by measuring the package temperature and the board temperature. The other is to directly measure the circuit's supply current.

Calculating Power by Measuring Ambient and Case Temperature

Given the two equations for calculating junction temperature:

$$T_J = T_A + P \theta_{JA}$$

where:

T_J = junction temperature;

T_A = ambient temperature.

θ_{JA} = the junction-to-ambient thermal resistance.

$$T_J = T_C + P \theta_{JC}$$

where T_C is case temperature and θ_{JA} and θ_{JC} are given in the data sheet.

The two equations can be solved for P (power):

$$T_A + P \theta_{JA} = T_C + P \theta_{JC}$$

$$P = (T_A - T_C) / (\theta_{JC} - \theta_{JA})$$

Once power has been determined, it is necessary to go back and calculate the junction temperature to assure that it has not been exceeded.

The temperature measurements should be directly on the package and on a spot on the board that is near the package but not touching it. Measuring the package could be difficult. A very small bimetallic junction glued to the package could be used; an infrared sensing device could be used if the spot size is small enough.

Calculating Power by Measuring Supply Current

Power can be calculated directly if the supply voltage and current are known. However, supply current may have a dc component with a pulse into a capacitive load. This could make rms current very difficult to calculate. This can be overcome by lifting the supply pin and inserting an rms current meter into the circuit. For this to work, the user must be sure that all of the current is being delivered by the supply pin being measured. This is usually a good method in a single-supply system; however, if the system uses dual supplies, both supplies may need to be monitored.

OUTLINE DIMENSIONS

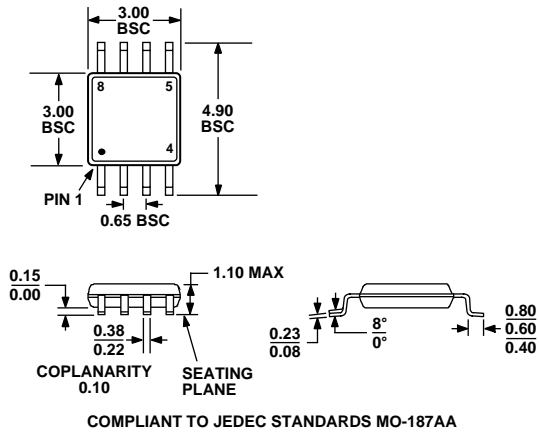

Figure 50. 8-Lead Micro Small Outline Package [MSOP] (RM-8)
Dimensions shown in millimeters

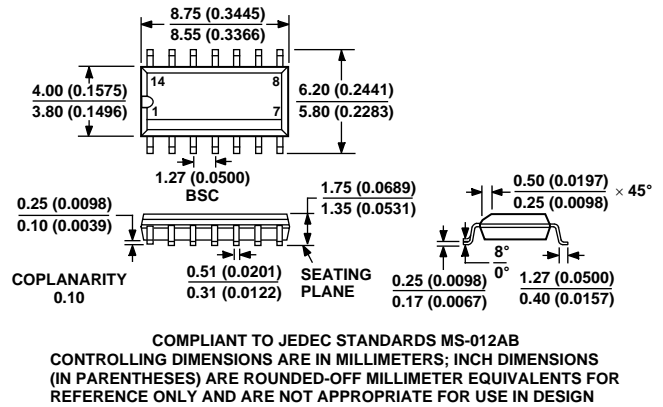

Figure 52. 14-Lead Standard Small Outline Package [SOIC] (R-14)
Dimensions shown in millimeters and (inches)

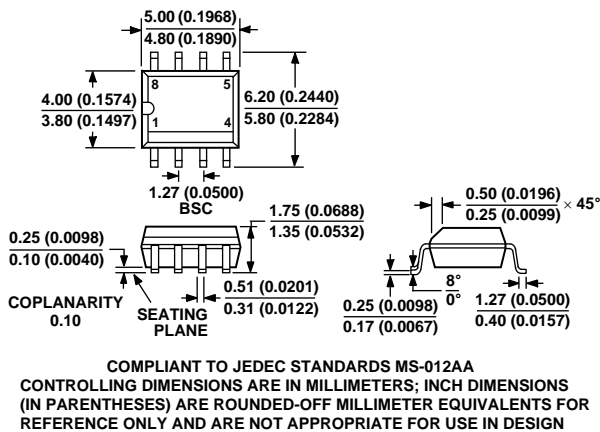

Figure 51. 8-Lead Standard Small Outline Package [SOIC] (R-8)
Dimensions shown in millimeters and (inches)

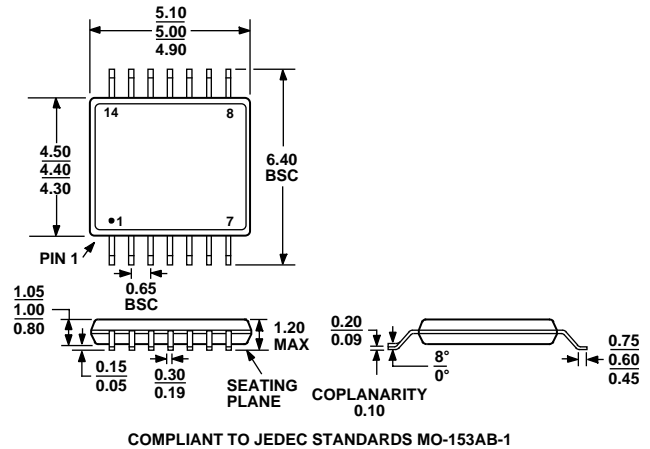

Figure 53. 14-Lead Thin Shrink Small Outline Package [TSSOP] (RU-14)
Dimensions shown in millimeters

ORDERING GUIDE

Model	Temperature Range	Package Description	Package Outline	Branding Code
AD8616ARM-R2	-40°C to +125°C	8-Lead MSOP	RM-8	BLA
AD8616ARM-REEL	-40°C to +125°C	8-Lead MSOP	RM-8	BLA
AD8616AR	-40°C to +125°C	8-Lead SOIC	R-8	
AD8616AR-REEL	-40°C to +125°C	8-Lead SOIC	R-8	
AD8616AR-REEL7	-40°C to +125°C	8-Lead SOIC	R-8	
AD8618AR	-40°C to +125°C	14-Lead SOIC	R-14	
AD8618AR-REEL	-40°C to +125°C	14-Lead SOIC	R-14	
AD8618AR-REEL7	-40°C to +125°C	14-Lead SOIC	R-14	
AD8618ARU	-40°C to +125°C	14-Lead TSSOP	RU-14	
AR8618ARU-REEL	-40°C to +125°C	14-Lead TSSOP	RU-14	